



**SUZUKI**

**26-27**  
**JAPANESE OUTBOARD**



# JAPANESE OUT- BOARD 2026

ICONS	ICONOS	ICONE	ICONES						
	Measures	Medida	Dimensione	Dimension		Units x bag	Unidades x bolsa	Unità x borsa	Unité x sachet
	Capacity	Capacidad	Capacità	Capacité		Units x Box	Unidades x Caja	Unità x Scatola	Unité x Carton
	Weight	Peso	Peso	Poids		Anode	Ánodo	Anodo	Anode
	Safe work	Trabajo seguro	Lavoro sicuro	Travailler en sécurité		Filter	Filtro	Filtro	Filtre
	Max. Load	Carga máxima	Caricca massima	Charge maximale		Bracket	Bracket	Supporto	Tête de filtre à essence
	Pressure	Presión	Presione	Pression		Filter Element	Elemento filtro	Elemento filtro	Cartouche de filtre
	Temperature	Temperatura	Temperatura	Température		Key	Llave	Chiave	Clé
	Power	Electricidad	Elettricità	Electricité		Key positions	Posiciones llave	Chiave, posizione	Clé, positions
	Material	Material	Materiale	Matériel		Terminals	Cables Terminales	Terminali	Bornes
	Treat up	Para tratar hasta	Trattare fino a	Pour traiter jusqu'à		Pins	Pins	Pin	Pines
	Flow Speed	Flujo Velocidad	Flow	Vitesse du débit		Gasket	Junta	Guarnizione	Joint
	Screw	Tornillo	Vite	Vis		Bearing	Cojinete	Cuscinetto	Roulement
	Screw space	Distancia entre tornillos	Distanza tra le viti	Entraxe		Tooth	Dientes	Denti	Dents
	Tube Cable	Cable Tubo Manguera	Tubo Cavo	Tuyau Durite Câble		Spline	Estrías	Scanalatura	Dents
	Thread	Rosca	Filo	Filetage		Solenoid Relay	Solenide Relé	Relé	Relais
	Boat length	Eslora	Lunghezza imbarcazione	Longueur embarcation		Wire	Cable	Cavi	Faisceau
	Control	Mando	Comando	Boitier		Drill	Taladro	Trapano	Perceuse
	Propeller	Hélice	Elica	Hélice		PROHIBITED. Not recommended.	PROHIBIDO. No recomendado.	VIETATO. Non è raccomandato.	INTERDIT. Déconseillé.
	Motor	Motor	Motore	Moteur		+ Information on page X of YAMAHA	+ Información en página X de YAMAHA	+ Informazioni alla pagina X di YAMAHA	+ Informations à la page X du YAMAHA
	4 Strokes engine	Motores 4 tiempos	Motore 4 tempi	Moteur 4 temps		+ options on page X of INSTALLATIONS SOLUTIONS	+ opciones en página X de INSTALLATIONS SOLUTIONS	+ opzioni nella pagina X di INSTALLATIONS SOLUTIONS	+ options sur la page X de INSTALLATIONS SOLUTIONS
	2 Strokes engine	Motores 2 tiempos	Motore 2 tempi	Moteur 2 temps					
	Spare part	Recambio	Ricambio	Pièce de remplacement					

## IMPORTANT

THE PRODUCTS THAT APPEAR IN OUR CATALOGS ARE VALID AND COMPATIBLE WITH THE MOTORS AND TRANSMISSIONS OF THE ORIGINAL BRANDS THAT APPEAR IN EACH SECTION. IN SOME CASES WE ALSO SUPPLIED ORIGINAL SPARE PARTS. THIS INFORMATION APPEARS WITH THE REFERENCE AT THE TIME OF CONFIRMING THE ORDER BY OUR WEB. IMAGES CONTAINED HERE MAY NOT CORRESPOND WITH TOTAL ACCURACY TO THE PRODUCT SUPPLIED. RECAMBIOS MARINOS, S.L.U. RESERVES THE RIGHT TO CANCEL OR CHANGE PRODUCTS WITHOUT PRIOR NOTICE.

## IMPORTANTE

LOS PRODUCTOS QUE APARECEN EN NUESTROS CATALOGOS SON VÁLIDOS Y COMPATIBLES CON LOS MOTORES Y TRANSMISIONES DE LAS MARCAS ORIGINALES QUE APARECEN EN CADA SECCIÓN. EN ALGUNOS CASOS, TAMBIÉN SUMINISTRAMOS RECAMBIOS ORIGINALES. ESTA INFORMACIÓN APARECE CON LA REFERENCIA EN EL MOMENTO DE CONFIRMAR EL PEDIDO POR NUESTRA WEB. LA IMÁGENES AQUÍ CONTENIDAS PUEDEN NO CORRESPONDER CON TOTAL PRECISIÓN AL PRODUCTO SUMINISTRADO. RECAMBIOS MARINOS, S.L.U. SE RESERVA EL DERECHO DE ANULAR O CAMBIAR PRODUCTOS SIN PREVIO AVISO.

## IMPORTANTE

I PRODOTTI CHE COMPAIONO NEI NOSTRI CATALOGHI SONO VALIDI E COMPATIBILI CON I MOTORI E LE TRASMISSIONI DEI MARCHI ORIGINALI CHE APPAIONO IN OGNI SEZIONE. IN ALCUNI CASI ABBIAMO FORNITO ANCHE RICAMBI ORIGINALI. QUESTA INFORMAZIONE RISULTA CON IL RIFERIMENTO AL MOMENTO DELLA CONFERMA DELL'ORDINE DA PARTE DEL NOSTRO WEB. LE IMMAGINI QUI CONTENUTE POTREBBERO NON CORRISPONDERE ESATTAMENTE AL PRODOTTO FORNITO. RECAMBIO MARINOS, S.L.U., SI RISERVA IL DIRITTO DI CANCELLARE O MODIFICARE I PRODOTTI SENZA PREAVVISO.

## IMPORTANT

LES PRODUITS QUI FIGURENT DANS NOS CATALOGUES SONT VALIDES ET COMPATIBLES AVEC LES MOTEURS ET LES TRANSMISSIONS DES MARQUES ORIGINALES QUI SONT PRESENTES DANS CHAQUE SECTION. DANS CERTAINS CAS NOUS FOURNISSONS EGALEMENT DES PIÈCES DE RECHANGE ORIGINALES. CETTE INFORMATION EST MENTIONNÉE AVEC LA RÉFÉRENCE SUR NOTRE SITE WEB. LES IMAGES CONTENUES DANS CE DOCUMENT PEUVENT NE PAS CORRESPONDRE AVEC UNE PRÉCISION TOTALE AU PRODUIT FOURNI. RECAMBIO MARINOS, S.L.U. SE RÉSERVE LE DROIT D'ANNULER OU DE MODIFIER DES PRODUITS SANS PRÉAVIS.



## INSTALLATION, MAINTENANCE AND REPAIR

1	WORK STANDS	4
2	TOOLS	8
3	LUBRICANTS RECLUBE	18
4	LUBRICANT & GREASE	21
5	OIL AND GREASE TOOLS	24
6	MAINTENANCE	27
7	PAINTS	31
8	PERMATEX	33
9	LOCTITE	36
10	STEERING SYSTEM	38
11	CONTROL CABLES	44
12	UNIVERSAL CONTROLS AND ACCESSORIES	46
13	STEERING WHEELS	50
14	INSTALLATION ACCESSORIES	52
15	HYDROFOIL STABILIZER AND SECURITY	53

## FUEL & FILTRATION SYSTEM

1	FUEL PUMP	59
2	FUEL HOSE	60
3	FUEL TANK COMPONENTS & CONNECTORS	60
4	FUEL FILTERS AND ELEMENTS	61

## ELECTRIC SYSTEM

1	FUSES	66
2	IGNITION KILL SWITCHES	67
3	IGNITION STARTER SWITCHES WITH RETURN	67
4	SENSORES Y ALARMAS	68



## INSTALACIÓN, MANTENIMIENTO Y REPARACIÓN

1	SOPORTES DE TRABAJO	4
2	HERRAMIENTAS	8
3	LUBRICANTES RECLUBE	18
4	LUBRICANTES Y GRASA	21
5	HERRAMIENTAS PARA GRASA Y ACEITE	24
6	MANTENIMIENTO	27
7	PINTURAS	31
8	PERMATEX	33
9	LOCTITE	36
10	SISTEMA DE GOBIERNO	38
11	CABLES DE MANDO	44
12	MANDOS UNIVERSALES Y ACCESORIOS	46
13	VOLANTES	50
14	ACCESORIOS DE INSTALACIÓN	52
15	ESTABILIZADORES, ELEVADORES Y SEGURIDAD	53

## SISTEMA DE ALIMENTACIÓN Y FILTRACIÓN

1	BOMBA DE COMBUSTIBLE	59
2	MANGUERA CARBURANTE	60
3	COMPONENTES TANQUE Y CONECTORES	60
4	FILTROS DE COMBUSTIBLE Y ELEMENTOS	61

## SISTEMA ELÉCTRICO

1	FUSIBLE	66
2	DESCONECTADOR DE SEGURIDAD	67
3	LLAVE DE ARRANQUE CON RETROCESO	67
4	SENDERS & ALARMS	68



## INSTALLAZIONE, MANUTENZIONE E RIPARAZIONE

1	SUPPORTI DI LAVORO	4
2	ATTREZZI	8
3	LUBRIFICANTE RECLUBE	18
4	LUBRIFICANTE E GRASSO	21
5	ATTREZZI PER OLIO E GRASSO	24
6	MANUTENZIONE	27
7	PITTURE	31
8	PERMATEX	33
9	LOCTITE	36
10	SISTEMA DI TIMONERIA	38
11	CAVI COMANDO	44
12	CONTROLLI UNIVERSALI E ACCESSORI	46
13	VOLANTI	50
14	ACCESSORI DIREZIONE	52
15	STABILIZZATORI, ASCENSORI E SICUREZZA	53

## SISTEMA DI ALIMENTAZIONE E FILTRAZIONE

1	POMPA BENZINA	59
2	TUBO DI CARBURANTE	60
3	COMPONENTI SERBATOIO E CONNETTORI	60
4	FILTRI BENZINA E RACCORDI	61

## SISTEMA ELETTRICO

1	FUSIBILE	66
2	INTERRUTTORE DI STOP	67
3	CHIAVE DI AVVIAMENTO CON RITORNO	67
4	SENSORI E ALLARMI	68



## INSTALLATION, MAINTENANCE ET REPARATION

1	SUPPORTS DE TRAVAIL	4
2	UTILS	8
3	LUBRIFIANTS RECLUBE	18
4	LUBRIFIANT ET GRAISSE	21
5	OUTILS POUR L'HUILE ET LA GRAISSE	24
6	MAINTENANCE	27
7	PEINTURES	31
8	PERMATEX	33
9	LOCTITE	36
10	SYSTÈME DIRECTION	38
11	CÂBLES DE COMMANDE	44
12	COMMANDES UNIVERSELLES ET ACCESSOIRES	46
13	VOLANTS	50
14	ACCESSOIRES D'INSTALLATION	52
15	STABILISATEURS, POWER TRIM-LIFT ET SÉCURITÉ	53

## SYSTÈME D'ALIMENTATION ET DE FILTRATION

1	POIRE À CARBURANT	59
2	TUYAU DU CARBURANT	60
3	COMPOSANTS ET CONNECTEURS DU RÉSERVOIR	60
4	FILTRE A ESSENCE ET CARTOUCHE DE RECHANGE	61

## SYSTÈME ÉLECTRIQUE

1	FUSIBLE	66
2	INTERRUPTEUR DE SÉCURITÉ	67
3	CONTACTEUR À CLÉ AVEC RETOUR	67
4	SONDES ET ALARMES	68



# Installation, maintenance and repair

INSTALLATION,  
MAINTENANCE AND  
REPAIR

INSTALACIÓN,  
MANTENIMIENTO Y  
REPARACIÓN

INSTALLAZIONE,  
MANUTENZIONE E  
RIPARAZIONE

INSTALLATION,  
MAINTENANCE ET  
REPARATION

1

## WORK STANDS

## SOPORTES DE TRABAJO

## SUPPORTI DI LAVORO

## SUPPORTS DE TRAVAIL

### MEGASUPPORT

- Quick width-to-height adjustment with bolt system.
- Specially designed pads limit pitching movement (side to side) making it easier to position the boat during positioning.
- Can be adjusted to independent heights to display the boat at an incline.
- Polyurethane wheels for almost any flat surface, including tile and marble.

### MEGASOPORTE PARA EMBARCACIONES

- Ajuste rápido ancho/alto con sistema de bulón.
- Las almohadillas limitan el movimiento de cabeceo (lado a lado) durante la colocación del barco.
- Se puede ajustar a alturas independientes para exhibir el barco inclinado.
- Ruedas de poliuretano para casi todo tipo de superficies planas, incluidas baldosas y mármol.

### MEGASUPPORTO PER LE IMBARCAZIONE

- Regolazione rapida da larghezza ad altezza con sistema a bulloni.
- I cuscinetti appositamente progettati limitano il movimento di beccheggio (da un lato all'altro) facilitando il posizionamento dell'imbarcazione.
- Può essere regolato ad altezze indipendenti per visualizzare l'imbarcazione in pendenza.
- Ruote in poliuretano per quasi tutte le superfici piane, comprese piastrelle e marmo.

### MÉGASUPPORT POUR LES BATEAUX

- Réglage rapide de la largeur à la hauteur grâce au système de boulons.
- Des patins spécialement conçus limitent le mouvement de tangage (d'un côté à l'autre), ce qui facilite le positionnement du bateau lors de la mise en place.
- Peut être réglé à des hauteurs indépendantes pour afficher le bateau en inclinaison.
- Roues en polyuréthane pour presque toutes les surfaces planes, y compris le carrelage et le marbre.

REF			
RECMJ10PS	165,1 --> 246,4 cm	60,9 --> 82,5 cm	4,5 T

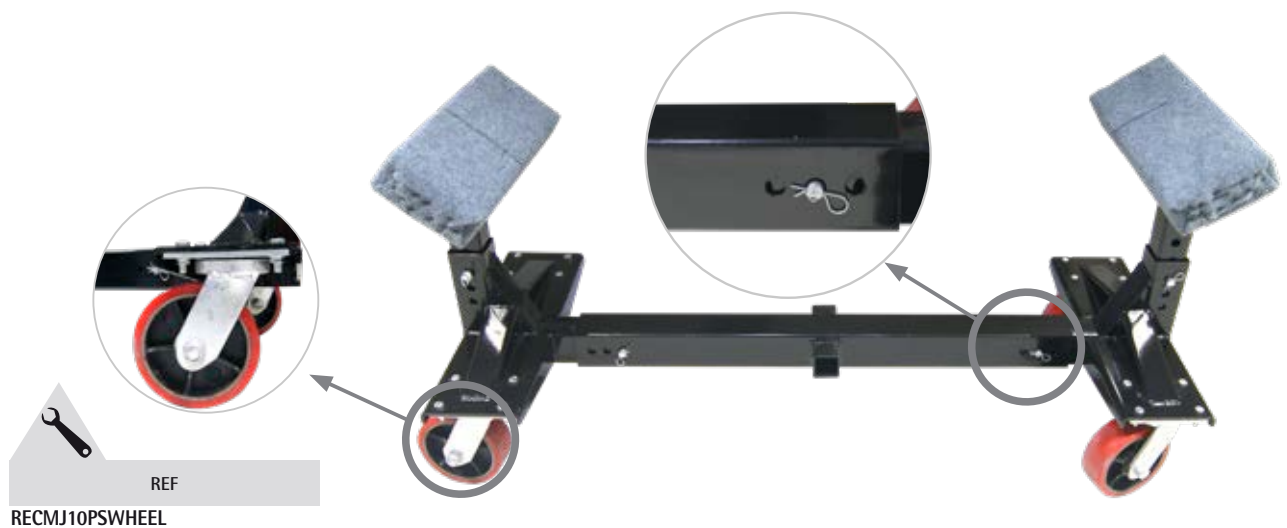

REF  
RECMJ10PSWHEEL

**BOAT STANDS**

REF	
RECED36	1.500 kg

	REF
RECED36C	

**SOPORTES PARA EMBARCACIONES**

**SUPPORTI PER IMBARCAZIONI**

**BERS ROULANT POUR BATEAU**



**STANDS**

**BOAT HANDLING JACKS & STANDS**

- Work station for bottom repair & cleaning.
- Trailer rolls in out past jacks, allowing you to take boats on or off trailers easily.
- Jacks have an auto lock allowing boats to be left on indefinitely.
- Can be used on dirt, gravel, black top or cement.
- Can be used anywhere! Shop, yard, showroom.

**SOPORTES**

**SOPORTES DESCARGA DE EMBARCACIONES**

- Para cargar o descargar embarcaciones de los remolques o cuna.
- Los remolques pueden entrar y salir entre los gatos hidráulicos libremente.
- Su recorrido de elevación es de 51 cm.
- Equipado con válvula de bloqueo que permite mantener el barco indefinidamente en la posición deseada.
- Puede actuar sobre tierra, grava, asfalto o cemento, tanto en la tienda, como en el varadero o exposición.

**SUPPORTO**

**SUPPORTI SCARICO IMBARCAZIONI**

- Per caricare o scaricare imbarcazioni da rimorchi o sostegni.
- I rimorchi possono entrare e uscire tra i crik idraulici liberamente.
- Escursione max di 51 cm.
- Fornito di valvola di blocco che permette di mantenere la barca nella posizione desiderata per diversi tempi.
- Può essere usato su terra, ghiaia, asfalto o cemento, come in negozio o in esposizione.

**SUPPORTS**

**SUPPORTS DE DÉCHARGE DE BATEAU**

- Pour charger ou décharger des bateaux de remorques ou de berceaux.
- Les remorques peuvent entrer et sortir librement entre les vérins hydrauliques.
- Sa course d'élevation est de 51 cm.
- Equipé d'une valve de blocage qui permet au navire d'être maintenu indéfiniment dans la position souhaitée.
- Il peut agir sur terre, gravier, asphalte ou ciment, aussi bien en magasin qu'en hangar à bateaux ou en exposition.

REF KIT	INCLUDED	INCLUYE	INCLOSO	COMPREND	
RECH10	Jacks	Soportes hidráulicos	Supporti idraulici	Supports hydrauliques	x4
	REC12 Straight arms	Soportes	Supporti	Supports	x4
	REC15 10" drop arms	Soportes inclinados 25 cm	Supporti inclinati 25 cm	Supports inclinés de 25 cm	x4
	REC20 4"x18" contact pads	Soportes asiento barco	Supporti appoggi barche	Supports de siège de bateau	x4
RECH10-1/4	Jack	Soporte hidráulico	Supporto idraulico	Support hydraulique	x1 40,000 lbs 18 tn
	REC12 Straight arm	Soporte	Supporto	Support	x1
	REC15 10" drop arms	Soporte inclinados 25 cm	Supporto inclinato 25 cm	Support incliné de 25 cm	x1
	REC20 4"x18" contact pad	Soporte asiento barco	Supporto appoggio barche	Support de siège de bateau	x1



REF	INCLUDED	INCLUYE	INCLOSO	COMPREND		
1 REC12	Straigh support standard	Soporte plano std.	Braccia piatto standard	Support plat standard	900 kg 1.800 kg 3.000 kg 3.600 kg	83,8 - 132 cm
	1st pin hole	1ª posición	1ª posizione	1ère position		
	2nd pin hole	2ª posición	2ª posizione	2ème position		
	3rd pin hole	3ª posición	3ª posizione	3ème position		
	4th pin hole	4ª posición	4ª posizione	4ème position		
2 REC15 REC16	Drop arm	Soporte inclinado	Braccia	Support incliné		28 cm = 10"
						51 cm = 20"
3 REC17						12,5 cm = 5"
4 REC18	Single riser extension	Suplemento	Suplementi	Supplement		25 cm = 10"
5 REC19 REC20	Large pad	Soporte con goma	Braccia contatto	Support	6.800 kg + - 6.800 kg	76 cm = 30"



	REF
6 RECNSCYL	Piston Pistón Pistone Vérin
7 RECKFW	Hydraulic jack FT-Wheel Rueda hidráulica Ruota idraulica Roue



STANDS FOR STERN DRIVES

SOPORTES PARA COLAS

SUPPORTI PER PIEDI

SUPPORTS D'EMBASES



REF  
  
 RECSR9 9

REF  
  
 RECSR9WHEEL

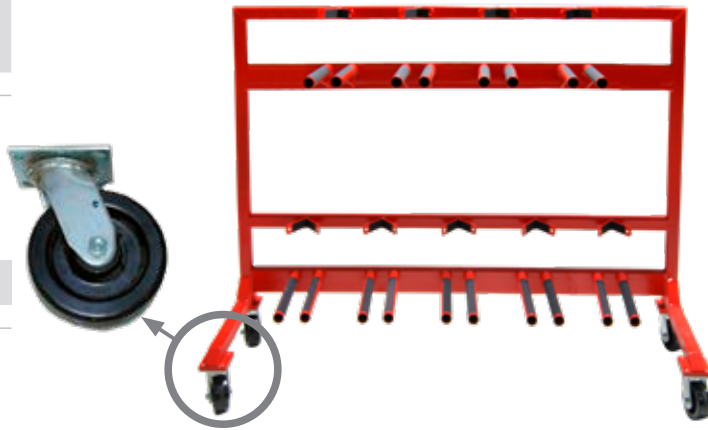

- Stern drive installer.
- Especially helpful on boats with integrated swim platforms.
- Built with extra long clamping arms and wheel base, plus heavyduty lifting capacity for those extra heavy drives.
- Also works great on dual prop drives.
- 4 air tires allow for rugged yard use.

- Carro con gato hidráulico para la instalación de colas.
- Especialmente útil en embarcaciones con plataforma integrada.
- Brazos extra largos de sujeción y base con 4 ruedas neumáticas.
- Para colas de peso extra y de doble hélice.

- Carro con crik idraulico per l'installazione di piedi.
- Specialmente utile nelle imbarcazioni con piattaforma integrata.
- Larghi bracci di fissaggio e una base con 4 ruote pneumatiche.
- Per piedi con peso extra e con doppia elica.

- Chariot avec vérin hydraulique pour l'installation d'embase.
- Particulièrement utile dans les bateaux avec plate-forme intégrée.
- Bras de support extra longs et une base avec 4 roues pneumatiques.
- Pour des embases de poids important et en double hélice.

REF  
 RECJO6HD

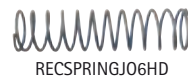

REF

RECKOCYL	Piston	Pistón	Pistone	Vérin
RECKRW	Hydraulic jack RE-Wheel	Rueda completa	Ruota completa	Roue complète
RECKFW	Hydraulic jack FT-Wheel	Rueda hidráulica	Ruota idraulica	Roue
RECJO10	Suplement 10"	Suplemento 25 cm	Supplemento 25 cm	Supplément de 25 cm
RECHANDLEJO6HD	Handle	Maneta	Maniglia	Poignée
RECSRINGJO6HD	Spring	Muelle	Molla	Ressort

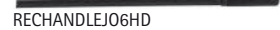

- Holds all kind of drives and outboard engines.

- Soporte trabajo reparación todo tipo de colas y motores fueraborda.

- Supporto lavoro per riparare tutti i tipi di piedi e motori fuoribordo.

- Support pour les travaux de réparation de tous types d'embase et moteurs hors-bord.

REF  
 RECWS3



**STANDS FOR ENGINES**

- Allow engine to be rotated 360°.
- Adjustable mounting plate will accommodate all engine types, GM, FORD, VOLVO.
- Foldable

REF	
1 RECTOOL1	500 kg
2 RECTOOL1GB	680 kg

**RECMAR®**



**SOPORTES PARA MOTORES**

- Soporte de trabajo giratorio 360° con ruedas para todo tipo de motores GM, FORD, VOLVO.
- Plegable.



**SUPPORTI PER MOTORI**

- Carrello supporto motore, permette il movimento per 360° utile per lavorazioni in coppa.
- Fornito di ruote piene, può montare tutti i blocchi GM, FORD, VOLVO.
- Pieghevole



REF	
YARES2	GM, FORD, VOLVO
YARCHA	Kit GM







YARCHA



YARES2

**OUTBOARD MOTOR CARRIER**

- Manufactured in galvanized steel pipe and wooden board.
- With tank holder and fixing strap.





Ref					
1 GS73122	12 kg	50 kg	90 cm	Ø 15 cm	43 cm
2 GS73119	12 kg	80 kg	95 cm	Ø 36 cm	45 cm

**GOLDENSHIP**



**OUTBOARD STAND**

- Foldable.
- Manufactured in galvanized steel pipe and wooden board.

Ref				
GS73120	6 kg	40 kg	90 cm	43 cm

**GOLDENSHIP**



**CARROS PORTAMOTOR**

- Con soporte para depósito de combustible y sandow de fijación.
- Fabricado en acero zincado y tablero marino.

**CARRELLO PORTA MOTORE**

- Con supporto per serbatoio carburante.
- In acciaio zincato e bordo marino.

**CHARIOT MOTEUR**

- Avec support pour réservoir de carburant et fixation sandow.
- Fabriqué en acier galvanisé et planche marine.

**TOOLS**

**HERRAMIENTAS**

**ATTREZZI**

**UTILES**

**MOTOR FLUSHER**

- For use on most outboards and inboard/outboards engines with side water inlets.

**OREJERAS**

- Tomas de agua para refrigeración de motores fueraborda y colas intra-fueraborda.

**CUFFIE LAVAGGIO**

- Cuffie lavaggio per motori entro-fuoribordo e fuoribordo.

**OREILLES**

- Sorties d'eau pour le refroidissement du moteur hors-bord et in-bord.

REF	A	B
1 GS30350	265 mm	126 mm
2 GS30351 PROFESSIONAL	377 mm	138 mm
3 GS30352	285 mm	115 mm
4 GS30353 PROFESSIONAL	367 mm	162 mm

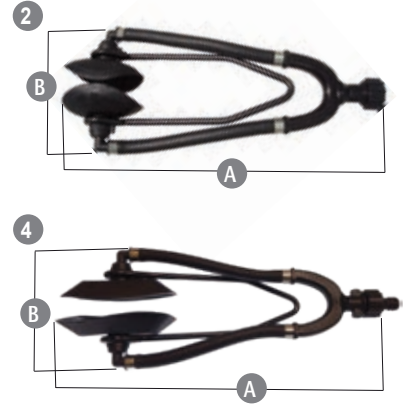
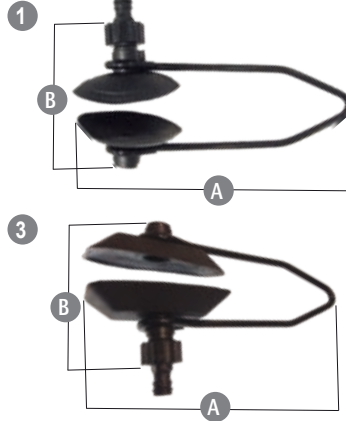

**FLEXIBLE IMPELLER REMOVAL**

REF	
GS20198	Ø 65 mm 2-1/2"
GS20199	Ø 77 - 127 mm Ø 3" - 5"



**EXTRACTOR IMPULSORES FLEXIBLES**

**ESTRATTORE GIRANTE FLESSIBILE**

**EXTRACTEUR DE TURBINE FLEXIBLES**



**PROP AND BEARING PULLER**

REF	
REC90095	



**EXTRACTOR COJINETES Y HÉLICES**



For prop and old style bearing carrier.  
Para hélices y cojinetes antiguos.  
Per eliche e cuscinetti vecchi.  
Pour hélices et roulements anciens

**ESTRATTORE CUSCINETTI E ELICHE**



For new style bearing carrier.  
Para cojinetes modernos.  
Per cuscinetti moderni.  
Pour roulements modernes

**EXTRACTEUR DE ROULEMENT ET D'HELICE**



**UNIVERSAL PULLER PLATE**

REF		
REC91-00001	30-50 mm	1 1/4" - 2 1/4"
REC91-00002	50-75 mm	2 1/4" - 3 1/2"
REC91-37241	75-105 mm	3" - 4 1/2"



**EXTRACTOR PIÑONES Y COJINETES**



**ESTRATTORE PIGNONE E CUSCINETTI**

**EXTRACTEUR DE PIGNON ET PALIER**



**FLYWHEEL HOLDER PER OUTBOARDS**

REF	
REC5515100	



**LLAVE FRENO VOLANTE PARA FUERABORDAS**

**CHIAVE FRENO VOLANTE PER FUORIBORDO**

**CLÉ FREIN DE VOLANT POUR HORS-BORD**





**ENGINE CYLINDER HONE**

REF  
CRA904633

REF  
CRA946331



**OIL FILTER WRENCH**

REF

1 REC70720 65-110 mm  
2 RECRK22628

**RECMAR®**



**PROP WRENCH KIT**

REF

1 REC91-859046Q3  
2 REC91-859046Q4

**RECMAR®**

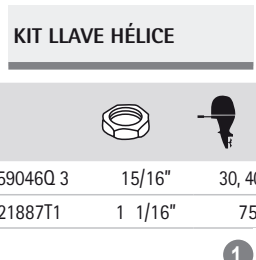

**PULLER TOOL KIT**

REF  
SSP4600

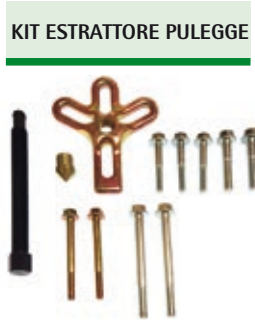

- Harmonic ballancer puller and installation tool kit.  
- Heavy duty tool.  
- Can also be used for steering wheels and pulleys

- Kit para extraer e instalar poleas.  
- También puede utilizarse para volantes de dirección y poleas en general.

- Kit per estrarre e installare pulegge.  
- Si può utilizzare per volani di direzione e pulegge in generale.

- Kit pour extraire et installer les poulies.  
- Il peut également être utilisé pour les volants et les poulies en général.

REF

SSPHBP100K

FORD  
GM  
CHRYSLER

max  
KG

20 kg



**RING COMPRESOR KIT**

REF

SSP4213 6 (2-7/8" - 4-3/8")  
6 (7- 11 cm)



**KIT FASCE-PISTONI**

REF

SSP4206 127 mm Ø / 2-1/8" - 5" Ø  
SSP4207 178 mm Ø / 3-1/2" - 7" Ø



**TRIM PLUGS EXTRACTOR**

**EXTRACTOR TAPONES DE TRIM**

**ESTRATTORE PER TAPPI DI TRIM**

**EXTRACTEUR DE BOUCHON DE TRIM**

REF	RECTOOLTRIMKIT	RECTOOLTRIMKIT2
RECTOOLTRIM1	1/2" + RECPIN4 + RECPIN4.5	38 mm
RECTOOLTRIM2	1/2" + RECPIN4 + RECPIN4.5	32 mm
RECTOOLTRIM3	1/2" + RECPIN6	35 mm
RECTOOLTRIM4	1/2" RECPIN4.5	47mm
RECTOOLTRIM5	1/2" RECPIN6	40mm
RECTOOLTRIM6	1/2" RECPIN6	42mm
RECTOOLTRIM7	1/2" RECPIN6	46mm
RECTOOLTRIM8	1/2" RECPIN5	31mm



SPARE KITS  
Replacement pins are not guaranteed.

KITS DE RECAMBIO  
Los pines de repuesto no tienen garantía.

KIT DI RICAMBIO  
I perni di ricambio non sono garantiti.

KITS DE RECHANGE  
Les broches de remplacement ne sont pas garanties.

REF	RECTOOLTRIM1	RECTOOLTRIM2
RECPIN4	3 x 4 mm	RECTOOLTRIM1 RECTOOLTRIM2
RECPIN4.5	3 x 4.5 mm	RECTOOLTRIM1 RECTOOLTRIM2 RECTOOLTRIM4

REF	RECTOOLTRIM1	RECTOOLTRIM2	RECTOOLTRIM3	RECTOOLTRIM4	RECTOOLTRIM5	RECTOOLTRIM6	RECTOOLTRIM7	RECTOOLTRIM8
RECPIN5	3 x 5 mm	RECTOOLTRIM1	RECTOOLTRIM3	RECTOOLTRIM5	RECTOOLTRIM6	RECTOOLTRIM7	RECTOOLTRIM8	
RECPIN6	3 x 6 mm	RECTOOLTRIM1	RECTOOLTRIM2	RECTOOLTRIM3	RECTOOLTRIM4	RECTOOLTRIM5	RECTOOLTRIM6	RECTOOLTRIM7



TRIM	TILT		
RECTOOLTRIM1	Yamaha	F25 - F40	
RECTOOLTRIM1	Yamaha	F50 - F70	2016-18
RECTOOLTRIM2	RECTOOLTRIM3	Yamaha	F115
RECTOOLTRIM4	Yamaha	F40-F130 Single Cylinder	2000-14
RECTOOLTRIM2	RECTOOLTRIM3	Yamaha	F150
RECTOOLTRIM2	RECTOOLTRIM1	Yamaha	F150
RECTOOLTRIM2	RECTOOLTRIM3	Yamaha	F175 - F200 (2.8L) L4
RECTOOLTRIM1	RECTOOLTRIM1	Yamaha	F200 - F250 (3.3L) V6
RECTOOLTRIM1	RECTOOLTRIM1	Yamaha	F225 - F300 (4.2L) V6
RECTOOLTRIM2	RECTOOLTRIM3	Yamaha	F350 (5.3L) V8
RECTOOLTRIM2	RECTOOLTRIM1	Yamaha	55-90 (2-Stroke)
RECTOOLTRIM2	RECTOOLTRIM1	Yamaha	115-200 (2-Stroke)
RECTOOLTRIM2	RECTOOLTRIM3	Yamaha	115-200 + VMAX
RECTOOLTRIM1	RECTOOLTRIM1	Yamaha	225 Et + (2-Stroke) Non VMAX
RECTOOLTRIM2	RECTOOLTRIM3	Suzuki	DF115 - DF300 L4 Et V6
RECTOOLTRIM2	RECTOOLTRIM3	Evinrude	E125-E225 E-Series (2-Stroke)
RECTOOLTRIM2	RECTOOLTRIM3	Evinrude	130 - 300 ETEC
RECTOOLTRIM3	Johnson Evinrude	25 - 50 (2 Strokes)	1994-04
RECTOOLTRIM2	RECTOOLTRIM3	Johnson Evinrude	60 - 250 (2 Strokes)
RECTOOLTRIM2	RECTOOLTRIM3	Johnson Evinrude	J115-J250 J-Series
RECTOOLTRIM2	RECTOOLTRIM3	Honda	75 - 225
RECTOOLTRIM5	Mercury	Verado 175-350	
RECTOOLTRIM6	Mercury	40-115	
RECTOOLTRIM7	Mercury	135-150 (4-Stroke)	
RECTOOLTRIM8	Mercury	Optimax (3 Cyl)	
RECTOOLTRIM1	Seastar Steering		
REC19876	Volvo Penta		
RECTOOLTRIM1	Mer cruiser Alpha I Et Bravo		



**RETAINING RING WRENCH**

**HERRAMIENTA TUERCA DIABOLO**

**ATTREZO DADO DIABOLO**

**OUTIL ÉCROU DIABOLO**

REF	PART NUMBER	YAMAHA RING	MERCURY RING	SUZUKI RING	HONDA RING	TOOTH NUMBER	Ø (mm)
RECTOOL3	697-45384-02	11-87763/9			41109-ZV5-000	12	69
RECTOOL4	61B-45384-00					12	87
RECTOOL5	688-45384-02					12	87
RECTOOL2	RECTOOL6	6G5-45384-20/02	8M0168885	56122-93L00		12	94
		65N-45384-00	8M02011027			16	109
			79448			12	104
			54163			4	61
			8M0001491			12	99
			8M0111653			12	99
			8M0162798			12	83
		6AW-45384-00				12	104
		664-45384-00				4	61
		6CB-45384-00				12	99
			8661122	56122-87E00		12	83



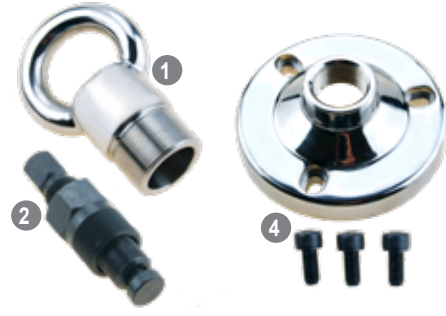

FLYWHEEL PULLER		HERRAMIENTAS VOLANTE MOTOR	ESTRATTORE VOLANO	EXTRACTEUR DE VOLANT
				
1	Universal lift adapter for motors	Adaptador universal de elevacion para motores	Adattatore di sollevamento universale per motori	Adaptateur de levage universel pour moteurs
2	Flywheel puller	Extractor de volante	Estrattore volano	Extracteur de volant
3	Fits directly on Yamaha and Mercury flywheels that do not contain integrated lift rings.	Se adapta directamente en volantes Yamaha y Mercury que no contienen anillos de elevación integrados.	Si adatta direttamente ai volani Yamaha e Mercury che non contengono anelli di sollevamento integrati.	S'adapte directement sur les volants d'inertie Yamaha et Mercury qui ne contiennent pas d'anneaux de levage intégrés.
4	(Supplied with screws)	(Se suministra con tornillos)	(Fornito con viti)	(Fourni avec des vis)
REF	OEM		REF	OEM
REC90890-06820	90890-06820 91-83164M	40, 45, 50, 60HP (4 CYL) 75, 90, 115 (-1B366822)	REC91-895343T02	91-895343T02 91-895343T01
				
			75-115HP (1B366823+) VERADO 135 - 300HP 150EFI	

**RECMAR®**



TORQUE WRENCH		LLAVE DINAMOMÉTRICA	CHIAVE DINAMOMETRICA	CLÉ DYNAMOMÉTRIQUE
REF		SCALE	INCREM.	CONNEX.
CRA944595	518 x 35 x40 mm	20-150 ft.-lbs. 33.9 - 210 N.m	1 ft.-lbs Et 1,4 N.m	1/2"



TAP AND DIE SET (INCHES)	JUEGO DE MACHOS (PULGADAS)	FILIERA (POLLICI)	KIT TARAUDS ET FILIÈRES (POUCE)
REF			
CRA952343			

MECHANICAL TOOL SET (METRIC/INCHES)	JUEGO DE LLAVES (MÉTRICO/ PULGADAS)	CASSETTA ATTREZZI (METRICHE/ POLLICI)	MALETTE D'OUTILLAGE (MÉTRIQUES/POUCES)
REF			
CRA935154			



**PHONENDOSCOPE**

- Sensitive, shockproof instrument, easily locates noises in engines bearings and other moving parts.
- Includes aluminium alloy probe / needle, surgical PVC, rubber trumpet and plastic earphones.

REF

REC91-00003

**RECMAR®**

**FONENDOSCOPIO**

- Instrumento de precisión, resistente a golpes, detecta fácilmente ruidos en motores, cojinetes y otras partes móviles.
- Incluye varilla de test, trompeta y auriculares.

**FONENDOSCOPIO**

- Strumento di precisione, resistente a colpi, rileva facilmente rumori nel motore, nei cuscinetti e altre parti mobili.
- Include la tromba e gli auricolari.

**PHONENDOSCOPE**

- Instrument de précision, résistant aux chocs, détecte facilement le bruit dans les moteurs, roulements et autres pièces mobiles.
- Comprend une tige d'essai, une trompette et des écouteurs.



**SPARK GAP TESTER**

- Good for checking spark on running engine.

REF

CYL

1	REC5119766	8
2	REC004	1

**RECMAR®**

**CHISPÓMETRO**

- Se puede comprobar la chispa con el motor en funcionamiento.

**SCINTILLOMETRO**

- Si può provare la scintilla con il motore in funzione.

**CONTRÔLEUR D'ALLUMAGE**

- L'étincelle peut être vérifiée avec le moteur en marche.

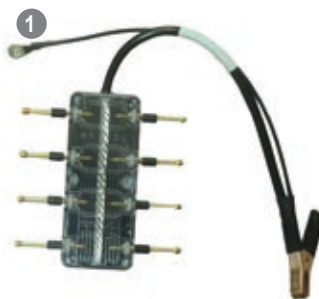

**PRESSURE / VACUUM TESTER**

- Combination unit that does pressure and vacuum testing in one units.
- Recommended to test drives.

REF

REC55134

**RECMAR®**

**VACUÓMETRO DOBLE FUNCIÓN**

- Presión y vacío.
- Ideal para comprobar las colas.

**VACUOMETRO DOPPIA FUNZIONE**

- Pressione e sottovuoto.
- Ideale per il controllo dei piedi.

**VACUOMÈTRE DOUBLE FONCTION**

- Pression et vide.
- Idéal pour vérifier les embases.



**SPARK PLUG, EXTENSION WIRES**

REF



1	REC5119902	18 cm	4
2	REC5119903	60 cm	4

**RECMAR®**

**KIT ALARGADOR CABLE BUJÍAS**

**KIT PROLUNGA CAVI CANDELE**

**KIT EXTENSION DE FAISCEAU DE BOUGIE**



**COMPRESSION TESTER KIT**

REF

GASOLINE

CRA902171 GM FORD

**COMPRESÍMETRO**

**MANOMETRO**

**COMPRESSIOMÈTRE**



<b>TIMING LIGHT</b>	<b>PISTOLA PUESTA A PUNTO</b>	<b>PISTOLA MESSA A PUNTO</b>	<b>LAMPE STROBOSCOPIQUE</b>
---------------------	-------------------------------	------------------------------	-----------------------------

REF	ADVANCE AVAN.
CRA921023	0-60



<b>REMOTE STARTER</b>	<b>INTERRUPTOR ARRANQUE</b>	<b>INTERRUTTORE AVVIAMENTO</b>	<b>INTERRUPTEUR DE DÉMARRAGE A DISTANCE</b>
-----------------------	-----------------------------	--------------------------------	---

REF
CRA902175



<b>AMPERIC NIPPER</b>	<b>PINZA AMPERIMÉTRICA</b>	<b>PINZA AMPEROMETRICA</b>	<b>PINCE AMPÈREMÉTRIQUE</b>
-----------------------	----------------------------	----------------------------	-----------------------------

REF					
	Jaw diameter	Diámetro maxilar	Diametro max	Diamètre maxi	30 mm
	Display	Display	Display	Affichage	3 3/4 digit. Max. 3999.
	Measurements	Medidas	Corrente	Effectue des mesures	AC/DC current: 40A/400A
TEC218	Precision	Precisión	Precisione	Précision	+/- (1,9% + 5 d. --> AC) +/- (2,5% + 10 d. --> DC)
	Bandwidth	Ancho de banda	Banda larga	Bande passante	50 Hz - 500 Hz (AC)
	Resolution	Resolución	Risoluzione	Résolution	AC / DC 10mA. 100mV
	Resistance	Resistencia	Resistenza	Résistance	400 Ohms



<b>MULTIFUNCTION INFRARED THERMOMETER</b>	<b>TERMÓMETRO INFRARROJOS MULTIFUNCIÓN</b>	<b>TERMOMETRO A INFRARROSSI MULTIFUNZIONALE</b>	<b>THERMOMÈTRE INFRAROUGES MULTIFONCTIONNEL</b>
---	--	---	---

REF					
	Fixed emissivity: 0.95 range	Emisividad fija: 0,95 Rango	Misurazione: 0,95 Rango	Measure fixe: 0,95 Plage	- 20 - +320 °C
	Reading in Celsius and Fahrenheit.	Lectura en grados centígrados y fahrenheit.	Lettura in gradi centigradi e fahrenheit.	Lecture en degrés Celsius et fahrenheit.	
TECDT8580	Precision	Precisión	Precisione	Précision	+/-2% (1°C)
	Distancia optimal measurement	Distancia óptima de medida	Distanza ottimale di misurazione	Distance de mesure optimale	6 - 60 cm.
	Retention of the last reading.	Retención de la última lectura	Memoria dell'ultima lettura.	Conservation de la dernière lecture	
	Auto Off function	Autoapagado	Autospegnimento	Arrêt automatique	



DIGITAL MULTITESTER	MULTITESTER DIGITAL	MULTITESTER DIGITALE	MULTIMÈTRE DIGITAL
---------------------	---------------------	----------------------	--------------------

REF				
TEC145	9V (6F22*1)	340 g	190x80x33 mm	not include no incluidas

		RANGE	BEST ACCURACY
Display Count			1999
Manual Range			✓
Data Hold			✓
Diode measurement			✓
Transistor measurement			✓
Auto Power OFF			✓
Continuity Buzzer			✓
Mechanical protection			✓
Standard Accessories	Test lead		Temperature Probe



OPTICAL TACHOMETER	TACÓMETRO ÓPTICO	TACOMETRO OTTICO	TACHYMÈTRE OPTIQUE
--------------------	------------------	------------------	--------------------

- Professional portable microprocessor-controlled and with time base of quartz crystal of high precision.
- Retention of the latest reading on screen reading and record the maximum and minimum measurement period.
- Profesional portátil controlado por microprocesador y con base de tiempos de cristal de cuarzo de gran precisión.
- Retención de la última lectura en pantalla y registro lectura máxima y mínima del periodo de medida.
- Professionale portatile controllata da un microprocessore e con display a cristalli di quarzo di alta precisione.
- Memoria dell'ultima lettura nello schermo e registro lettura massima e minima del periodo di misurazione.
- Portable professionnel contrôlé par microprocesseur et avec base de temps de cristal de quartz de haute précision.
- Conservation de la dernière lecture sur l'écran de lecture et enregistrement de la période de mesure maximale et minimale.

REF					
	RPM meter up	Medidor de RPM hasta	Misura RPM fino	Compteur de tours jusqu'à	(-99.999)
	Precision	Precisión	Precisione	Précision	+/- (0,05% + 1 d.)
TEC384	Resolution	Resolución	Risoluzione	Résolution	0,1 (-9.999,9)
	Distancia optimal measurement	Distancia óptima de medida	Distanza ottimale di misurazione	Distance de mesure optimale	50 --> 150 mm.
	-depending on ambient ligh	-en función de luz ambiente	- con luce ambiente	-selon la lumière ambiante	-300 mm
TEC786	REFLECTIVE TAPE	CINTA REFLECTANTE	BANDA PER TACOMETRO	RUBAN RÉFLECTEUR	



DIAGNOSIS TABLET

TABLET DE DIAGNOSIS

TABLET DIAGNOSI

TABLETTE DE DIAGNOSTIC



RECAXONEVOICESCREEN

13.3" (2560x1600 px) Gorilla® Glass  
 Intel® i5  
 RAM: 16 GB LPDDR4 dual channel 3200 Mhz  
 SSD 512 GB  
 WIFI double channel  
 Bluetooth® 5.1  
 Camera x 8 Megapixels  
 Militar normative MIL-STD 810G (transit drop test)  
 Windows 10 Enterprise

RECAXONENEMO

11.6" (1920x1080 px)  
 Intel® N100  
 RAM: 16 GB DDR5  
 SSD 250 GB  
 WIFI double channel  
 Bluetooth® 5.3  
 Camera x 2 Megapixels  
 Militar normative MIL-STD 810G (transit drop test)  
 Windows™ 11 IoT Enterprise  
 Trusted Platform Mobile 2.0

RECD168X0

10.1" (1920x1200 px)  
 Intel® N100  
 RAM: 8 GB DDR5  
 eMMC 250 GB  
 WIFI: 6  
 Bluetooth® 5.2  
 Camera: 2 + 5 Megapixels  
 Windows™ 11 IoT Enterprise

NAVIGATOR TXB2

- The characteristics of the hardware make it compatible with all currently existing protocols, its integrated 16-pole CPC connector, allows the use of all diagnostic cables. It is compatible with AXONE and PC.
- Thanks to Bluetooth technology, the technician can make a comfortable diagnosis without wires, even from the jetty.
- It allows the recording of the diagnosis session in "dynamic tests" mode, that is to say with the boat in motion, to locate specific faults that could not be verified in the mooring.

- Las características del hardware lo compatibilizan con todos los protocolos actualmente existentes, su conector CPC de 16 polos integrados, permite el uso de todos los cables de diagnosis. Es compatible con AXONE y PC.
- Gracias a la tecnología Bluetooth el técnico podrá realizar una cómoda diagnosis sin cables de por medio, incluso desde el pantalán.
- Permite la grabación de la sesión de diagnosis en modalidad "pruebas dinámicas", es decir con la embarcación en movimiento, para localizar averías específicas que no se podrían verificar en el amarre.

- Le caratteristiche hardware lo rendono compatibile con tutti i protocolli attualmente esistenti, il suo connettore CPC 16 poli integrato consente l'utilizzo di tutti i cavi diagnostici. E' compatibile con AXONE e PC.
- Grazie alla tecnologia Bluetooth il tecnico potrà realizzare una diagnosi senza cavi in mezzo, anche dal molo.
- Permette la registrazione di una sessione di diagnosi in modalità "prova dinamica", ovvero con l'imbarcazione in movimento, per constatare avarie specifiche che non si possono verificare in officina.

- Les caractéristiques du matériel le rendent compatible avec tous les protocoles existants, son connecteur CPC 16 pôles intégré permet l'utilisation de tous les câbles de diagnostic. Il est compatible avec Axone et PC.
- Extrêmement puissant, il permet au mécanicien de gérer facilement les fichiers des cartes.
- Il permet l'enregistrement de la séance de diagnostic en mode «test dynamique» c'est à dire avec le bateau en mouvement pour localiser des défauts spécifiques non vérifiables en atelier.

RECD117D0

SRAM 16 Mb  
 eMMC 8 GByte  
 BLUETOOTH 5.0 class 1  
 • Bink codes  
 • K, L (protection 100 mA) ISO9141-2, ISO14230  
 • FD CAN 11898-2:2016 2 channels  
 • CAN ISO 11898-3 low speed  
 • CAN SAE J2411 only wire  
 • SAE J1850 PWM / VPW  
 • SAE J1708  
 • RS232



REC3901775

KITS

	MOD	OEM	RECZ16890	RECAXONENEMOPLUS	RECAXONEVOICE	RECD06591	RECZ06590PC
	AXONE NEMO plus	D127X2		✓			
	AXONE VOICE	D171X0			✓		
	AXONE NEMO LIGHT	D192X0	✓				
	NAVIGATOR TXB2	D189D0	✓	✓	✓	✓	✓
	HP250 G9 5Y427EA						✓
	IDC5 PLUS	P16990	✓				
	IDC5 PLUS PC	P12990				✓	✓
	IDC5M PREMIUM	P13090		✓	✓		
	TEXPACK (annual licence I)	AGA00M	✓	✓	✓		

**APPLICATIONS**

See the updated list of applications in:

**APLICACIONES**

Consulte la lista actualizada de aplicaciones en:

**APPLICAZIONI**

Vedi l'elenco aggiornato delle applicazioni in:

**APPLICATIONS**

Consultez la liste mise à jour des applications sur:

<https://www.texaiberica.com/diagnostic-coverage/>

INBOARD   INTRABORDA   ENTORBORDO   IN-BORD	
CATERPILLAR	3196, 3176, 3196, 3406C, 3508B/C, 3512B/C/E, 3516B/C/E, C6.6, 7, 7.1, 8.7, 9, 9.3, 12, 12.9, 15, 18, 30, 32
CFMOTO	CF3100C/P
CRUSADER	5.0, 5.7, 6.0, 8.1
CUMMINS Marine	ISL, QSB/C/K/LM
CUMMINS MERCUISER DIESEL	QSD
DAEDONG	D4DD
DAF Marine	UPEC
FIAT FPT	CURSOR, NEF, S30
FNM	HPEP, HPE
FORD Marine	3.2
HYUNDAI SEASALL	D150P/S, 170J/P/S, S150J/P/S, 220P/S, 250J/P/S, 270J/P/S, U125J/P/S
ILMOR	5.7L, 6.0L, 6.2L, MV-8
INDMAR	5.7, 6.0, 6.2, 8.4
JOHN DEERE Marine	4045AFM85, 4045SFM85, 4045TFM85, 6068SFM85, 6068TFM85, 6068TFM75, 6090AFM85, 6090SFM85
KODIAK Marine	2.4L, 4.3L, 5.3L, 5.7L, 6.0L, 6.2L
LOMBARDINI Marine	LDW
MALIBU	LT4, M5DI, M6DI
MAN	D2840, 2842, 2848, 2862, 2868, 2876
MARINE POWER	3.0L, 4.3L, 5.0L, 5.7L, 6.0L, 6.2L, 8.1L
MERCUISER	Black, Scorpion 2.8L, 3.0, 4.2L, 4.3L, 4.5L, 5.0L, 5.7L, 6.2L, 7.4L, 8.1L, 8.2L, 100, 350, 377, 454, 496, 502
MERCURY Diesel	3.0L, 6.7 MD, QSD, TDI
MERCURY Racing Inboard	500, 520, 525, 540, 565, 575, 600, 700, 850, 860, 1075, 1100, 1350, 1550, 1650 Scorpion
MTU	2000, 4000
NANI DIESEL	T4
PANTHER AIRBOATS	6.2L
PCM Marine Engines	5.0L, 5.7L, 6.0L, 8.1L
PERKINS	1106C-E60TA 6.0L
SCANIA Marine	D109/13/16
SEA-DOO	S150, 180, 200, 205, 210, 230. Islandia, Wake, Sportster
SISU	44, 49, 66, 74, 84 M054NA33, 84K32, 94K33, 114K33, 126M28, 144M38/ V38, 156K25, 164M40, 166M28, 174V40, 196K35, 236K42/43, 256H45/K43, 256H45/K43, 286H43, 306H43WJ SE126E25/32, 144E38, 156E26/32, 164E40, 186E35, 196E35, 236E40/S36 266E40/S36, 286E40, 306J38
STEYR MOTORS	
TOYOTA MARINE	V8
VM MOTORI	2.8L, 4.2L MD704LH/LI/LS/, 706LB/LI/LX/MS/MX MR504LB/LH/LS/LX, 704LH/LS/LX, 706LB/LH/LS/LX
VOLKSWAGEN Marine	SDI, TDI
VOLVO PENTA	4.3, 5.0, 5.7, 7.4, 8.1, 8.2, D3/3-D/4/6/8/9/11/12/13/16 KAD, TAMD, V6-200/240/280/300/350/380/430
YAMAHA Marine	19FT, 22FT, 23FT, 24FT, 25FT, 27FT, SPORT, WAKE 4BY2-150/Z, 4BY2-180/Z, 4BY3-150/Z, 4BY3-180/Z, 4JH45/57/80/110, 4LV150/170/195/230/250 6BY2-220/Z, 6BY2-260/Z, 6BY3-220/Z, 6BY3-260/Z 6LY3, ETA/ETP/STA/STB/STP/UTP, 8LV-320/Z, 8LV-350/Z, 8LV-370/Z
YANMAR	

OUTBOARD   FUERABORDA   FUORIBORDO   HORS-BORD	
EVINRUDE	40, 50, 70, E-Tec, Ficht, G2
HIDEA	40, 60
HONDA Marine	BF40D/E, 50D, 60A, 75D/DK3, 80A/AK1, 90D/DK4, 100A/AK1, 115A/D, 135A/A4/AKO, 150A/A4, 175A/A4/AKO, 175A/AK3/D, 200A/AK3/D, 225A/AK3/D, 250A/D BFP60A
JOHNSON	4 Stroke, 40, 50, 60, 70, 90, 115, 140, 225
MARINER	4 Stroke, OptiMax, Verado, 3.0, 25, 30, 40, 50, 60, 75, 80, 90, 100, 115, 150, 175, 200, 225
MERCURY	4 Stroke, OptiMax, Verado, Pro, SeaPro, 3.0, 15, 20, 25, 30, 40, 50, 60, 75, 80, 90, 100, 115, 150, 175, 200, 225
MERCURY Racing	OPTIMAX, DSi, VERADO 400R, 2.5L, 3.0L, 225X, 250, 300X, 360, 450
NISSAN Marine	NSD
PARSUN	40 EFI
SELVA Marine	4 Stroke EFI, AMBERJACK, ARUANA, BEAKED, BLUE, DORADO, FIN, GREY, KILLER, MARLON, MURENA, NARWHAL, RIGHT, SEI, SPREARFISH, SWORDFISH, TARPON, WHITE
SEVEN Marine	527, 557, 577, 627
SUZUKI Marine	DF 9.9B, 15A, 20A, 25A, 30A, 40A/OH, 50A/AV/TH, 60A/AV/TH, 70A, 80A, 90A, 100A/B, 110A, 115A/B/BG/SS, 140A/B/BG, 150A/AP/SS/TG/ZG, 175A/AP/TG/ZG, 200A/AP/SS, 225, 250/AP/SS, 300/AP/B, 325A, 350A
TOHATSU	MD, MFS, BFW60, BFT60, 75, 90, 115, 150, 200, 225, 250 F20G/S, 25/C/G, 30/B, 40/D/F/G/H, 50/F/H, 60/C/F, 70A, 75/B/C/D, 80/B/C/D, 90/B/C/D, 100/D/F, 115A/B/C, 125A, 130A, 150A/B/C/CA/D/F/G, 165A, 175A/B/C/CA, 185A, 200A/B/C/CA/D/F/G, 225A/B/C/D/F/G/H, 250A/B/C/D/F/G/H/J/L, 275A, 300A/B/C/D, 350A, 375A, 425A FT50G/J, 60D/F
YAMAHA Marine	T50, 60 V, VF90A, 115A, 150, 175A, 200, 225, 250 VZ150, 175, 200, 225, 250, 300 XF375/425, ZF375/425 Z150/P/Q, 175/G/H, 200/N/P/Q/R, 225/H, 240A/B, 250/D/F, 300A/B

PWC   MOTOS DE AGUA   MOTO D'ACQUA   JET-SKI	
HONDA Marine	Aquatrax 1200N2/N3/T2/T3/T3D, 1500N3/T3
KAWASAKI Marine	STX/-12F/15F, SX-R, Ultra.
SEA-DOO	Fish, GTI, GTR, GTS, GTX/-S, RXP/-X, RXT/-X, Spark, Wake
YAMAHA Marine	Waverunner

**CABLE KIT FOR DIAGNOSIS AND KEY REPROGRAMMING**

REF   
**REC3906015** BRP Group 3151/AP43

**KIT DIAGNOSIS Y REPROGRAMACIÓN DE LLAVE**

**KIT PER LA DIAGNOSI E RIPROGRAMMAZIONE CHIAVE**

**KIT DE DIAGNOSTIC ET REPROGRAMATION DE CLÉ**



**REFERRAL POINTS (AM01, AM01CAN)**

REF   
**REC3904048** AM10

**PUNTAS DE DERIVACIÓN (AM01, AM01CAN)**

**PUNTA DI DERIVAZIONE (AM01, AM01CAN)**

**PONTS DE DÉRIVATION (AM01, AM01CAN)**



WITHOUT INTERFACE CABLE		SIN CABLES DE INTERFACE	
REF			
REC3902417	OBDD, FNM, Volkswagen, HYUNDAI	AM08	
REC3902659	FPT	AM11	
REC3904277	CUMMINS, MERCURISER Diesel, VM (not D-Tronic), KOHLER	AM24A	
REC3905159	Volvo EGC 05/05>05/07 Round connector Conector redondo Connettore rotondo Connecteur rond	AM26	
REC3905286	MTU-MDEC	AM28	

SENZA CAVI INTERFACE		SANS CABLES D'INTERFACE	
REF			
REC3905397	Caterpillar, Perkins	AM29	
REC3906219	TOHATSU	AM30	
REC3906891	MAN	AM31	
REC3905015	Personal Water Craft KAWASAKI cable kit		

INTERFACE AM01		INTERFACE AM01	
REF			
REC3902358	AM01		
REF			
REC3902407	HONDA / TOHATSU, PGM (F)	AM02	
REC3902247	2 pin Mercury, Mercruiser	AM04	
REC3902250	4 vie Mercury, Mercruiser	AM05	
REC3902413	YAMAHA / SELVA	AM06	
REC3909234	6 pin VOLVO PENTA	AM07	
REC3902467	VOLVO KAD - TAMD	AM09	

INTERFACE AM01		INTERFACE AM01	
REF			
REC3902864	Steyr	AM12	
REC3902865	Evinrude	AM13	
REC3902907	VOLVO, Mercruiser <sup>6785</sup> , MEFI-4, 4B,3,2,1, CRUSADER	AM14	
REC3902931	Yanmar	AM15	
REC3903560	Suzuki	AM22	
REC3905265	Mercruiser / VM D-Tronic	AM27	
REC3908405	PARSUN	3151/ AP54	

INTERFACE AM01 CAN		INTERFACE AM01 CAN	
REF			
REC3903008	AM01CAN		

INTERFACE AM01 CAN		INTERFACE AM01 CAN	
REF			
REC3903502	Volvo, EGC-EV	AM18	
REC3910127	Mercury, mariner, cummins 2010+, Mandos MCM, Smartcraft	AM25	
REC3907103	Marine STEYR	AM32	
REC3907642	YANMAR MARINE	AM33	

**LUBRICANTS RECLUBE**

**LUBRICANTES RECLUBE**

**LUBRIFICANTE RECLUBE**

**LUBRIFIANTS RECLUBE**

LUBRICANT	LUBRICANTE	LUBRIFICANTE	HUILE
-----------	------------	--------------	-------

**2 STROKES TC-W3**

REF	1 L	6	✓	✓	✓
REC2TU6	1 L	6			
REC2TU3	5 L	3	✓		

NMMA TC-W3 (NMMA, National Marine Manufacturers Association)



**100% SYNTHETIC - 4 STROKES**

SAE	REF	1 L	6	✓	✓	✓
5W40	REC5W40U6	1 L	6			
	REC5W40U3	5 L	3	✓	✓	
	REC5W40205L	205L	1			

API SN/CF  
ACEA A3/B3/B4  
MB 229.3  
VW 502.00/505.00  
RN 710  
OPEL A&B  
JASO MA2



**SYNTHETIC PREMIUM OIL - 4 STROKES (NMMA FC-W) - HIGH HTHS**

SAE	REF	1 L	6	✓	✓	✓
10W30	REC10W30U6	1 L	6			
	REC10W30U3	5 L	3			
	REC10W3020L	20 L	1	✓		
	REC10W3050L	50 L	1			
	REC10W30205L	205 L	1			
10W40	REC10W40U6	1 L	6			
	REC10W40U3	5 L	3			
	REC10W4020L	20 L	1	✓		
	REC10W4050L	50 L	1			
	REC10W40205L	205 L	1			

NMMA FC-31015T (NMMA, National Marine Manufacturers Association)  
API SJ/SG

NMMA FC-11815R (NMMA, National Marine Manufacturers Association)  
API SJ/SG



**MULTIGRADE HIGH PERFORMANCE - 4 STROKES DIESEL - TURBO**

SAE	REF	5 L	3	✓	✓	✓
15W40	REC15W40U3	5 L	3			
	REC15W4020L	20 L	1	✓		
	REC15W4050L	50 L	1			
	REC15W40205L	205 L	1			

API CI-4/SL  
ACEA E7  
Caterpillar ECF-1<sup>a</sup>  
Cummins CES 20071/72/76/77/78  
MACK EO-M+  
MAN M3275  
MB 228.3  
MTU Level 2  
Renault RLD/RLD-2  
Volvo VDS-2 VDS-3



**SYNTHETIC OIL - 4 STROKES**

- For engines with high RPM and heavy loads.    - Para motores con cargas y RPM elevadas.    - Adatto a motori con elevati RPM e carichi pesanti.    - Adapté aux moteurs avec des hauts RPM.

SAE	REF	1 L	6	✓	✓	✓
25W40	REC25W40U6	1 L	6			
	REC25W40U3	5 L	3	✓		
	REC25W40205L	205L	1			
25W50	REC25W50U6	1 L	6			
	REC25W50U3	5 L	3	✓		
	REC25W5020L	205L	1			

NMMA FC13101T (NMMA, National Marine Manufacturers Association)  
API SJ/SG

NMMA (NMMA, National Marine Manufacturers Association)  
FCW/FCW-CAT



**SAE 30**

- High detergent-dispersing power, providing an adequate cleaning of the internal parts of the engine.
  - Excellent protection against wear and corrosion. Prolongs engine life.
  - Adequate alkaline reserve, neutralizing the acids formed during the engine work.
  - High resistance to foaming.
  - High oxidation stability.
- Elevado poder detergente-dispersante, con lo que proporciona una adecuada limpieza en las partes internas del motor.
  - Excelente protección contra el desgaste y contra la corrosión. Prolonga la vida del motor.
  - Adecuada reserva alcalina, neutralizando los ácidos formados durante el trabajo del motor.
  - Alta resistencia a la formación de espuma.
  - Gran estabilidad a la oxidación.
- Elevato potere di dispersione del detergente, che garantisce un'adeguata pulizia delle parti interne del motore.
  - Eccellente protezione contro l'usura e la corrosione. Prolunga la vita del motore.
  - Adeguata riserva alcalina, che neutralizza gli acidi che si formano durante il lavoro del motore.
  - Elevata resistenza alla formazione di schiuma.
  - Elevata stabilità all'ossidazione.
- Haut pouvoir de dispersion des détergents, assurant un nettoyage adéquat des parties internes du moteur.
  - Excellente protection contre l'usure et la corrosion. Prolonge la durée de vie du moteur.
  - Réserve alcaline adéquate, neutralisant les acides formés pendant le travail du moteur.
  - Haute résistance à la formation de mousse.
  - Grande stabilité à l'oxydation.

**NEW**

SAE	REF				
30	RECSAE30U6	1 L	6		ACEA E2 API SJ API CF API CF-4
	RECSAE30U3	5 L	3		

**SYNTHETIC OIL FOR IPS TRANSMISSION**

SAE	REF				
75W90	REC75W90U6	1 L	6		
	REC75W90U3	5 L	3		✓ API GL-5
	REC75W9020L	20 L	1		
80W90	REC80W90U6	1 L	6		
	REC80W90U3	5 L	3		✓ API GL-5
	REC80W9015L	15 L	1		
	REC80W9050L	50 L	1		
75W140 HIGH PERFORMANCE	REC75W140U3	5 L	3		API GL-5 API MT-1 ARVIN MERITOR 0-76-M Mack GO-J MIL-PRF-2105E SAE J2360 Scania STO 1:0 - 2:0A ZF TE-ML 05A - 07A - 12N - 16F - 19C - 21A

**HIGH PERFORMANCE**
**PUMP & OIL KIT WITH ADAPTER**
**KIT DE BOMBA Y ACEITE CON ADAPTADOR**
**KIT POMPA E OLIO CON ADATTATORE**
**KIT DE POMPE ET D'HUILE AVEC ADAPTEUR**

REF		CONTENT
RECLUBEKIT	1 L	REC80W90U6 + REC55005 + REC55006

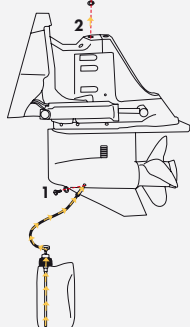

REC80W90U6



REC55005



REC55006

**NEW**
**ATF SYNTHETIC HYDRAULIC FLUID FOR AUTOMATIC TRANSMISSION**

- AUTOMATIC TRANSMISSION  
- Especially suited for automatic transmissions, servo-devices, power-assisted steering.
- TRANSMISSION AUTOMÁTICA  
- Especialmente indicado para transmisiones automáticas, servomecanismos y direcciones asistida.
- TRASMISSIONE AUTOMATICA  
- Specificamente indicato per trasmissioni automatiche, servomeccanismi, servotimoni.
- HUILE HYDRAULIQUE DEXRON III  
- Spécifiquement indiqué pour les transmissions automatiques, servomécanismes et aux directions hydrauliques.

REF			
RECATFU3	5 L	3	
			GM DEXRON III G / IID-II E FORD MERCON ALLISON C-4 TES-228, TES 389 MB 236.9 - MB 236.5 ZF TE-ML 02F/03D/04D/05L/09/11A/17C/21L Caterpillar TO-2 Man 339 TYPE V1/Z1 Voith 55.6336 XXX VOLVO STD 1273.40/127.341 FORD SQM9010B / M2C138CJ -M2C166H - M2C185A
RECATFU6	1 L	6	





**HYDRAULIC OIL ISO46**

- High quality micro-filtered fluids for extreme pressure.
- Suitable for hydraulic systems such as gangways, tenderlifts, cranes, etc.

**ACEITE HIDRÁULICO ISO46**

- Fluidos microfiltrados de alta calidad para presiones extremas.
- Indicado para sistemas hidráulicos como pasarelas, tenderlift, grúas, etc.

**OLIO IDRAULICO ISO46**

- Fluidi microfiltrati di alta qualità per pressioni estreme.
- Adatto per sistemi idraulici come passerelle, tender lift, gru, ecc.

**HUILE HYDRAULIQUE ISO46**

- Fluides microfiltrés de haute qualité pour une pression extrême.
- Convient aux systèmes hydrauliques tels que les passerelles, les monte-charges, les grues, etc.



REF		
RECISO46U3	5 L	3
RECISO46U6	1 L	6

**MARINE GREASE. 100% NON-WATER-SOLUBLE**

- Semi-synthetic marine grease with a lithium and calcium base, thick and blue.
- Especially formulated for all nautical uses, including cable glands and foldable propellers, thanks to good adherence to metal.

**GRASA MARINA. 100% INSOLUBLE AL AGUA**

- Grasa marina semisintética con base de litio-calcio, de cuerpo espeso y color azul.
- Para todo tipo de aplicaciones náuticas incluso prensaestopas y hélices plegables, gracias a la buena adhesión al metal.

**GRASSO MARINO. 100% INSOLUBILE IN ACQUA**

- Grasso marino semisintetico a base di litio-calcio, di aspetto denso e di colore azzurro.
- Specificamente formulato per applicazioni nautiche di tutti i tipi, compresi premistoppa ed eliche pieghevoli, grazie all'alta aderenza ai metalli.

**GRAISSE MARINE 100% INSOLUBLE À L'EAU**

- Graisse marine semi-synthétique à base de lithium-calcium, d'apparence dense et de couleur bleu clair.
- Spécialement formulé pour tous les types d'applications nautiques, y compris les presse-étoupe et les hélices repliables, grâce à leur forte adhérence aux métaux.

REF		
1 RECGREU1	5 kg	1
2 RECGREU35	3,5 kg	1
3 RECGREU6	450 g	6
4 RECGREU12	400 g	12
5 RECGREU30	100 g	30
MINERAL		
6 RECGREU4	85 g	4



**NEW**



**RECLUBE GUIDE**

**GUÍA RECLUBE**



**GUIDA RECLUBE**

**GUIDE RECLUBE**

SAE	REF			SAE	REF		
10W30	REC10W30205L	205 L		75W140	REC75W140U3	5 L	x 3
	REC10W3020L	20 L			REC75W9020L	20 L	
	REC10W3050L	50 L		75W90	REC75W90U3	5 L	x 3
	REC10W30U3	5 L	x 3		REC75W90U6	1 L	x 6
10W40	REC10W30U6	1 L	x 6	80W90	REC80W9015L	15 L	
	REC10W40205L	205 L			REC80W9050L	50 L	
	REC10W4020L	20 L			REC80W90U3	5 L	x 3
	REC10W4050L	50 L			REC80W90U6	1 L	x 6
15W40	REC10W40U3	5 L	x 3	ATF	REC80W90U3	5 L	x 3
	REC10W40U6	1 L	x 6		REC75W90U3	5 L	x 3
	REC15W40205L	205 L		REC75W90U6	1 L	x 6	
	REC15W4020L	20 L		RECGREU1	5 kg		
25W40	REC15W4050L	50 L		RECGREU12	400 g	x 12	
	REC15W40U3	5 L	x 3	RECGREU4	85 g	x 4	
	REC25W40205L	205 L		RECGREU6	450 g	x 6	
	REC25W40U3	5 L	x 3	RECGREU30	100 g	x 30	
25W50	REC25W40U6	1 L	x 6	RECGREU35	3,5 kg		
	REC25W50205L	205 L		ISO 46	RECISO46U3	5 L	x 3
	REC25W50U3	5 L	x 3	RECISO46U6	1 L	x 6	
	REC25W50U6	1 L	x 6	SAE30	RECSAE30U3	5 L	x 3
2T	REC2TU3	5 L	x 3	RECSAE30U6	1 L	x 6	
	REC2TU6	1 L	x 6				
5W40	REC5W40205L	205 L					
	REC5W40U3	5 L	x 3				
	REC5W40U6	1 L	x 6				

LUBRICANT &  
GREASE

## 2 STROKES OIL

	REF	OEM			
1	RM92-858026QB1U6	92-858026QB1	1 L	6	PREMIUM PLUS
	RM92-858027QB1U3	92-858027QB1	3,8 L	3	PREMIUM PLUS
2	RM92-858037QB1U3	92-858037QB1	3,8 L	3	OPTIMAX /DFI

LUBRICANTES Y  
GRASAACEITE MEZCLA 2  
TIEMPOSLUBRIFICANTE E  
GRASSO

## OLIO MISCELA 2 TEMPI

LUBRIFIANT ET  
GRAISSE

## HUILE 2 TEMPS



## 2-CYCLE OIL TC-W3

- This formulation has outstanding lubricity and miscibility for better mixing of fuel and oil, resulting in a cleaner running engine.
- Recommended for oil injection systems.

ACEITE MINERAL FUERABORDAS  
TC-W3



- Utilize el TC-W3 para obtener mayor potencia en su motor.
- Para los sistemas de inyección de aceite.

OLIO MINERALE PER  
FUORIBORDO TC-W3

- Utilizzare il TC-W3 per ottenere maggior potenza nel motore.
- Raccomandato per i sistemi di iniezione ad olio.

HUILE MINÉRALE 2 TEMPS  
TC-W3

- Utilisez la TC-W3 pour augmenter la puissance de votre moteur.
- Recommandé pour les systèmes d'injection d'huile.

	REF	OEM		
	RM92-858021QB1U6	92-858021QB1	1 L	6
	RM92-858022QB1U3	92-858022QB1	3,8 L	3
	RM92-858023QB1U2	92-858023QB1	9,5 L	2



## SAE 5W40

- For high performance engines.
- Particularly suitable for engines that are subject to frequent starting and stopping.

## SAE 5W40





- Para motores de alto rendimiento.
- Especialmente adecuado para motores que están sujetos a arranques y paradas frecuentes.

## SAE 5W40

- Per motori ad alte prestazioni.
- Particolarmente adatto per motori soggetti a frequenti avviamenti e arresti.



## SAE 5W40

- Pour les moteurs hautes performances.
- Particulièrement adapté aux moteurs soumis à des démarrages et arrêts fréquents.

	REF	OEM				
	REC21363429	21363429	1 L			
	REC21363430	21363430	5 L	✓		API SM

VOLVO  
PENTA

## SAE 10W30

	REF	OEM		
	RM92-8M0086220U6	92-8M0086220	1 L	6
	RM92-8M0086221U3	92-8M0086221	4 L	3

## SAE 10W30

## SAE 10W30

## SAE 10W30

VDS-3 MINERAL GEAR  
OILS

- The high quality of VDS-3 oil allows in certain cases an increase in drain intervals. F

ACEITE MINERALES  
VDS-3



- La alta calidad del aceite VDS-3 permite un aumento en los intervalos de drenaje.

## OLIO MINERALE VDS-3

- L'alta qualità dell'olio VDS-3 consente un aumento degli intervalli di scarico.



## HUILE MINÉRALE VDS-3

- La haute qualité de l'huile VDS-3 permet une augmentation des intervalles de vidange.

	SAE	REF	OEM		
15W40		REC22479638	22479638	1 L	API CI-4
		REC22479642	22479642	5 L	ACEA E5



VOLVO  
PENTA

ENGINES OIL	ACEITE MOTORES	OLIO MOTORE	HUILE MOTEUR
-------------	----------------	-------------	--------------

	SAE	REF	OEM			
1	15W40	RM92-8M0096794U3	92-8M0096794	3,8 L	3	DIESEL
2	25W40	RM92-8M0086224U3	92-8M0086224	3,8 L	3	GAS
	25W40	RM92-8M0086223U6	92-8M0086224	1 L	6	GAS





SYNTHETIC OIL FOR VERADO ENGINES	ACEITE SINTÉTICO PARA MOTORES VERADO	OLIO SINTETICO PER MOTORI VERADO	HUILE SYNTHÉTIQUE POUR VERADO
----------------------------------	--------------------------------------	----------------------------------	-------------------------------

	REF	OEM		
	RM92-8M0086227U3	92-8M0086227	4 L	3
	RM92-8M0086226U6	92-8M0086227	1 L	6







SYNTHETIC OIL FOR MECHANICAL DRIVES	ACEITE SINTÉTICO PARA TRANSMISIONES MECÁNICAS	OLIO SINTETICO PER TRASMISSIONE MECCANICA	HUILE SYNTHÉTIQUE POUR EMBASES MÉCANIQUE
-------------------------------------	---	---	--

	SAE	REF	OEM		
		RM92-8M0121960U12	90-8M0121960	137 ml	12
90		RM92-858064QB1U6	92-858064QB1	1 L	6
		RM92-858065QB1U2	92-858065QB1	9,5 L	2





OIL FOR TRANSMISSION DEXRON III	ACEITE PARA TRANSMISSION DEXRON III	OLIO PER TRASMISSIONE DEXRON III	HUILE POUR TRANSMISSION DEXRON III
---------------------------------	-------------------------------------	----------------------------------	------------------------------------

	REF	OEM				
	REC85122800	85122800	1 L			
	REC1161995	1161995	5 L	✓		API-GL5





MARINE GREASE. 100% NON-WATER-SOLUBLE	GRASA MARINA. 100% INSOLUBLE AL AGUA	GRASSO MARINO. 100% INSOLUBILE IN ACQUA	GRAISSE MARINE 100% INSOLUBLE À L'EAU
---------------------------------------	--------------------------------------	---	---------------------------------------

	REF		
1	RM92-8M0133989U6	280 g	6
2	RM92-8M0133985U4	450 g	4



**GREASE SPRAY PTFE**

- Special long lasting lubricant.
- Its fluidity facilitates the application and its quick drying allows an optimal lubrication even in inaccessible places.
- No sagging.
- High pressure resistance.

REF		
PER35621	500 ml	12

**GRASA DE SPRAY PTFE**

- Lubricante especial de larga duración.
- Su fluidez facilita la aplicación y su secado rápido permite una óptima lubricación incluso en lugares inaccesibles.
- No descuelga.
- Resistencia a altas presiones.

**GRASSO A SPRUZZO PTFE**

- Lubrificante speciale a lunga durata.
- A sua fluidità lo rende facile da applicare e le sue proprietà di asciugatura rapida consentono una lubrificazione ottimale anche in punti inaccessibili.
- Nessun cedimento.
- Resistenza alle alte pressioni.

**GRAISSE EN SPRAY PTFE**

- Lubrifiant spécial longue durée.
- Sa fluidité facilite l'application et son séchage rapide permet une lubrification optimale même dans les endroits inaccessibles.
- Pas d'affaissement.
- Résistance à la haute pression.



**DRY LUBRICAN SPRAY WITH PTFE**

REF	
SOR112045	200 ml

**LUBRICANTE A SECO SPRAY CON PTFE**

**LUBRICANTE A SECO SPRAY CON PTFE**

**LUBRIFIANT A SEC SPRAY PTFE**



**POWER TRIM & TILT FLUID**

REF		
RM92-858074QB1U12	240 g	12

**ACEITE TRIM / TILT**

**OLIO TRIM / TILT**

**HUILE DE TRIM/TILT**



**SYNTHETIC COMPRESSOR OIL**

REF	OEM		VISCO
RM85108974	85108974	250 ml	ISO VG 68

**ACEITE COMPRESOR SINTÉTICO**

**OLIO COMPRESSORE SINTETICO**

**HUILE POUR COMPRESSEUR SYNTHÉTIQUE**



**SILICONE GREASE**

REF	
SOR102002	100 g

**GRASA SILICONA**

**GRASSO SILICONA**

**GRAISSE SILICONE**



5

OIL AND GREASE TOOLS

LEVER GREASE GUN

- Standard Lever grease gun.
- Includes curved pipe and std coupler.
- With Viewer for reservation.
- Will reload without tube.

HERRAMIENTAS PARA GRASA Y ACEITE

PISTOLA DE GRASA

- Incluye manguera curvada y conector standard.
- Con visor para reserva.
- Se recarga sin necesidad de tubo.

ATTREZZI PER OLIO E GRASSO

PISTOLE GRASSO

- Include tubo flessibile curvo e connettore standard.
- Con visora per la prenotazione.
- Si ricarica senza tubo.

OUTILS POUR L'HUILE ET LA GRAISSE

POMPE A GRAISSE

- Comprend un tuyau incurvé et un connecteur standard.
- Avec viseur pour réservation.
- Il se recharge sans tube.



REF			
1 RECT30201	600 cc	16000 psi	
2 LUB10212			30 cm

RECMAR®

2



REF				
RECLUBETHU02	400 g 500 g bulk	6500-10000 psi	30 cm	RECGREU12



PNEUMATIC GREASE GUN

PISTOLA DE GRASA NEUMÁTICA

PISTOLE PER GRASSO PNEUMATICA

POMPE À GRAISSE PNEUMATIQUE

REF			
RECLUBETHQ01A	400 g 500 g bulk	4500-8000 psi	RECGREU12



NEW



+ OPTIONS INSTAL. P. 20

MIDGET GREASE GUN KIT

KIT PISTOLA + GRASA

KIT PISTOLA + GRASSO

KIT PISTOLET + GRAISSE

- Versatile gun allows for front or top pipe placement.
- Barrel takes grease cartridge or can be bulk loaded.

- Pistola que permite la salida del tubo conector frontal o superior.
- Admite cartuchos o grasa a granel.

- Pistola piccola e molto versatile che permette l'uscita del grasso dal tubo frontale o superiore.
- Utilizza cartuccia o grasso sfuso.

- Pistole qui permet la sortie du tube de connexion avant ou supérieur.
- Prend en charge des cartouches ou de la graisse en vrac.

REF			
RECT30190	3 oz / 85 g bulk	4500 psi 300 k/cm²	RECGREU4

RECMAR®



- All purpose gun operates handy squeeze tubes.
- Includes 2-11/16" pipe and plastic push-type coupler.

- Pistola para tubos de grasa.
- Incluye manguera flexible de 14 cm y adaptador standard.

- Pistola per tubi di grasso.
- Include tubo flessibile da 14 cm e adattatore standard.

- Pistolet pour tubes de graisse.
- Comprend un tuyau flexible de 14 cm et un adaptateur standard.

REF	
RM91-37299Q2	14 cm

QUICKSILVER



BOTTLE GREASE PUMP	PISTOLA DE ACEITE	PISTOLA OLIO	POMPE POUR HUILE
--------------------	-------------------	--------------	------------------

- |  |   |  |   |
|--|---|--|---|
| <ul style="list-style-type: none"> <li>- Lower unit quart pump.</li> <li>- Complete with metal threaded filler fitting.</li> </ul> | <ul style="list-style-type: none"> <li>- Pistola para acoplar en los envases de botella de 1 litro.</li> <li>- Se suministra con kit de adaptación con válvula anti-retorno.</li> </ul> | <ul style="list-style-type: none"> <li>- Pistola da accoppiare a bottiglie da 1 L.</li> <li>- Si vende con kit di accoppiamento con valvola anti-ritorno.</li> </ul> | <ul style="list-style-type: none"> <li>- Pompe pour les bidons de 1 litre.</li> <li>- Livré avec kit d'adaptation avec clapet anti-retour.</li> </ul> |
|--|---|--|---|



REF				
1	REC55005	Bottle grease pump	Pistola de aceite	Pistola olio
2	REC55133M	Metric adaptor (⊘ Suzuki)	Adaptador métrico (⊘ Suzuki)	Adattatore metrico (⊘ Suzuki)
3	REC55133S	Adaptor for Suzuki	Adaptador para Suzuki	Adattatore per Suzuki

**RECMAR®**



ADAPTOR FOR RECLUBE CONTAINERS 1L	ADAPTADOR PARA EMBASES RECLUBE DE 1L	ADATTATORE PER CONTENITORI RECLUBE 1L	ADAPTEUR POUR LES BIDONS DE 1L RECLUBE
-----------------------------------	--------------------------------------	---------------------------------------	--

REF
1
2

**RECMAR®**



METRIC GREASE FITTINGS	KI ENGRASADORES MÉTRICOS	KIT LUBRIFICATORI METRICI	KIT GRAISSEURS MÉTRIQUES
------------------------	--------------------------	---------------------------	--------------------------

REF	0°	45°	90°	
1	LUB11957	x4	x2	x2
2	RECT11958		x4	M6x1



OIL CHANGE KIT	KIT CAMBIO DE ACEITE	KIT CAMBIOE OLIO	KIT VIDANGE D'HUILE
----------------	----------------------	------------------	---------------------

- |   |  |  |   |
|---|--|--|---|
| <ul style="list-style-type: none"> <li>- Reversible pump kit for oil change, winterizing and liquid transfer.</li> <li>- Hose kit.</li> </ul> | <ul style="list-style-type: none"> <li>- Bomba reversible, para cambio de aceite instalada sobre un bidón portátil con mangueras de extracción y 2,5 m de cable eléctrico con pinzas.</li> </ul> | <ul style="list-style-type: none"> <li>- Pompa reversibile, per cambio dell'olio installata sopra un bidone portatile con tubo di estrazione e 2,5 m di cavo elettrico con pinze.</li> </ul> | <ul style="list-style-type: none"> <li>- Pompe réversible pour vidange d'huile installée au-dessus d'un seau portable avec tube d'extraction et 2,5 m de câble électrique avec pince pour batterie</li> </ul> |
|---|--|--|---|

REF				
SH8050-305-426	14,1 l/min	12 V (4,7 A)	403 x 318 mm	3,5 gal 13 l

**SHURflo®**



GREASECASE FILLER	BOMBA DEPÓSITO	POMPA OLIO	POMPE DE REMPLISSAGE
- With check valve venting system to avoid overflow	- Para llenado de colas. - Con válvula de ventilación para evitar derrames.	- Per mettere l'olio nei piedi poppier. - Con valvola di sfiatto per evitare fuoriuscite.	- Pour le remplissage des embases. - Avec valve de ventilation pour éviter les déversements.
REF			
1 REC55133GF	Greasecase filler	Bomba depósito	Pompa olio
2 REC55133M	Metric adaptor (Suzuki)	Adaptador métrico (Suzuki)	Adattatore metrico (Suzuki)
3 REC55133S	Adaptor for Suzuki	Adaptador para Suzuki	Adattatore per Suzuki

**RECMAR®**



- Stainless Steel Engine Oiler. - Includes 3 adaptors fittings: 1/8 x 1/8 NPT 1/4 x 1/8 NPT 16 mm x 1.5 x 1/8 NPT (GMLS) - 75 lb. safety blow off valve - Handles for easy transport - 8 ft. chemical resistant hose with swivel end. - Made in USA.	- Lubricador de motor de acero inoxidable. - Incluye 3 adaptadores: 1/8 x 1/8 NPT 1/4 x 1/8 NPT 16 mm x 1,5 x 1/8 NPT (GMLS) - Válvula de seguridad de 75 lb - Asas para facilitar el transporte - Manguera resistente a productos químicos de 8 pies con extremo giratorio - Fabricado en EE. UU.	- Lubrificatore motore in acciaio inossidabile. - Include 3 raccordi adattatori: 1/8 x 1/8 NPT 1/4 x 1/8 NPT 16 mm x 1,5 x 1/8 NPT (GMLS) - Valvola di sicurezza da 75 lb - Maniglie per un facile trasporto - Tubo flessibile resistente agli agenti chimici da 8 ft con estremità girevole - Prodotto negli Stati Uniti.	- Graisseur de moteur en acier inoxydable. - Comprend 3 raccords adaptateurs : 1/8 x 1/8 NPT 1/4 x 1/8 NPT 16 mm x 1,5 x 1/8 NPT (GMLS) - Soupape de sécurité de 75 lb - Poignées pour un transport facile - Tuyau résistant aux produits chimiques de 8 pieds avec extrémité pivotante - Fabriqué aux États-Unis.
--	--	--	--

REF	Image	Capacity
SSPEL05		2 gal



MANUAL OIL PUMP	BOMBA DE ACEITE MANUAL	POMPA DELL'OLIO MANUALE	POMPE DE VIDANGE D'HUILE MANUELLE
When full it automatically stops.	Quando está lleno se para automáticamente.	Quando pieno arresta automaticamente	Arrêt automatique quand elle est pleine

REF	Capacity (L)	Weight (kg)	Dimensions (mm)	Stroke (mm)	Max. Temp (°C)
1 GS20080	4 L	2.1 kg	496 x 204 mm	9.8	max. 100°C
2 GS20081	6 L	2.4 kg	648 x 204 mm	6.7	
3 GS20082	18 L	4.9 kg	700 x 350 mm	5.8	
4 GS20084	7 L				
5 GS20085	9 L				



- Made of solid brass and PVC.	- Cuerpo de PVC y latón. - Tubos de nylon flexible.	- Corpo in PVC e ottone. - Tubo in nylon flessibile.	- Corps en PVC et laiton. - Tuyau en nylon flexible.
--------------------------------	--	---	---

REF	Length (in)
1 GS20151	
2 SFPHH35003	9"
3 SFPHH76503	17"





**GOLDENSHIP**

**SEAFLO**

**SEAFLO**

- Ideal for pumping water or oils.
- Bomba extractora o trasvase de líquidos.
- Pompa estraitrice o per travaso di liquidi.
- Pompe d'extraction ou transfert de liquide.

REF			
SH3010-000	760 l/h 200GPH	2,4 m	6 mm

**SHURflo**



**6**

**MAINTENANCE**

**COOLANT**

- High performance green antifreeze for marine engines.
- Prevents corrosion and wear of engine components.

**ATTENTION**  
They are NOT chemically compatible so they can NOT be mixed RECOOLGREEN with RECOOLYELLOW

**MANTENIMIENTO**

**REFRIGERANTE**

- Anticongelante verde de alto rendimiento para motores marinos.
- Previene la corrosión y desgaste de los componentes del motor.

**ATENCIÓN**  
NO son compatibles químicamente por lo que NO se puede mezclar RECOOLGREEN con RECOOLYELLOW

**MANUTENZIONE**

**REFRIGERANTE**

- Antigelo verde ad alte prestazioni per motori marini.
- Previene la corrosione e l'usura dei componenti del motore.

**ATTENZIONE**  
NON sono chimicamente compatibili quindi NON possono essere miscelati RECOOLGREEN con RECOOLYELLOW



**MAINTENANCE**

**LIQUIDE DE REFROIDISSEMENT**

- Antigel vert haute performance pour moteurs marins.
- Empêche la corrosion et l'usure des composants du moteur.

**ATTENTION**  
Ils NE sont pas chimiquement compatibles et NE peuvent donc pas être mélangés RECOOLGREEN avec RECOOLYELLOW



REF		
RECOOLGREENU3	5 L	3
RECOOLYELLOWU3	5 L	3



**NEW**

**CARBURATOR & CHOKE CLEANER**

- Dissolves gum, varnish dirt and carbon deposits.
- Restore power & performance.
- Reduce fuel consumption.

REF	
GEGC15	354 g

**LIMPIADOR CARBURADOR Y STARTER**

- Asegura arranques fáciles y ralenti suave.
- Despega los aros de los pistones.
- Restablece la potencia del motor.

**PULITORE CARBURATORE**

- Assicura partenze più facili e un minimo stabile.
- Lubrifica le fasce dei pistoni.
- Ristabilizza la potenza del motore.

**NETTOYANT CARBURATEUR**

- Assure des démarrages faciles et un ralenti en douceur.
- Décolle les segments du piston.
- Restaure la puissance du moteur.



**RING CLEAN**

- Restores rough-running engines and fuel efficiency.
- Eliminates carbon deposits, gum & varnish.
- Cleans injectors & valves.
- Remove moisture build-up.

REF	
STA95616	500 ml

**LIMPIEZA DE ANILLOS**

- Restaura el funcionamiento del motor y la eficiencia del combustible.
- Elimina los depósitos de carbono, goma y barniz.
- Limpia inyectores y válvulas.
- Elimina la acumulación de humedad.



**PULIZIA ANELLI**

- Ripristina il funzionamento irregolare dei motori e l'efficienza del carburante.
- Elimina i depositi carboniosi, le gomme e le vernici.
- Pulisce iniettori, valvole e altro.
- Rimuove gli accumuli di umidità.

**NETTOYAGE DE L'ANNEAU**

- Rétablit le fonctionnement irrégulier des moteurs et l'efficacité du carburant.
- Élimine les dépôts de carbone, les gommages et les vernis.
- Nettoie les injecteurs, les soupapes et autres.
- Élimine l'accumulation d'humidité.



**CARBURATOR & FUEL INJECTOR CLEANER**

- Improves power and acceleration.
- Lubricates entire fuel system.
- Maximizes fuel economy.

**LIPIADOR INYECTORES Y CARBURADORES**



- Mejora la potencia y aceleración.
- Lubrifica todo el sistema de combustible.
- Maximiza el ahorro de combustible.

**PULITORE INIETTORE E CARBURATORE**

- Migliora l'accelerazione.
- Lubrifica tutto il sistema di combustione.
- Allunga la vita degli iniettori.

**NETTOYANT D'INJECTEURS ET CARBURATEURS**

- Améliore la puissance et l'accélération.
- Lubrifie l'ensemble du système d'alimentation en carburant.
- Optimise les économies de carburant.

REF			
1 GE21204	250 ml	130 L	Gasoline / Diesel
2 GE15210			Diesel

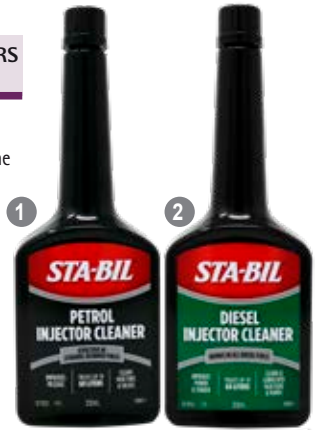



Maximum concentration formulation designed to precisely decarbonize injector holes and clean the injection system. Restores the optimal spray pattern for more complete and efficient combustion.

Formulación de máxima concentración diseñada para descarbonizar con precisión los orificios de las toberas y limpiar las bombas de inyección. Restablece el patrón de pulverización óptimo para una combustión más completa y eficiente.

Formula altamente concentrata progettata per decarbonizzare con precisione i fori degli iniettori e pulire il sistema di iniezione. Ripristina il getto d'acqua ottimale per una combustione più completa ed efficiente.

Formule hautement concentrée conçue pour décarboniser précisément les orifices des injecteurs et nettoyer le système d'injection. Restaure une pulvérisation optimale pour une combustion plus complète et plus efficace.

REF			
RECLUBE100U12	300 ml	130 L	Gasoline 12
RECLUBE200U12			Diesel 12



**FOGGING OIL**

- Prevents corrosion when storing inboard or outboard engines for a extended period of time.
- Special formula makes starting engine after storage quick and easy.

**ACEITE DE INVERNAJE**

- Para inyectar en los carburadores.
- Protege las paredes de los cilindros, aros de pistones y otras superficies de la cámara de combustión durante los periodos de invernaje, facilitando el arranque del motor posterior.

**OLIO INVERNAGGIO**

- Da inserire nei carburatori dei motori.
- Protegge le pareti dei cilindri, le fasce dei pistoni e altre superfici della camera di combustione durante il periodo di invernaggio, facilitando la partenza del motore dopo questo periodo.

**FOGGING OIL**

- Pour injecter dans les carburateurs des moteurs.
- Il protège les parois des cylindres, segments et autres surfaces de la chambre de combustion pendant les périodes d'hivernage, facilitant le démarrage du moteur après cette période.

REF	
GE22001	340 g



Protect your engine in winter. Oil that coats cylinders, pistons, and rings, displaces moisture, and prevents corrosion.

Protege tu motor en invierno. Aceite que recubre cilindros, pistones y segmentos, desplaza humedad y previene la corrosión.

Proteggi il tuo motore in inverno. Olio che ricopre cilindri, pistoni e fasce elastiche, allontana l'umidità e previene la corrosione.

Protégez votre moteur en hiver. Huile qui enrobe les cylindres, les pistons et les segments, chasse l'humidité et prévient la corrosion.

REF		
RECLUBE301U6	1 L	6



**ENGINE PROTECTOR**

- Oil & grease made, protects from rust & corrosion external engine surface during winter storage.
- Removes salt deposit and loosens rusted parts.
- Easy to remove.

**PROTECTOR DE MOTOR**

- Producto a base de aceites y grasas que protege del óxido y la corrosión las superficies exteriores y partes eléctricas durante el invernaje.
- Evita la formación de agarrotamientos debido a la presencia de salitre.
- Se elimina fácilmente.

**PROTETTORE MOTORE**

- Prodotto a base di olio e grasso che protegge dall'ossidazione e dalla corrosione le superfici esterne e parti elettriche dei motori durante l'invernaggio.
- Evita la formazione dell'ossidazione dovuta alla presenza del salmastro.
- Si elimina facilmente.

**PROTECTION DU MOTEUR**

- Produit à base d'huiles et de graisses qui protège les surfaces extérieures et les parties électriques des moteurs de la rouille et de la corrosion pendant l'hivernage.
- Il empêche la formation de crises dues à la présence de salpêtre.
- Il s'enlève facilement.

REF	
GS90090	500 ml



**DIELECTRIC PROTECTOR**

- Prevents humidity and corrosion of all electric and mechanical parts in marine engines.
- Specially indicate for winter storages and maintenance in the season.

**PROTECTOR DIeléCTRICO**

- Protege de la humedad y oxidación todos las partes eléctricas y mecánicas de los motores marinos.
- Ideal para invernaje de motores y mantenimiento de temporada.

**PROTETTORE DIELETTICO**

- Protegge dalla umidità e dall'ossidazione tutte le parti elettriche e meccaniche dei motori marini.
- Ideale per invernaggio dei motori e manutenzione di lunga durata.

**PROTECTEUR DIéLECTRIQUE**

- Protège toutes les pièces électriques et mécaniques des moteurs marins contre l'humidité et l'oxydation.
- Idéal pour l'hivernage des moteurs et l'entretien saisonnier.

REF	
GS90092	400 ml



**DIESEL ANTI-FREEZE**

- Prevents fuel freezing and filter clogging.
- Ensures fuel flow at low temperatures.
- Allows the engine to operate in extreme climates.
- Protects the injection pump, injectors, and pipes.

**ANTICONGELANTE DIESEL**

- Evita la congelación del combustible y la obstrucción de filtros.
- Garantiza el flujo de combustible a bajas temperaturas.
- Permite el funcionamiento del motor en climas extremos.
- Protege la bomba de inyección, inyectores y tubos.

**STABILIZZATORE BENZINA/DIESEL**

- Previene il congelamento del carburante e l'ostruzione dei filtri.
- Garantisce il flusso di carburante a basse temperature.
- Consente il condizionamento del motore in condizioni climatiche estreme.
- Protegge la pompa di iniezione, gli iniettori e i tubi.

**STABILISATEUR D'ESSENCE/DIESEL**

- Empêche le gel du carburant et l'obstruction des filtres.
- Garantit le débit de carburant à basse température.
- Permet le fonctionnement du moteur dans des conditions climatiques extrêmes.
- Protège la pompe d'injection, les injecteurs et les tuyaux.



REF			
RECLUBE302U6	1 L	450	Diesel 6



**FUEL/DIESEL STABILIZER**

Diesel fuel stabilizer keeps fuel fresh for quick and easy starting after storage. Suitable for all engines that you plan to store for periods of 30 days to 24 months to keep the fuel fresh, eliminating the need to drain the tank.

**ESTABILIZADOR DE GASOLINA/DIESEL**

El estabilizador mantiene el combustible fresco para un arranque rápido y sencillo después del almacenamiento. Apto para todos los motores que planeen almacenar entre 30 días y 24 meses para mantener el combustible fresco, eliminando la necesidad de vaciar el tanque.

**STABILIZZATORE BENZINA/DIESEL**

Lo stabilizzatore mantiene il carburante fresco per un avviamento rapido e semplice dopo il rimessaggio. Adatto a tutti i motori che si prevede di riporre per un periodo compreso tra 30 giorni e 24 mesi, per mantenere il carburante fresco, eliminando la necessità di svuotare il serbatoio.

**STABILISATEUR D'ESSENCE/DIESEL**

Ce stabilisateur préserve la fraîcheur du carburant pour un démarrage rapide et facile après le stockage. Convient à tous les moteurs que vous prévoyez de stocker entre 30 jours et 24 mois pour préserver la fraîcheur du carburant, évitant ainsi de vider le réservoir.



REF			
RECLUBE101U12 RECLUBE201U12	300 ml	130 L	Gasoline Diesel 12



- Keeps fuel fresh and allows for easier starts after periods of storage.
- Removes water, cleans carburetors and fuel injectors.
- Contains antioxidant to prevent rust and corrosion.

- Elimina el agua, limpia los carburadores e inyectores.
- Contiene antioxidantes.
- No requiere vaciar el depósito para el invierno y mantiene el combustible fresco para un rápido y fácil arranque.

- Elimina l'acqua, pulisce i carburatori e iniettori.
- Contiene antiossidanti.
- Non è necessario svuotare il serbatoio per l'invernaggio e mantiene il carburante fresco per una rapida e facile partenza.

- Élimine l'eau, nettoie les carburateurs et les injecteurs.
- Contient des antioxydants.
- Il ne nécessite pas de vider le réservoir pour l'hivernage et maintient le carburant frais pour un démarrage rapide et facile.

REF			
1 STA14808	250 ml	150 L	Gasoline
2 GE22207	475 ml	150 L	Gasoline
3 GE22254	946 ml	1.200 L	Diesel
4 GE22239	236 ml	38 L	



**GASOLINE ADDITIVE**

Power and protection for your engine, cleans the system, protects key parts and ensures efficiency with gasoline and ethanol.

**ADITIVO GASOLINA**

Potencia y protección para tu motor, limpia el sistema protege partes clave y asegura eficiencia con gasolina y etanol.

**ADDITIVO BENZINA**

Potenza e protezione per il tuo motore, pulisce il sistema, protegge le parti chiave e garantisce l'efficienza con benzina ed etanolo.

**ADDITIF ESSENCE**

Puissance et protection pour votre moteur, nettoie le système, protège les pièces clés et assure l'efficacité avec l'essence et l'éthanol.



REF			
RECLUBE102U12	300 ml	130 L	Gasoline 12

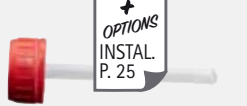

- Eliminates and prevents ethanol fuel problems.
- Reduces all emissions.
- Prevents fuel oxidation and stabilizes fuel chemistry for at least 1 year.
- Eliminates carbon build-up.
- Increases fuel economy.

- Elimina y previene los problemas del etanol.
- Reduce todas las emisiones y el consumo de combustible.
- Estabiliza la química del combustible durante 1 año.
- Elimina la producción de carbonilla.

- Elimina e previene i problemi dell'etanolo.
- Riduce tutte le emissioni e il consumo di combustibile.
- Stabilizza la chimica del combustibile durante 1 anno.
- Elimina la produzione di residui carboniosi.

- Élimine et prévient les problèmes d'éthanol.
- Réduit toutes les émissions et la consommation de carburant.
- Stabilise la chimie du carburant pendant 1 an.
- Réduit l'entretien du système de carburant.
- Élimine la production de charbon.

REF			
STA93008	237 ml	475 L	
STA93016	473 ml	950 L	



**DESCALER**

- Powerful acid treatment formulated to safely and effectively remove salt scale, rust, and mineral deposits from engine cooling circuits.
- Restores system thermal efficiency and prevents overheating.

**DESINCRUSTANTE**

- Potente tratamiento ácido formulado para eliminar de forma segura y eficaz las incrustaciones de sal, sarro, óxido y depósitos minerales de los circuitos de refrigeración del motor.
- Restaura la eficiencia térmica del sistema y previene el sobrecalentamiento.

**DISINCROSTANTE**

- Potente trattamento acido formulato per rimuovere in modo sicuro ed efficace incrostazioni saline, ruggine e depositi minerali dai circuiti di raffreddamento del motore.
- Ripristina l'efficienza termica del sistema e previene il surriscaldamento.

**DÉTARTRANT**

- Traitement acide puissant formulé pour éliminer efficacement et en toute sécurité le tartre, la rouille et les dépôts minéraux des circuits de refroidissement du moteur.
- Restaure l'efficacité thermique du système et prévient la surchauffe.

REF		
RECLUBE300U3	5 L	3



**DESCALING ENGINE FLUSH**

- Removes scale, zebra mussels, general marine growth and vegetation from all marine engines.

**DESCALCIFICADOR DE MOTOR**



- Limpiador para eliminar las incrustaciones, algas, y suciedad en los motores marinos.
- No daña las juntas ni impulsores de goma.

**DECALCIFICANTE MOTORE**

- Pulitore per eliminare le incrostazioni, alghe, e sporizia nei motori marini.
- Non danneggia guarnizioni e giranti in gomma.

**DÉTARTRANT MOTEUR**

- Nettoyant pour éliminer le tartre, les algues et la saleté dans les moteurs marins.
- N'endommage pas les joints ou les turbines en caoutchouc.

REF			CONCENTRATE
1 TRE1212MG	1 Gal 3.785 L	California Marine Life Toxicity Test.	1:4 (1 Buster x 4 water)
2 STA83900EUR	3,8 L		



**MARINE GROWTH REMOVER**

- Barnacle buster is a safe, non-toxic, and biodegradable marine growth remover specifically formulated to be a fast, safe, and cost effective alternative to mechanical cleaning of water cooled equipment.
- It can safely be recirculated through the sea water cooling systems of main engines, generators, air conditioners, etc.

**LIMPIEZA DE CIRCUITOS CONCENTRADO**

- Barnacle buster elimina el crecimiento de microorganismos marinos de forma segura, no tóxica y es 100% biodegradable.
- Formulado para ofrecer una alternativa rápida, segura y rentable para la limpieza de los sistemas de refrigeración con agua de mar sin dañar juntas ni metales.

**PULIZIA DI CIRCUITI CONCENTRATI**

- Barnacle buster elimina la crescita di microorganismi marini in modo sicuro, non tossico ed è biodegradabile al 100%.
- Formulato per offrire un'alternativa rapida, sicura ed economica per la pulizia dei sistemi di raffreddamento con acqua di mare senza danneggiare guarnizioni o metalli.

**NETTOYAGE DU CIRCUIT CONCENTRE**

- Peut être recyclé en toute sécurité à travers les systèmes de refroidissement d'eau de mer. 100% Biodégradable.
- Élimine tous les coquillages et tous les autres dépôts minéraux.
- Peut être utilisé en: systèmes de réfrigération, de climatisation, systèmes d'eau potable, échangeurs de température, tours de refroidissement, réfrigérateurs, chauffe-eau...

REF			CONCENTRATE
TRE1206MQ	1/4 Gal	0.95 l	California Marine Life Toxicity Test.
TRE1206MG	1 Gal	3.785 l	
TRE1206MP	5 Gal	18,9 l	



**FUEL TANK CLEANER**

- Exceptionally effective at cleaning sludge and algae from gasoline and diesel tanks.
- Slows the recurrence of new algae that can contaminate fuel.
- A revolutionary new additive that replaces expensive fuel polishing and tank cleaning.

**LIMPIADOR DEPÓSITOS**



- Excepcionalmente efectivo en la limpieza de lodos y algas en depósitos de gasolina o diesel.
- Retrasa la formación de nuevas algas que puedan contaminar el combustible.
- Revolucionario aditivo que reemplaza las costosas limpiezas de los depósitos.

**PULITORE SERBATOIO**

- Eccezionale efficacia nella pulizia dal fango e alghe nel serbatoio benzina o diesel.
- Ritarda la formazione di nuove alghe che possono contaminare il combustibile.
- Rivoluzionario aditivo che rimpiazza i costosi sistemi di pulizia dei serbatoi.

**NETTOYANT RÉSERVOIR**

- Exceptionnellement efficace pour nettoyer les boues et les algues dans les réservoirs d'essence ou de diesel.
- Il retarde la formation de nouvelles algues qui peuvent contaminer le carburant.
- Additif révolutionnaire qui remplace les systèmes coûteux de nettoyage des réservoirs.

REF		
STA93664	1,9 L	950 L
STA93116	473 ml	1.900 L



**PORTABLE CLEANING EQUIPMENT**

- Engine overheating, clogged pipes, poor heat transfer on air conditioning & refrigeration systems, small parts cleaning

**EQUIPO DE LIMPIEZA PORTÁTIL**

- Pequeños equipos de aire acondicionado, generadores, sistemas de refrigeración, etc.

**PULIZIE PORTATILI PER BARCHE**

- Piccoli impianti di condizionamento, generatori, sistemi di raffreddamento, ecc.

**ÉQUIPEMENT DE NETTOYAGE PORTABLE**

- Petit système de climatisation et de réfrigération, groupe électrogène.

REF				
TRE1245E	220V AC 12V	40' 750 HP	Ø INT 1,5"	1-20 GAL



**SALT OFF**

- It's specifically formulated to quickly and effectively remove salt deposits from metal, fiberglass, plastic or painted surfaces.
- It contains special polymers that bond to the treated surface to help prevent the formation of future deposits.

**ANTISALITRE**

- Diseñado especialmente para eliminar sedimentos de sal de cualquier superficie pintada, de metal, fibra de vidrio, vinilo, caucho, cristal o plástico.
- Genera una capa de polímeros que evita futuras sedimentaciones.

**ANTISALITRE**

- Appositamente progettato per rimuovere depositi di sale da qualsiasi superficie verniciata, metallo, fibra di vetro, vinile, gomma, vetro o plastica.
- Genera uno strato di polimeri che impedisce la futura sedimentazione.

**PRODUIT ANTI-SEL**

- Spécialement conçu pour éliminer les dépôts de sel sur toute surface peinte, métal, fibre de verre, vinyle, caoutchouc, verre ou plastique.
- Le revêtement PTEF® protège dès lors le moteur contre la rouille et la corrosion.

REF	
STA93900	3,78 L
STA93922	650 ml
STA93932	1 L
STA94100	



STA94100



**NEUTRA-SALT**

- Dissolves salt and salt deposits.
- Prevents rust and corrosion (includes a corrosion inhibitor which leaves a protective coating on all metal surfaces).

- Disuelve la sal de los depósitos.
- Previene el óxido y la corrosión (incluye un inhibidor de corrosión que deja una capa protectora en todas las superficies metálicas).

- Scioglie il sale dei depositi.
- Previene ruggine e corrosione (include un inibitore di corrosione che lascia uno strato protettivo su tutte le superfici metalliche).

- Il dissout les dépôts de sel.
- Empêche la rouille et la corrosion (comprend un inhibiteur de corrosion qui laisse une couche protectrice sur toutes les surfaces métalliques).

REF	
REC21687793	950 ml
REC21687796	3.8 L



**7**

**PAINTS**

**PAINT KIT**

- Two components polyurethane paint.
- Easy application by brush or air pistol.
- Performance for one kit: 1 layer of paint = 10 m2, 2 layers of paint = 6 m2

**PINTURAS**

**KIT DE PINTURA**

- Pintura de poliuretano bicomponente.
- Puede aplicarse a pistola o brocha.
- Rendimiento por un kit: 1 capa = 10 m2, 2 capas = 6 m2.

**PITTURE**

**KIT DI VERNICE**

- Pitture in poliuretano bicomponente, composto da pittura base, indurente e diluente.
- Rendimento per 1 kit: 1 strano = 10 m2, 2 strati = 6 m2

**PEINTURES**

**KIT DE PEINTURE**

- Peinture polyuréthane bi-composants, composé d'une base et d'un durcisseur, plus le diluant.
- Rendement pour 1 kit: 1 couche = 10 m2, 2 couches = 6 m2

REF		COLOUR	COLOR	COLORE	COLEUR
PS4688	Mer cruiser	Black	Negro	Nero	Noir
PS4706	Volvo	Red 72	Rojo 72	Rosso 72	Rouge 72
PS4707	Volvo	Green water 72	Verde agua 72	Verde acqua 72	Vert acqua 72



SPRAY PAINT	PINTURA EN SPRAY	PITTURE SPRAY	PEINTURE EN SPRAY		
REF					
GS90001					
GS90012	SPRAY PRIMER	IMPRIMACIÓN MOTOR	PRIMER PER MOTORI	PRIMER POUR MOTEUR	400 ml
GS90013					
GS90008					
GS90009	ANTIFOULING FOR STERN-DRIVES	ANTIFOULING PARA COLAS	ANTIFOULING PER PIEDI	ANTIFOULING POUR EMBASES	400 ml
GS90010					
GS90011					



REF	COLOUR	COLOR	COLORE	COLEUR	
GS90019	Clear Varnish	Barniz transparente	Vernice trasparente	Vernis transparent	
GS90006	Caterpillar Yellow	Amarillo	Giallo	Jaune	
GS90057	Caterpillar White	Blanco	Bianco	Blanc	
GS90053	Cummins White	Blanco	Bianco	Blanc	
GS90054	Cummins White bone	Blanco hueso	Bianco osso	blanc os	
GS90063	Detroit Diesel Silver	Plateado	Argento	Argent	
GS90037	Evinrude Blue XP	Azul XP	Blu XP	XP bleu	
GS90038	Honda Grey Metal	Gris metalizado	Grigio metallizzato	Gris métallisé	
GS90023	Honda Silver Metal	Plata met.	Argento metallizzato	Argent métallisé	
GS90072	Honda Sporty white	sporty blanco	sporty bianco	sporty blanc	
GS90058	IVECO / AIFO Red	Rojo	Rosso	Rouge	
GS90030	Johnson White (1972-90)(1993+)	Blanco (1972-90)(1993+)	Bianco (1972-90) (1993+)	Blanc (1972-90)(1993+)	
GS90026	Johnson White (1981-83)	Blanco (1981-83)	Bianco (1981-83)	Blanc (1981-83)	
GS90039	Johnson Silver Metal	Plata metalizado	Argento metallizzato	Argent métallisé	
GS90074	Lombardini Metal gray	Gris metal	Grigio metallo	Gris métal	
GS90040	Mariner Grey	Gris	Grigio	Gris	
GS90002	Mercury Mercruiser Black	Negro	Nero	Noir	
GS90076	Mercury Cold fusion white	Cold fusion blanco	Cold fusion bianco	Cold fusion blanc	
GS90077	Mercury Warm fusion white	Warm fusion blanco	Warm fusion bianco	Warm fusion blanc	
GS90069	Mercury Verado Silver	Plata	Argento	Argent	
GS90059	Mariner Grey 94	Gris 94	Grigio 94	Gris 94	
GS90056	NanniDiesel Blue Metal	Azul Metal	Blu Metallizzato	Bleu métal	
GS90062	OMC Cobra Stern-drive	Cola Cobra	Piede Cobra	Embase Cobra	
GS90041	Onan Ivory	Marfil	Ivory	Ivory	
GS90049	Parsun Black	Negro	Nero	Noir	
GS90075	Parsun Traffic white Ral9016	Traffic blanco Ral9016	Traffic bianco Ral9016	Traffic blanc Ral9016	
PS114699	Perkins Green Metal	Verde Metal	Verde Metallizzato	Vert métallisé	400 ml
GS90060	Perkins Blue (1983+)	Azul (1983+)	Blu (1983+)	Bleu (1983+)	
GS90061	Perkins Blue (1987)	Azul (1987)	Blu (1987)	Bleu (1987)	
GS90068	Selva Pure white	blanco puro	bianco puro	blanc pur	
GS90031	Solé Diesel Blue	Azul	Blu	Bleu	
GS90032	Suzuki Silver (1983-89)	Plateado (1983-89)	Argento (1983-89)	Argent (1983-89)	
GS90025	Suzuki Grey Metal	Gris metalizado	Grigio metallizzato	Gris métallisé	
GS90042	Suzuki Black Metal	Negro metalizado	Nero Metallizzato	Noir Métallisé	
GS90050	Suzuki Nebular black	Nebular negro	Nebular negro	Nebular noir	
GS90051	Suzuki Cool white	Cool blanco	Cool bianco	Cool blanc	
GS90052	Suzuki Super cool white	Super cool blanco	Super cool bianco	Super cool blanc	
GS90024	Tohatsu Grey Metal (1991)	Gris Metal (1991)	Grigio Metallizzato (1991)	Gris Métallisé (1991)	
GS90027	Tohatsu Blue Cobalt (1988-90)	Azul Cobalto (1988-90)	Blu Cobalto (1988-90)	Bleu Cobalt (1988-90)	
GS90043	Tohatsu Blue aquamarine	Azul aquamarine	Blu aquamarine	Bleu aquamarine	
GS90073	Vetus Yellow	Amarillo	Giallo	Jaune	
GS90064	Volvo Grey (1995)	Gris (1995)	Grigio (1995)	Gris (1995)	
GS90034	Volvo Grey Aquamatic	Gris Aquamatic	Grigio Aquamatic	Gris Aquamatic	
GS90005	Volvo Red (1972+)	Rojo (1972+)	Rosso (1972+)	Rouge (1972+)	
GS90007	Volvo Green water (1972+)	Verde agua (1972+)	Verde acqua (1972+)	Vert (1972+)	
GS90029	Volvo Grey (1989)	Gris (1989)	Grigio (1989)	Gris (1989)	
GS90003	Volvo Grey Metal SX/DPX	Gris metalizado SX/DPX	Grigio metallizzato SX/DPX	Gris métallisé SX/DPX	
GS90004	Yanmar Grey Metal (1987+)	Gris metalizado (1987+)	Grigio metallizzato (1987+)	Gris métallisé (1987+)	
GS90021	Yamaha Blue Metal (1974)	Azul Metal (1974)	Blu Metallizzato (1974)	Bleu Métallisé (1974)	
GS90020	Yamaha Blue Origen	Azul Origen	Blue Origen	Bleu Origine	
GS90022	Yamaha Grey Metal (1994)	Gris Metal (1994)	Grigio Metallizzato (1994)	Gris Métallisé (1994)	
GS90066	Yamaha Pearl white base paint	Pintura base blanca perla	Pittura base bianca perla	Peinture base blanc perle	
GS90067	Yamaha Pearl coat paint	Pintura perla capa	Pittura perla capa	Peinture perle couche	
GS90015	SS.	Inox.	Inox.	Inox.	



## PERMATEX

## HIGH TEMPERATURE GASKET SEALANT

- Fast drying copper sealant that helps dissipate heat, prevents joints from heating up and improves heat transfer.
- Resists all types of fluids.
- Applications: cylinder head gaskets, exhaust manifold gaskets, turbochargers.

REF



PER35580

331 ml

## PERMATEX

## SELLADOR DE JUNTAS DE ALTA TEMPERATURA

- Sellador de cobre de secado rápido que ayuda a disipar el calor, previene el calentamiento de las juntas y mejora la transferencia de calor.
- Resiste todo tipo de fluidos.
- Aplicaciones: juntas de culata, juntas de colector de escape, turbocompresores.

## PERMATEX

## SIGILLANTE PER GIUNTI AD ALTA TEMPERATURA

- Sigillante per rame a rapida essiccazione che aiuta a dissipare il calore, impedisce il riscaldamento dei giunti e migliora il trasferimento del calore.
- Resiste a tutti i tipi di fluidi.
- Applicazioni: guarnizioni della testa del cilindro, guarnizioni del collettore di scarico, turbocompressori.

## PERMATEX

## JOINT D'ÉTANCHÉITÉ HAUTE TEMPÉRATURE

- Produit d'étanchéité en cuivre à séchage rapide qui aide à dissiper la chaleur, empêche les joints de chauffer et améliore le transfert de chaleur.
- Résiste à tous les types de fluides.
- Applications : joints de culasse, joints de collecteur d'échappement, turbocompresseurs.



## GASKET CEMENT

- Air-drying sealant with high adhesion power.
- Remains flexible without cracking under vibration and temperature changes.
- Resistant to petrol, oil and coolants.

REF



PER35572

-54°C--&gt; 204°C

118 ml

## SELLADOR DE JUNTAS

- Producto sellante de secado al aire con gran poder de adhesión.
- Permanece flexible sin agrietarse en vibraciones y cambios de temperatura.
- Resistente a la gasolina, el aceite y refrigerantes.

## SIGILLATORE GUARNIZIONE

- Sigillante che asciuga all'aria con un elevato potere di adesione.
- Rimane flessibile senza incrinarsi in presenza di vibrazioni e sbalzi di temperatura.
- Resistente a benzina, olio e refrigeranti.

## JOINT SEALANT

- Scellant séchant à l'air avec un pouvoir d'adhésion élevé.
- Reste flexible sans se fissurer sous l'effet des vibrations et des changements de température.
- Résistant à l'essence, à l'huile et aux liquides de refroidissement.



## ADHESIVES

- Prevents loosening caused by vibrations.
- Protects the thread from corrosion.

REF



PER35375

-54°C-&gt;149°C

50 ml

PER35395

HEAVY DUTY FIXER RED  
Removable with heat and special tools.

MEDIUM-STRENGTH FIXER BLUE  
Can be removed with hand tools.

FIJADOR ALTA RESISTENCIA ROJO  
Desmontable con calor y herramientas especiales.

FIJADOR MEDIA RESISTENCIA AZUL  
Desmontable con herramientas manuales.

FISSATORE PER IMPIEGHI GRAVOSI ROSSO  
Rimuovibile con calore e strumenti speciali.

BLU FISSATIVO A MEDIA RESISTENZA  
Può essere rimosso con attrezzi manual.

FIXATEUR POUR TRAVAUX LOURDS ROUGE  
Démontable à la chaleur et avec des outils spéciaux.

BLEU FIXATEUR DE FORCE MOYENNE  
Peut être retiré avec des outils manuels.



## GRINDING FOR WATER-OPERATED VALVES

REF



PER12073

100 ml

## ESMERIL PARA VÁLVULAS AL AGUA

Coarse grain

## SMERIGLIATRICE PER VALVOLE DELL'ACQUA

Grano grueso

Grana grossa

## PATE A RODER POUR SOUPAPES

Grain grossier

PER12063

100 ml

Fine grain

Grano fino

Grano fino

Grain fin



## FAST BREAK

- Penetrant and graphitized lubricant for easy loosening, sliding or unscrewing of all kinds of parts seized by rust or dirt.
- Facilitates subsequent disassembly.

REF



PER35611

400 ml

## AFLOJATODO

- Penetrante y lubricante grafitado para soltar, deslizar o desenroscar con facilidad toda clase de piezas agarrotadas.
- Facilita el posterior desmontaje.

## ALLENATA TUTTO

- Penetrante e lubrificante grafitizzato per facilitare l'allentamento, lo scorrimento o lo svitamento di tutti i tipi di parti bloccate
- Facilita lo smontaggio successivo.

## LIBÈRE TOUT

- Lubrifiant pénétrant et graphité pour faciliter le desserrage, le glissement ou le dévissage de toutes sortes de pièces grippées.
- Facilite le démontage ultérieur.



**TERCLEN ENGINE CLEANER**

- For cleaning all kinds of engines, mechanical parts, garage floors, etc.
- Does not attack paint, rubber or engine plastics.

REF



PER37243 400 ml

**LIMPIA MOTORES TERCLEN**

- Para limpiar toda clase de motores, piezas mecánicas, suelos de garajes, etc.
- No ataca la pintura, gomas o plásticos de motor.

**PULIZIA DI MOTORI TERCLEN**

- Per la pulizia di tutti i tipi di motori, parti meccaniche, pavimenti di garage, ecc.
- Non attacca la vernice, la gomma o le plastiche del motore.

**NETTOYANT MOTEUR TERCLEN**

- Pour le nettoyage de toutes sortes de moteurs, de pièces mécaniques, de sols de garage, etc.
- N'attaque pas la peinture, le caoutchouc ou les plastiques du moteur.



**TURBO CLEANER SPRAY**

- Wynn's Turbo Cleaner cleans and frees the variable geometry and turbine surfaces of turbos clogged by accumulated contamination.
- When sprayed, it produces a foam that has a long-lasting cleaning effect on the turbo surface.

REF



PER18693 200 ml

**LIMPIADOR TURBO SPRAY**

- Wynn's Turbo Cleaner limpia y libera la geometría variable y la turbina de los turbos atascados por contaminación acumulada.
- Al pulverizarlo, produce una espuma que tiene un efecto de limpieza duradero en la superficie del turbo.

**SPRAY PULITORE TURBO**

- Il detergente per turbocompressori Wynn's pulisce e libera le superfici a geometria variabile e le turbine dei turbocompressori ostruite da contaminazioni accumulate.
- Spruzzato, produce una schiuma che pulisce a lungo la superficie del turbocompressore.

**SPRAY NETTOYANT TURBO**

- Le nettoyant Wynn's Turbo Cleaner nettoie et libère les surfaces à géométrie variable et les surfaces de turbine des turbos obstruées par des impuretés accumulées.
- Une fois pulvérisé, il produit une mousse qui nettoie durablement la surface du turbo.



**TURBO CLEANER**

- Wynn's Diesel Turbo Cleaner is a chemical treatment that cleans blocked diesel turbochargers.

REF



PER75003 500ml

**LIMPIADOR TURBO LIQUIDO**

- Wynn's Diesel Turbo Cleaner es un tratamiento químico que limpia los turbocompresores diésel bloqueados.

**PULITORE TURBO**

- Wynn's Diesel Turbo Cleaner è un trattamento chimico che pulisce i turbocompressori diesel bloccati.

**NETTOYANT TURBO**

- Wynn's Diesel Turbo Cleaner est un traitement chimique qui nettoie les turbocompresseurs diesel bloqués.



**VALVE CLEANER SPRAY**

- Powerful foam cleaner to remove hardened carbon and other contamination from the air intake system, intake valves, valve seats and combustion chamber quickly restoring proper engine performance.

REF



PER18673 500 ml

**LIMPIADOR VALVULAS SPRAY**

- Potente limpiador de espuma para eliminar el carbono endurecido y otra contaminación del sistema de admisión de aire, las válvulas de entrada, los asientos de las válvulas y la cámara de combustión restaurando rápidamente el rendimiento correcto del motor.

**SPRAY PULITORE VALVOLE**

- Potente detergente in schiuma per rimuovere il carbonio indurito e altre contaminazioni dal sistema di aspirazione dell'aria, dalle valvole di aspirazione, dalle sedi delle valvole e dalla camera di combustione, ripristinando rapidamente le prestazioni del motore.

**SPRAY NETTOYANT POUR VALVES**

- Mousse nettoyante puissante pour éliminer le carbone durci et d'autres contaminations du système d'admission d'air, des soupapes d'admission, des sièges de soupapes et de la chambre de combustion, afin de rétablir rapidement les performances du moteur.



**WATER REPELLENT**

- Invisible treatment that creates an invisible hydrophobic layer that repels rain, sleet and snow.

REF



PER26011 200 ml

**REPELENTE AGUA**

- Tratamiento invisible que crea una capa hidrofóbica invisible que repele la lluvia, aguanieve y nieve.

**IDROREPELENTE**

- Trattamento invisibile che crea uno strato idrofobico invisibile che respinge pioggia, nevischio e neve.

**HYDROPHOBES**

- Traitement invisible qui crée une couche hydrophobe invisible qui repousse la pluie, le grésil et la neige.



**LITHIUM GREASE WITH TEFLON**

REF



PER35621 350 ml

**GRASA DE LITIO CON TEFLON**

**GRASSO AL LITIO CON TEFLON**

**GRAISSE AU LITHIUM AVEC DU TEFLON**



GASKET MAKER

FORMADORES DE JUNTAS

FORMATORI GUARNIZIONE

FORMA JOINTS

1



2



3



SILKRON							
1	PER54291	-60°C--> 220°C	75 ml	<ul style="list-style-type: none"> <li>- Single-component acetic silicone.</li> <li>- Resistant to oil and high temperatures.</li> <li>- Can be easily removed during disassembly or repair.</li> </ul>	<ul style="list-style-type: none"> <li>- Silicona acética monocomponente.</li> <li>- Resistente al aceite y altas temperaturas.</li> <li>- Puede eliminarse fácilmente en desmontaje o reparación</li> </ul>	<ul style="list-style-type: none"> <li>- Silicone acetico monocomponente.</li> <li>- Resistente all'olio e alle alte temperature.</li> <li>- Può essere facilmente rimosso durante lo smontaggio o la riparazione.</li> </ul>	<ul style="list-style-type: none"> <li>- Silicone acétique monocomposant.</li> <li>- Résistant à l'huile et aux températures élevées.</li> <li>- Peut être facilement retiré lors du démontage ou de la réparation.</li> </ul>
2	PER54292		200 ml	<ul style="list-style-type: none"> <li>- Silicone sealant for in-situ jointing with oil and high temperature resistance characteristics.</li> </ul>	<ul style="list-style-type: none"> <li>- Sellador de silicona para la formación de juntas "in situ" con características de resistencia al aceite y altas temperaturas.</li> </ul>	<ul style="list-style-type: none"> <li>- Sigillante siliconico per giunzioni in situ con caratteristiche di resistenza all'olio e alle alte temperature.</li> </ul>	<ul style="list-style-type: none"> <li>- Mastic silicone pour le jointoement in-situ avec des caractéristiques de résistance à l'huile et aux hautes températures.</li> </ul>
3	PER54283	-60°C--> 300°C	300 ml				

SUPRA							
1	PER35124	-70°C--> 260°C	80 ml	<p><b>MAXIMUM OIL RESISTANCE</b></p> <ul style="list-style-type: none"> <li>- Sealant with outstanding oil resistance, fast curing, low odour, non-corrosive, non-damaging to oxygen sensors.</li> <li>- High flexibility due to patented adhesion system.</li> <li>- Resistant to fluids and vibrations.</li> </ul>	<p><b>MÁXIMA RESISTENCIA AL ACEITE</b></p> <ul style="list-style-type: none"> <li>- Extraordinaria resistencia al aceite, de curado rápido, bajo olor, no corrosivo, no daña sensores de oxígeno.</li> <li>- Alta flexibilidad</li> <li>- Sistema patentado.</li> <li>- Resistencia a los fluidos y vibraciones.</li> </ul>	<p><b>MASSIMA RESISTENZA ALL'OLIO</b></p> <ul style="list-style-type: none"> <li>- Eccezionale resistenza all'olio, a indurimento rapido, a basso odore, non corrosivo, non dannoso per i sensori di ossigeno.</li> <li>- Elevata flessibilità.</li> <li>- Sistema brevettato.</li> <li>- Resistente ai fluidi e alle vibrazioni..</li> </ul>	<p><b>RÉSISTANCE MAXIMALE À L'HUILE</b></p> <ul style="list-style-type: none"> <li>- Une résistance exceptionnelle à l'huile, à durcissement rapide, à faible odeur, non corrosif, n'endommageant pas les sondes à oxygène.</li> <li>- Grande flexibilité</li> <li>- Système breveté.</li> <li>- Résistant aux fluides et aux vibrations.</li> </ul>
2	PER35134	-70°C--> 260°C	80 ml	<p><b>HEAVY DUTY ENGINES</b></p> <ul style="list-style-type: none"> <li>- For high torque applications.</li> <li>- Highly resistant to compression set and high pressures.</li> <li>- Non-corrosive and low odour.</li> <li>- Resistant to fluids, oil and vibration.</li> </ul>	<p><b>MOTORES DE GRAN POTENCIA</b></p> <ul style="list-style-type: none"> <li>- Para aplicaciones de elevado par.</li> <li>- Muy resistente a compresión y altas presiones.</li> <li>- No corrosivo y bajo olor.</li> <li>- Resistente a fluidos, aceite y vibración.</li> </ul>	<p><b>MOTORI PER IMPIEGHI GRAVOSI</b></p> <ul style="list-style-type: none"> <li>- Per applicazioni ad alta coppia di serraggio.</li> <li>- Altamente resistente alla compressione e alle alte pressioni.</li> <li>- Non corrosivo e a basso odore.</li> <li>- Resistente ai fluidi, all'olio e alle vibrazioni.</li> </ul>	<p><b>MOTEURS À USAGE INTENSIF</b></p> <ul style="list-style-type: none"> <li>- Pour les applications à couple élevé.</li> <li>- Hautement résistant à la compression rémanente et aux pressions élevées.</li> <li>- Non corrosif et peu odorant.</li> <li>- Résistant aux fluides, à l'huile et aux vibrations.</li> </ul>
3	PER35144	-70°C--> 350°C	80 ml	<p><b>HIGH TEMPERATURE</b></p> <ul style="list-style-type: none"> <li>- For use in high temperature, high performance, 4 cylinder, turbocharged and high performance engines.</li> <li>- Will not damage oxygen sensors.</li> <li>- Three times more oil resistant than conventional silicones.</li> </ul>	<p><b>ALTA TEMPERATURA</b></p> <ul style="list-style-type: none"> <li>- Para motores que trabajan a gran temperatura, motores de 4 cilindros, turboalimentados y de grandes prestaciones.</li> <li>- No daña sensores de oxígeno.</li> <li>- Tres veces más resistente al aceite que las siliconas convencionales.</li> </ul>	<p><b>ALTA TEMPERATURA</b></p> <ul style="list-style-type: none"> <li>- Per motori ad alta temperatura, a 4 cilindri, turbocompressi e ad alte prestazioni.</li> <li>- Non danneggia i sensori di ossigeno.</li> <li>- Tre volte più resistente agli oli rispetto ai siliconi convenzionali.</li> </ul>	<p><b>TEMPÉRATURE ÉLEVÉE</b></p> <ul style="list-style-type: none"> <li>- Pour être utilisé dans les moteurs à haute température, 4 cylindres, turbocompressés et à haute performance.</li> <li>- N'endommage pas les capteurs d'oxygène.</li> <li>- Trois fois plus résistant à l'huile que les silicones classiques.</li> </ul>

1



2



3



LOCTITE	LOCTITE	LOCTITE	LOCTITE
THREADED FIXER, METHACRYLATE BASED	FIJADOR DE ROSCAS, BASE METACRILATO	FISSATORE DE FILETTATI, BASE DI METACRILATO	FIXATEUR DES DILETÉS, À BASE DE MÉTHACRYLATE
REF 			
<b>LOC242</b> ■ 50 ml MEDIUM	<ul style="list-style-type: none"> <li>- Specially formulated for locking and sealing threaded components up to M36.</li> <li>- Medium strength, medium viscosity.</li> <li>- It provides fast setting times: 5 min on steel, 15 min on brass and 20 min on SS.</li> </ul>	<ul style="list-style-type: none"> <li>- Para fijar y sellar componentes roscados hasta M36.</li> <li>- Resistencia media y viscosidad media.</li> <li>- Tiempos de fijación rápidos: 5 min en acero, 15 min en latón y 20 min en acero inoxidable.</li> </ul>	<ul style="list-style-type: none"> <li>- Appositamente formulato per bloccare e sigillare componenti filettati fino a M36.</li> <li>- Media resistenza e media viscosità</li> <li>- Tempi di presa rapidi: 5 minuti sull'acciaio, 15 minuti sull'ottone e 20 minuti sull'acciaio inox.</li> </ul>
<b>LOC243</b> ■ 50 ml MEDIUM	<ul style="list-style-type: none"> <li>- It is designed to improve oil tolerance with surface insensitive properties (galvanised fasteners no require activator).</li> <li>- Applications: Rocker arm bolts, oil pans, disc brake calipers, pulley assemblies and many more.</li> </ul>	<ul style="list-style-type: none"> <li>- Está diseñado para mejorar la tolerancia al aceite (las fijaciones galvanizadas no requieren activador).</li> <li>- Aplicaciones: pernos de balancin, cárteres de aceite, pinzas de freno de disco, conjuntos de poleas y muchos más.</li> </ul>	<ul style="list-style-type: none"> <li>- È progettato per migliorare la tolleranza all'olio con proprietà insensibili alla superficie (gli elementi di fissaggio zincati non richiedono l'attivatore).</li> <li>- Applicazioni : bulloni dei bilancieri, coppe dell'olio, pinze dei freni a disco, gruppi di pulegge e molto altro.</li> </ul>
<b>LOC2701</b> ■ 50 ml HIGH	<ul style="list-style-type: none"> <li>- Low viscosity.</li> <li>- With a setting time of 10 minutes on steel, 4 minutes on brass and 25 minutes on stainless steel.</li> </ul>	<ul style="list-style-type: none"> <li>- Baja viscosidad.</li> <li>- Con un tiempo de fijación de 10 minutos en acero, 4 minutos en latón y 25 minutos en acero inoxidable.</li> </ul>	<ul style="list-style-type: none"> <li>- Bassa viscosità.</li> <li>- Con un tempo di presa di 10 minuti sull'acciaio, 4 minuti sull'ottone e 25 minuti sull'acciaio inox.</li> </ul>



INSTANT ADHESIVE	ADHESIVO INSTANTÁNEO	ADESIVO Istantaneo	ADHESIF INSTANTANE
<ul style="list-style-type: none"> <li>- For bonding metal to metal, rubber or magnets, particularly in wet environments.</li> </ul>	<ul style="list-style-type: none"> <li>- Para unir metal con metal, con caucho o con imanes, particularmente en entornos húmedos.</li> </ul>	<ul style="list-style-type: none"> <li>- Per l'incollaggio di metallo su metallo, gomma o magneti, in particolare in ambienti umidi.</li> </ul>	<ul style="list-style-type: none"> <li>- Pour coller du métal sur du métal, du caoutchouc ou des aimants, en particulier dans les environnements humides.</li> </ul>

REF 
<b>LOC480</b> 20 g



THREAD SEALER GENERAL USE	SELLADOR DE ROSCAS USO GENERAL	SIGILLANTE PER FILETTI USO GENERALE	SCCELLANT POUR FILETS À USAGE GÉNÉRAL
<ul style="list-style-type: none"> <li>- Medium-strength, general purpose thread sealant for parallel/parallel and parallel/conical joints.</li> <li>- It fills the space between threaded parts, seals and clamps at the same time.</li> <li>- Is designed for fastening and sealing metal pipe and threaded metal fittings.</li> </ul>	<ul style="list-style-type: none"> <li>- Sellador de resistencia media, de uso general para uniones paralela/paralela y paralela/cónica.</li> <li>- Rellena el espacio entre las piezas roscadas, sella y fija al mismo tiempo.</li> <li>- Está diseñado para fijar y sellar tuberías de metal, así como conexiones metálicas roscadas.</li> </ul>	<ul style="list-style-type: none"> <li>- Sigillante a media resistenza, di uso generale, per giunzioni parallele/parallele e parallele/coniche.</li> <li>- Riempi lo spazio tra le parti filettate, sigilla e fissa allo stesso tempo.</li> <li>- È progettato per il fissaggio e la sigillatura di tubi metallici e di connessioni metalliche filettate.</li> </ul>	<ul style="list-style-type: none"> <li>- Produit d'étanchéité pour filetage de force moyenne, à usage général, pour les joints parallèles/parallèles et parallèles/coniques.</li> <li>- Il remplit l'espace entre les pièces filetées, assure l'étanchéité et la fixation en même temps.</li> <li>- Il est conçu pour la fixation et l'étanchéité des tuyaux métalliques et des raccords métalliques filetés.</li> </ul>

REF 
<b>LOC577</b> 50 ml



ICE EFFECT FLOATING TAP (-40°C)	AFLOJADOR EFECTO HIELO (-40°C)	RILASCIATORE DI GOCCIA EFFETTO GHIACCIO (-40°C)	EFFET GLACE RELIEVER (-40°C)
<ul style="list-style-type: none"> <li>- It is a special mineral oil designed to free rusted, corroded and seized parts.</li> <li>- The product suddenly cools the treated parts down to -43 °C and causes microscopic cracks in the rust layer. This allows the lubricant to seep directly into the oxide layer by capillary action.</li> <li>- Once released, the parts remain lubricated and protected against corrosion.</li> </ul>	<ul style="list-style-type: none"> <li>- Aceite mineral especial diseñado para liberar piezas oxidadas, corroidas y agarradas.</li> <li>- El producto enfría súbitamente las piezas tratadas hasta -43 °C y causa grietas microscópicas en la capa de óxido. Esto permite que el lubricante se filtre.</li> <li>- Una vez sueltas, las piezas siguen estando lubricadas y protegidas contra la corrosión.</li> </ul>	<ul style="list-style-type: none"> <li>- Olio minerale progettato per liberare i pezzi arrugginiti, corrosi e grippati.</li> <li>- Il prodotto raffredda improvvisamente le parti trattate fino a -43°C e provoca microscopiche crepe nello strato di ruggine. Ciò consente al lubrificante di penetrare per capillarità direttamente nello strato di ossido.</li> <li>- Una volta rilasciati, i pezzi rimangono lubrificati e protetti dalla corrosione.</li> </ul>	<ul style="list-style-type: none"> <li>- Il est une huile minérale spéciale conçue pour dégager les pièces rouillées, corrodées et grippées.</li> <li>- Le produit refroidit brutalement les pièces traitées jusqu'à -43°C et provoque des fissures microscopiques dans la couche de rouille. Cela permet au lubrifiant de s'infiltrer par capillarité directement dans la couche d'oxyde.</li> <li>- Une fois libérées, les pièces restent lubrifiées et protégées contre la corrosion.</li> </ul>

REF 
<b>LOC8040</b> 400 ml



**CONTACT CLEANER**

- Ideal for cleaning electrical contacts exposed to moisture or other contamination.

**LIMPIADOR DE CONTACTOS**

- Ideal para limpiar contactos eléctricos expuestos a la humedad u otros tipos de contaminación.

**PULITORE PER CONTATTI**

- Ideale per pulire i contatti elettrici esposti all'umidità o ad altre contaminazioni.

**NETTOYEUR DE CONTACT**

- Idéal pour nettoyer les contacts électriques exposés à l'humidité ou à d'autres contaminations.

REF		
LOC7039	400 ml	-30°C --> +50°C

**SEAL REMOVER**

- Removes residues of all types of gaskets and chemical engine sealants, as well as dried oil, tar, soot and paint residues in 10-15 minutes.  
- Particularly suitable for aluminium or other soft metal flanges where the surfaces of the parts to be cleaned could be damaged.

**QUITAJUNTAS**

- Elimina restos de todo tipo de juntas y selladores químicos para el motor, así como restos secos de aceite, alquitrán, hollín y pintura en 10-15 minutos.  
- Particularmente indicado para bridas de aluminio u otros metales blandos donde las superficies de las piezas a limpiar podrían dañarse.

**PULITORE PER GUARNIZIONI**

- Rimuove i residui di tutti i tipi di guarnizioni e sigillanti chimici per motori, nonché olio secco, catrame, fuliggine e residui di vernice in 10-15 minuti.  
- Particolarmente indicato per le flange in alluminio o in altri metalli morbidi, dove le superfici delle parti da pulire potrebbero essere danneggiate.

**NETTOYEUR DE JOINT**

- Élimine les résidus de tous les types de joints et de produits d'étanchéité chimiques pour moteurs, ainsi que l'huile séchée, le goudron, la suie et les résidus de peinture en 10-15 minutes.  
- Particulièrement adapté aux brides en aluminium ou autres métaux tendres où les surfaces des pièces à nettoyer risquent d'être endommagées.

REF	
LOC7200	400 ml

**JOINT REINFORCER NO. 2**

- A flexible sealing paste that transforms into a malleable film that does not harden through solvent evaporation, used for sealing flanges, fasteners, fittings, etc.  
- For gaskets made of cork, metal, plastic, rubber, etc. in non-rigid assemblies. Flexible fit.

**REFORZADOR DE JUNTAS Nº 2**

- Pasta selladora flexible que se transforma en una película maleable que no se endurece a través de la evaporación del disolvente, empleada para sellar bridas, fijaciones, conexiones, etc.  
- Para juntas preformadas hechas de corcho, metal, plástico, caucho, etc. en montajes no rígidos.

**RINFORZANTE PER GIUNTI Nº 2**

- Pasta sigillante flessibile che si trasforma in una pellicola malleabile che non indurisce per evaporazione del solvente, utilizzata per sigillare flange, elementi di fissaggio, connessioni, ecc.  
- Per guarnizioni preformate in sughero, metallo, plastica, gomma, ecc. in assemblaggi non rigidi.

**RENFORCEUR D'ARTICULATION Nº 2**

- Pâte d'étanchéité flexible qui se transforme en un film malleable qui ne durcit pas par évaporation du solvant, utilisée pour l'étanchéité des brides, des fixations, des raccords, etc.  
- Pour liège, métal, plastique, caoutchouc, etc. dans les assemblages non rigides. Ajustement souple.

REF	
LOC5922	200 ml

**SEALING TAPE RED**

- Self-vulcanizing tape for temporary repairs on flexible pipes and hoses.  
- Electrical resistance of up to 15 kV/mm.  
- Resists UV radiation and contact with oils, salts, corrosive chemicals, etc.

**CINTA AISLANTE**



- Cinta autovulcanizante para reparaciones temporales en tuberías flexibles y mangueras.  
- Resistencia eléctrica de hasta 15 kV/mm.  
- Resiste a la radiación UV y al contacto con aceites, sales, químicos corrosivos, etc.

**NASTRO ISOLANTE**

- Nastro autovulcanizzante per riparazioni temporanee di tubi flessibili.  
- Resistenza elettrica fino a 15 kV/mm.  
- Resistente ai raggi UV e al contatto con oli, sali, sostanze chimiche corrosive, ec.

**BANDE ISOLANTE**

- Ruban auto-vulcanisant pour les réparations temporaires sur les tuyaux flexibles.  
- Résistance électrique jusqu'à 15 kV/mm.  
- Résiste aux rayons UV et au contact avec les huiles, les sels, les produits chimiques corrosifs, etc.

REF		
LOC5075	4,27 m x 2,5 cm	-54°C --> +260°C

**PIPE SEALING THREAD**

- Immediately seals against pipe working pressure.  
- Allows reliable joint reseating.  
- Is designed to set and seal metal and plastic pipe and threaded fittings.

**HILO SELLADOR DE TUBERÍAS**

- Sella de forma inmediata ante la presión de trabajo de la tubería.  
- Permite reajustes fiables de la unión.  
- Diseñado para fijar y sellar tuberías y conexiones roscadas metálicas y plásticas.

**FILO DI SIGILLATURA PER TUBI**

- Sigilla immediatamente sotto la pressione di esercizio del tubo.  
- Consente un serraggio affidabile del giunto.  
- E progettato per fissare e sigillare tubi e raccordi filettati in metallo e plastica.

**FIL D'ÉTANCHÉITÉ POUR TUYAU**

- Scelle immédiatement sous la pression de service du tuyau.  
- Permet un resserrage fiable du joint.  
- Il est conçu pour fixer et étancher les tuyaux et raccords filetés en métal et en plastique.

REF	
LOC55	160 ml

**HAND CLEANING PASTE**

- It removes dirt, oil and grease without aggressive solvents.

**PASTA LIMPIA MANOS**

- Elimina la suciedad, el aceite y la grasa sin solventes agresivos.

**PASTA PULIZIA MANO**

- Rimuove sporco, olio e grasso senza solventi aggressivi.

**PATE DE NETTOYAGE DES MAINS**

- Elle élimine la saleté, l'huile et la graisse sans solvants agressifs.

REF	
TER320	8,5 kg





10

STEERING SYSTEM

MECHANICAL STEERING

- It has the feature of ZTS (zero torque system) built onto the helm.

REF		
PRE260304	ZTS NLT 2500xx	-50HP
PRE260303	NLT ROTARY 1900	

ZERO TORQUE STEERING ROTARY HELM  
 - Eliminates prop feedback load.  
 - Precise response of 3.8 turns lock-to-lock.

SISTEMA DE GOBIERNO

DIRECCIÓN MECÁNICA

- Con mecanismo antiretorno.  
 - Nuevo casco giratorio ZTS NLT.  
 - ZTS (sistema de par cero) integrado en el timón.



CAJA DE DIRECCIÓN AJUSTABLE ZTS  
 - Con mecanismo antiretorno.  
 - Elimina el «feedback» de la hélice.  
 - N° vueltas babor-estribor: 3,8.

SISTEMA DI TIMONERIA

TIMONERIA MECCANICA

- Con meccanismo di non ritorno  
 - Sistema ZTS (zero torque system) integrato nel timone.



TIMONERIA ZTS  
 - Con meccanismo anti-ritorno.  
 - Elimina il feedback delle eliche.  
 - N° giri destra e sinistra: 3,8.

SYSTÈME DIRECTION

DIRECTION MÉCANIQUE

- Il possède la fonctionnalité ZTS (système à couple nul) intégré à la barre.



BOÎTIER DE DIRECTION ZTS  
 - Avec mécanisme anti-retour.  
 - Élimine le «retour» de l'hélice.  
 - Nombre de tours bâbord-tribord: 3,8.

REF						
PRE500010	Helm	Caja de dirección	Timoneria	Boitier de direction		Teleflex-Morse®
PRE500012	Bezel kit 90°	Ménsula de montaje 90°	Coprimozzo 90°	Support incliné 90°	3000 SS	NFB Safe-T II
PRE500014	Bezel kit 20°	Ménsula de montaje 20°	Coprimozzo 20°	Support incliné 20°		NFB 4.2 T73BRFC



- With full 40 degree range of motion.

- Sistema de ángulo ajustable hasta 40°.  
 - Se acomoda la postura de conducción más idónea para el piloto.

- Sistema di angolo fino a 40°.  
 - Si può impostare la posizione più idonea di guida per il pilota.

- Système d'angle réglable jusqu'à 40°.  
 - Permet d'obtenir la position de conduite la plus appropriée pour le pilote.

REF	
PRE500007	ZTS
PRE370987	3000



KIT LT

- Rotary steering system: Helm, Steering cable and 90° bezel.  
 - 2,5 turns lock to lock. T  
 - Travel 230 mm.

KIT LT





- Compuesto por 1 caja operadora, 1 cable de dirección según las medidas indicadas y un bisel de montaje de 90°.  
 - Carrera del cable 230 mm con 2,5 vueltas de volante

KIT LT

- Composto da una timoneria, 1 cavo timoneria secondo le dimensioni indicate e una piastra da 90°.  
 - Corsa cavo 230mm con 2,5 giri del volante.

KIT LT

- Composé d'un boîtier de commande, d'un câble de direction selon les mesures indiquées et d'un support incliné à 90°.  
 - Course du câble 230 mm avec 2,5 tours de volant

REF				
PRE208005	5' / 1,50 m			
PRE208006	6' / 1,80 m			
PRE208007	7' / 2,10 m			
PRE208008	8' / 2,45 m			
PRE208009	9' / 2,75 m			
PRE208010	10' / 3,05 m	5,5 m	55 hp	360°
PRE208011	11' / 3,35 m			
PRE208012	12' / 3,65 m			
PRE208013	13' / 3,95 m			
PRE208014	14' / 4,25 m			
PRE208015	15' / 4,60 m			
PRE208016	16' / 4,90 m			



**KIT 3000 SS**

- Rotary steering system: Helm, Stainless Steel Cable and 90° Bezel.
- Stainless steel inner cable with spring stainless steel enclosure coil.
- Maximun working load: 300 lb at the tiller arm.
- Three turns lock to lock. Travel 230 mm.

**KIT 3000 SS**

- Compuesto por 1 caja operadora, 1 cable de dirección fabricado en acero inox según medidas indicadas y un bisel de montaje de 90°.
- Para embarcaciones con un esfuerzo máximo de 140 kg en el punto de unión.
- Puede montarse en cualquier posición con movimientos de 90°.
- Carrera del cable 230 mm con 3,6 vueltas de volante.

**KIT 3000 SS**

- Composto da una timoneria, 1 cavo timoneria in acciaio inox, secondo le misure richieste e una piastra di montaggio di 90°.
- Per imbarcazioni con uno sforzo massimo di 140kg nel punto di unione.
- Si può montare in qualunque posizione con un movimento di 90°.
- Corsa del cavo 230mm con 3,6 giri del volante.

**KIT 3000 SS**

- Composé de 1 boîtier de commande, 1 câble de direction en acier inoxydable selon les mesures indiquées et un support incliné à 90°.
- Pour les bateaux avec un effort maximum de 140 kg au point de jonction.
- Course du câbles 230 mm avec 3,6 tours de volant

REF			
PRE315008	8' / 2,45 m	8 m	200 mm
PRE315009	9' / 2,75 m		
PRE315010	10' / 3,05 m		
PRE315011	11' / 3,35 m		
PRE315012	12' / 3,65 m		
PRE315013	13' / 3,95 m		
PRE315014	14' / 4,25 m		
PRE315015	15' / 4,60 m		
PRE315016	16' / 4,90 m		
PRE315017	17' / 5,20 m		
PRE315018	18' / 5,50 m		
PRE315019	19' / 5,80 m		
PRE315020	20' / 6,10 m		

Teleflex-Morse®  
Safe-T QC  
Safe-T  
Uflex T71FC



**STEERING CABLE**

**CABLES DE DIRECCIÓN**

**CAVO DI TIMONERIA**

**CÂBLES DE DIRECTION**

REF		REF	
PRE250005	5' / 1,50 m	PRE250011	11' / 3,35 m
PRE250006	6' / 1,80 m	PRE250012	12' / 3,65 m
PRE250007	7' / 2,10 m	PRE250013	13' / 3,95 m
PRE250008	8' / 2,45 m	PRE250014	14' / 4,25 m
PRE250009	9' / 2,75 m	PRE250015	15' / 4,60 m
PRE250010	10' / 3,05 m	PRE250016	16' / 4,90 m
PRE550008	8' / 2,45 m	PRE550018	18' / 5,50 m
PRE550009	9' / 2,75 m	PRE550019	19' / 5,80 m
PRE550010	10' / 3,05 m	PRE550020	20' / 6,10 m
PRE550011	11' / 3,35 m	PRE550021	21' / 6,40 m
PRE550012	12' / 3,65 m	PRE550022	22' / 6,70 m
PRE550013	13' / 3,95 m	PRE550023	23' / 7,00 m
PRE550014	14' / 4,25 m	PRE550024	24' / 7,30 m
PRE550015	15' / 4,60 m	PRE550025	25' / 7,60 m
PRE550016	16' / 4,90 m	PRE550026	26' / 7,90 m
PRE550017	17' / 5,20 m		
PRE509007	7' / 2,14 m	PRE509014	14' / 4,25 m
PRE509008	8' / 2,45 m	PRE509015	15' / 4,60 m
PRE509009	9' / 2,75 m	PRE509016	16' / 4,90 m
PRE509010	10' / 3,05 m	PRE509017	17' / 5,20 m
PRE509011	11' / 3,35 m	PRE509018	18' / 5,50 m
PRE509012	12' / 3,65 m	PRE509019	19' / 5,80 m
PRE509013	13' / 3,95 m	PRE509020	20' / 6,10 m

LT

300 SS INOX

MEGA-UR

Ultraflex T71FC, T72FC, T73NR FC, T81FC, T82FC, T83NR FC  
Teleflex Safe-T QC  
NFB 4.2  
NFB Safe-T II



**ACCESSORIES FOR STEERING SYSTEM**

**ACCESORIOS DIRECCIÓN MECÁNICA**

**ACCESSORI PER TIMONERIA MECCANICA**

**ACCESSOIRES POUR DIRECTION MÉCANIQUE**

REF				
1 PRE370618	Swivel joint for steering cables.	Cardan de unión del cable de dirección al motor.	Per unire cavi timoneria al motore.	Union cardan du câble de direction au moteur.
2 PRE370046	Bracket kit for inboard transom steering mount.	Soporte para cable de dirección. Para montaje en el espejo de popa	Supporto per cavi timoneria. Per il montaggio nello specchio di poppa.	Support pour câble de direction. Pour montage sur le tableau AR
3 PRE370613	Bracket kit for inboard side splashwell steering mount.	Soporte para cable de dirección. Para montaje estanco en los laterales de la embarcación. Regulable.	Supporto per cavi timoneria. Montaggio della flangia ai lati dell'imbarcazione. Regolabile.	Support pour câble de direction. Pour un montage étanche sur les côtés du bateau. Réglable.
4 PRE370619	Ball joint for steering cables.	Rótula para unión rápida del cable de dirección al motor.	Giunto per unire i cavi timoneria al motore.	Rotule pour une connexion rapide du câble de direction au moteur.
5 PRE370621	Link arm for outboards steerings.	Barra de reenvío para conexión de los cables de dirección. Fabricada en acero inox. Reforzada.	Barra di direzione per collegare i cavi. In acciaio inox. Rinforzata.	Barre de renvoi pour connecter les câbles de direction. Fabriqué en acier inoxydable. Renforcé



HYDRAULICS STEERING SYSTEM		DIRECCIÓN HIDRÁULICA	TIMONERIA IDRAULICA	DIRECTION HYDRAULIQUE
REF				
1	RECHSOB90 90 HP			
	RECHSOB150 150 HP			
2	RECHSPB250 250 HP			
	RECHSOB350 350 HP			
REF				
RECHSOB90	RECHH18C	RECHC8114	RECHT4430	
RECHSOB150	RECHH20C	RECHC9416	RECHT4431	
RECHSPB250	RECHH25C	RECHC1322	RECHT4432	
RECHSOB350	RECHH28C	RECHC1402	RECHT4433	

**RECMAR®**

KIT, 2 ENGINES (HC53...)	KIT 2 MOTORES (HC53...)	KIT 2 MOTORI (HC53...)	KIT 2 MOTEURS (HC53...)
REF			
TELH06003			

**RECMAR®**

HYDRAULICS STEERING SYSTEM		DIRECCIÓN HIDRÁULICA	TIMONERIA IDRAULICA	DIRECTION HYDRAULIQUE
<b>TOURNAMENT 2</b>				
REF	Engine center distance Distancia centro del motor Distanza centrale del motore Distance central du moteur			
TXH06820	635-673mm			
TXH06821	676-744 mm			
TXH06822	747-869 mm			
TXH06823	871-1092 mm			

*SOASTAR®*

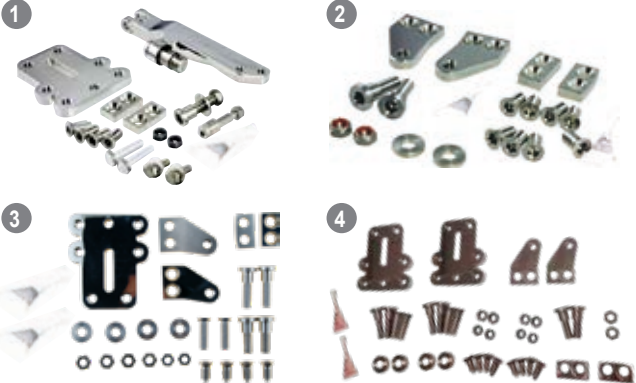
REF		CYLINDERS		
1	TXHA6802	2	1	
2	TXHA6804	2	2	
3	TXHA6806	3	2	
4	TXHA6811	4	2	

**HYDRAULIC KIT**

- Helm pump made in aluminum, with a non-return and pressure relief valves.
- Cylinder in aluminum and stainless steel, with breather valves.
- Completed with racors, rilsan tubing and hydraulic oil.



GS41062

**KIT HIDRAULICO**

- Bomba de aluminio, con válvula antirretorno y sobrepresión.
- Cilindro de aluminio y acero inoxidable, con purgadores.
- Se suministra completa con racors de latón cromado, tubo flexible de rilsan y aceite hidráulico.

**KIT IDRAULICO**

- Corpo pompa in alluminio con valvola anti-ritorno e sovrappresione.
- Cilindro in alluminio e acciaio inox, con spurgo.
- Si vende completa di raccordi in ottone cromato, tubo flessibile e olio idraulico.



GS41065

**KIT HYDRAULIQUE**

- Pompe en aluminium, avec soupape de refoulement et de surpression.
- Vérin en aluminium et acier inoxydable.
- Livré complet avec raccords en laiton chromé, tuyau flexible et huile hydraulique.



GS41066



GS41059

				GS41062 80 hp	GS41065 150 hp	GS41066 300 hp	GS41059 350 hp
Pump model	Modelo bomba	Modello pompa	Modèle de pompe	GM3-MRA	GM0-MRA	GM2-MRA01	GM2-MRA01
helm volume	Capacidad bomba	Cap. Pompa	Capacité de la pompe	14 cm <sup>3</sup>	17 cm <sup>3</sup>	27 cm <sup>3</sup>	27 cm <sup>3</sup>
Cylinder model	Modelo cilindro	Mod. Cilindro	Modèle de vérin	MC90B	MC150BR	MC300A	MC350A
Cylinder volume	Capacidad cilindro	Cap. Cilindro	Cylindrée	75 cm <sup>3</sup>	83 cm <sup>3</sup>	130 cm <sup>3</sup>	140 cm <sup>3</sup>
Cylinder travel	Carrera del pistón	Corsa pistone	Course du vérin	206 mm	200 mm	198 mm	198 mm
Turns lock to lock	Nº vueltas babor-estribor	Nº giri destra e sinistra	No. tours bâbord-tribord	5,2	4,9	4,9	5,2
Hose with racors	Manguera con racors	Tubo con raccordo	Tuyau avec raccords	2 x 5 m	2 x 6 m	2 x 7 m	2 x 7,5 m
Tube Ø	Ø Tubo	Ø Tubo	Ø Tuyau	6,3 mm = 1/4"	6,3 mm = 1/4"	7,94 mm = 5/16"	7,94 mm = 5/16"
CONNECTION KIT	KIT DE CONEXIÓN	KIT DI CONNESSIONE	KIT DE CONNEXION				
	YAMAHA 40/50/60/70 HP, TOHATSU 40/50/60/70 HP			GS41068	GS41068		
	MERCURY MC90B, MC150BR, HONDA 115/130 HP				GS41068		
	SUZUKI 150A/175A					GS41187	GS41187
	MERCURY Optimax 115, MERCURY 150 EFI				GS41069		
	MC300A, MC300B, MC300D					GS41069	
	MC300HD2, MC300HD, MC300BHD					GS41114	
REPAIR KIT	KIT DE REPARACIÓN	KIT DI RIPARAZIONE	KIT DE REPARATION				
				GS41040	GS41041	GS41042	



GS41068



GS41069



GS41114



GS41187



GS41040



GS41041



GS41042



**HYDRAULIC KIT FOR STERN-DRIVES**

- Helm pump made in aluminum with hot pressing processing (not casting), shaft in SS AISI 316, 7 pistons rotor in steel, cylinder in aluminum and SSI, with breather valves.
- Completed with racors, rilsan tubing and 2 L hydraulic oil.

**KIT HIDRAULICO PARA COLAS**

- Bomba de aluminio estampado en caliente, Eje de acero inox AISI 316, rotor de 7 pistones de acero y cilindro de aluminio y acero inox.
- Se suministra completa con racors, 2 x 7,5 m tubo flexible de rilsan y 2 L de aceite hidraulico.

**KIT IDRAULICO PER PIEDI**

- Corpo pompa in alluminio con stampaggio a fusione, asse in acciaio inox AISI316, cilindro a 7 pistoni in acciaio, cilindro in alluminio e acciaio inox.
- Si vende completo di raccordi, 2x7,5 m di tubo flessibile e 2 l di olio idraulico.

**KIT HYDRAULIQUE POUR EMBASES**

- Pompe en aluminium estampé à chaud, Arbre en acier inoxydable AISI 316, rotor à 7 pistons en acier, vérin en aluminium et acier inoxydable.
- Livré complet avec raccords, 2 tuyaux flexibles de 7,5 m et 2 litres d'huile hydraulique.

POWER ASSISTED	SERVO-ASISTIDA	SERVOASSISTITO	ASSISTÉE	GS41053
Model	Modelo	Modello	Dénomination	GF150ET
Pump model	Modelo bomba	Modello pompa	Modèle de pompe	GM2-MRA01
helm volume	Capacidad bomba	Cap. pompa	Capacité de la pompe	27 cm <sup>3</sup>
Cylinder model	Modelo cilindro	Mod. cilindro	Modèle de vérin	MC150
Cylinder volume	Capacidad cilindro	Cap. pompa	Cylindrée	88cm <sup>3</sup>
Cylinder travel	Carrera del pistón	Corsa pistone	Course du vérin	200 mm
Helm weight	Peso bomba	Peso pompa	Poids de la pompe	3 kg
Turns lock to lock	Nº vueltas babor-estribor	Nº giri destra e sinistra	No. tours bâbord-tribord	3,4
Tube Ø	Ø Tubo	Ø Tubo	Ø Tuyau	7,94 mm / 5/16"
Tube length	Longitud tubo	Lungh. tubo	Longueur tuyau	2 x 7,5 m

NOT POWER ASSISTED	SIN SERVO	SENZA SERVO	NON ASSISTÉE	GS41054
Model	Modelo	Modello	Dénomination	GF300BET
Pump model	Modelo bomba	Modello pompa	Modèle de pompe	GM2-MRA03
helm volume	Capacidad bomba	Cap. pompa	Capacité de la pompe	32 cm <sup>3</sup>
Cylinder model	Modelo cilindro	Mod. cilindro	Modèle de vérin	MC300BET
Cylinder volume	Capacidad cilindro	Cap. pompa	Cylindrée	146 cm <sup>3</sup>
Cylinder travel	Carrera del pistón	Corsa pistone	Course du vérin	200 mm
Helm weight	Peso bomba	Peso pompa	Poids de la pompe	3,7 kg
Turns lock to lock	Nº vueltas babor-estribor	Nº giri destra e sinistra	No. tours bâbord-tribord	4,6
Tube Ø	Ø Tubo	Ø Tubo	Ø Tuyau	7,94 mm / 5/16"
Tube length	Longitud tubo	Lungh. tubo	Longueur tuyau	2 x 7,5 m



**ACCESSORIES FOR HYDRAULIC STEERING SYSTEM**

**ACCESORIOS DIRECCIÓN HIDRAULICA**

**ACCESSORI PER TIMONERIA IDRAULICA**

**ACCESSOIRES POUR DIRECTION HYDRAULIQUE**

REF					(mm)
1 GS41080	Link arm for outboards steerings. -Stainless steel.	Barra de dirección para conexión de los cables de dirección. -Acero inox.	Barra di rinvio per la connessione dei cavi timoneria. -Acciaio inox.	Barre de renvoie pour connecter les câbles de direction. -Acier inoxydable.	320 - 340
2 GS41081	Fixed tiller arm	Barra de reenvio	Barre de renvoi	Barra de rinvio	
3 GS41082	Link arm quick connection for outboards steerings. -Stainless steel.	Barra de dirección con conexión rápida para conexión de los cables de dirección. -Acero inox.	Barra di rinvio con connessione rapida per la connessione dei cavi timoneria. -Acciaio inox.	Barre de renvoie avec connexion rapide pour connecter les câbles de direction. -Acier inoxydable.	330 - 370
4 GS41083	Universal tie bar for two engines	Barra de unión para el acople de dos motores	Barra di unione per accoppiamento di due motori.	Barre d'accouplement pour deux moteurs	850
5 GS41084	Universal tie bar with spherical joint for two engines up to 300 hp. -Stainless steel.	Barra de unión con conexión a rótula para 2 motores fueraborda hasta 300 hp. -Acero inox. Aisi 316.	Barra di unione con snofno sferico per due motori fuoribordo fino a 300hp. -Acciaio inox aisi316	Kit barre d'accouplement à rotule pour deux moteurs hors-bord jusqu'à 300 ch. -Acier inoxydable Aisi 316.	640 - 780
6 GS41085	Track rod for 2 engines	Barra acoplamiento 2 motores	Barra di accoppiamento	Barre d'accouplement 2 moteurs	max 62cm
7 GS41035	Stainless steel 316 tie bar for MC300HD/BHD cylinders	Barra de unión de acero inoxidable 316 para cilindros MC300HD/BHD	Barra di collegamento in acciaio inox 316 per cilindri MC300HD/BHD	Barre d'accouplement en acier inoxydable 316 pour vérins MC300HD/BHD	590 - 710
8 GS41037	Oil connection filler tube kit	Kit tubos de llenado aceite	Kit imbarco olio	Kit tubes de remplissage huile	1 x 30 cm 1 x 20 cm
9 GS41188	Short aluminium arms for cylinder MC300A/B/C	Brazos cortos de aluminio para cilindro MC300A/B/C	Bracci corti in alluminio per cilindro MC300A/B/C	Bras courts en aluminium pour cylindre MC300A/B/C	
10 GS41118	Kit cylinder cap	Kit tapones cilindro	Ghiere+guarnizioni	Kit bouchons cylindre	
11 GS41098	Kit hoses (x2) SAE 100 R7	Kit mangueras (x2) SAE 100 R7	Kit tubi (x2) SAE 100 R7	Kit tuyau (x2) SAE 100 R7	5/16" 7,5 m 1/4" 6 m
12 GS41208					



**CYLINDER**

**CILINDRO**

REF	OEM	VOL	STROKE	Ø SHAFT	KIT
GS41077	MC350HD	152 cm <sup>3</sup>	198 mm	20 mm	
GS41060	MC90B	78 cm <sup>3</sup>	200 mm	12 mm	GS41232
GS41063	MC150BR	83 cm <sup>3</sup>	200 mm	16 mm	GS41231
GS41089	MC300A	149 cm <sup>3</sup>	230 mm	18 mm	GS41097
GS41052	MC300BE	146 cm <sup>3</sup>	200 mm	15 mm	GS41038



GS41231

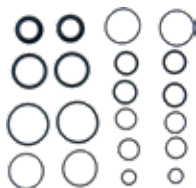

GS41038

**CILINDRO**

**VERIN**

REF	OEM	(mm)						
		A	B	C	D	E	F	G
GS41075	CE50	150	131	107	383	96	44	60
GS41079	CE75	215	187	155	510	130	44	60
GS41179	CE1000	215	187	155	510	130	44	60

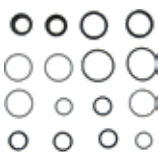
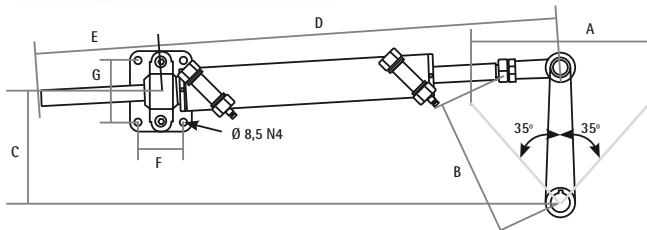

GS41097

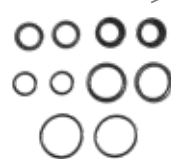

GS41232



**PUMP**

**BOMBA**

REF	OEM	PISTON	Ø MAX.	KG	KIT
GS41070	GM3-MRA	16 cm <sup>3</sup>	7 50 bar	508 mm 20"	2,4 kg GS41039
GS41071	GM0-MRA	17 cm <sup>3</sup>	7 70 bar	508 mm 20"	2,6 kg GS41056 GS41096
GS41072	GM2-MRA01	27 cm <sup>3</sup>	7 70 bar	710 mm 28"	3,4 kg GS41095
GS41073	GM2-MRA03	32 cm <sup>3</sup>	7 70 bar	710 mm 28"	3,4 kg GS41095



GS41095



GS41096

**POMPA**

**POMPE**

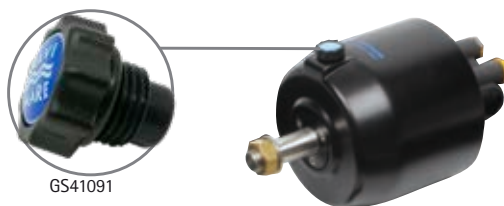

GS41091

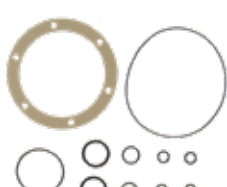

GS41056

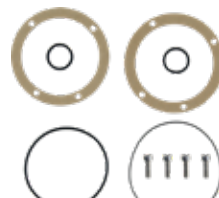

GS41039

**RACOR**

**RACOR**

REF	Ø	Kit
1 GS41047	9/16-24 UNF 5/16"	2
GS41048	9/16-24 UNF 1/4"	2
2 GS41049	9/16-24 UNF 1/4" NPT (90°)	2
3 GS41117	9/16-24 UNF (90°)	2
4 GS41173	9/16-24 UNF	2
5 GS41209	9/16-24 UNF 1/4" NPT (T)	2
6 GS41213	9/16-24 UNF (T)	2
7 GS98011	9/16-24 UNF 1/4" NPT	2
8 GS41220	9/16-24 UNF	2
9 GS41221	9/16-24 UNF	2

**RACCORDO**

**RACCORD**

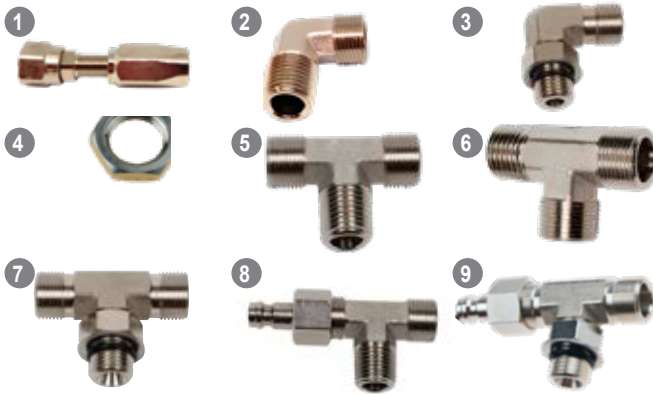

**BY-PASS VALVE IN-LINE MOUNTING**

- It makes possible the short-circuit in the system to execute the manual control in an emergency.
- Fittings not included, order separately: 1 kit GS41209, 2 kit fittings for hoses (GS41047+GS41048).

REF  
GS41207

**VÁLVULA BY-PASS PARA MONTAJE EN LÍNEA**

- Posibilita el cortocircuito en el sistema para ejecutar el control manual en caso de emergencia.
- Accesorios no incluidos. Pedir por separado: 1 kit GS41209, 2 kits de racores para mangueras (GS41047+GS41048).

**VALVOLA BY-PASS PER MONTAGGIO IN LINEA**

- Consente al corto circuito presente nel sistema di eseguire il controllo manuale in caso di emergenza.
- Accessori non inclusi. Ordinare separatamente: 1 kit GS41209, 2 kit raccordi tubo (GS41047+GS41048).

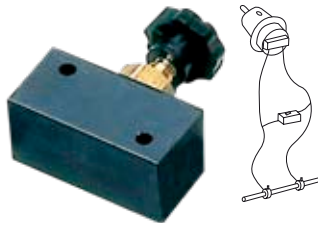

**VANNE DE DÉRIVATION POUR MONTAGE EN LIGNE**

- Il rend possible le court-circuit dans le système pour exécuter la commande manuelle en cas d'urgence.
- Raccords non inclus, à commander séparément : 1 kit GS41209, 2 kits raccords pour durites (GS41047+GS41048).



**OIL FOR HYDRAULIC STEERING SYSTEM**

REF   
GS41074 1 L

**ACEITE PARA DIRECCIÓN HIDRÁULICA**

**OLIO PER TIMONERIA IDRAULICA**

**HUILE POUR DIRECTION HYDRAULIQUE**



**11**



**CONTROL CABLES**

**CABLES DE MANDO**

**CAVI COMANDO**

**CÂBLES DE COMMANDE**

3300C 3300C 3300C 3300C

REF	YAMAHA	SUZUKI	HONDA			TRAVEL
PRE3300C05	YMM-21005-00-00		24911-ZW7-U01	5' / 1,50 m		
PRE3300C06	YMM-21006-C8-00		24912-ZW7-U01	6' / 1,80 m		
PRE3300C07	YMM-21007-C8-00		24913-ZW7-U01	7' / 2,10 m		
PRE3300C08	YMM-21008-C8-00	99105-11002-008	24914-ZW7-U01	8' / 2,45 m		
PRE3300C09	YMM-21009-C8-00	99105-11002-009	24915-ZW7-U01	9' / 2,75 m		
PRE3300C10	YMM-21010-C8-00	99105-11002-010	24916-ZW7-U01	10' / 3,05 m		
PRE3300C11	YMM-21011-C8-00	99105-11002-011	24917-ZW7-U01	11' / 3,35 m		
PRE3300C12	YMM-21012-C8-00	99105-11002-012	24918-ZW7-U01	12' / 3,65 m		
PRE3300C13	YMM-21013-C8-00	99105-11002-013	24919-ZW7-U01	13' / 3,95 m		
PRE3300C14	YMM-21014-C8-00	99105-11002-014	24920-ZW7-U01	14' / 4,25 m		
PRE3300C15	YMM-21015-C8-00	99105-11002-015	24921-ZW7-U01	15' / 4,60 m		
PRE3300C16	YMM-21016-C8-00	99105-11002-016	24922-ZW7-U01	16' / 4,90 m		
PRE3300C17	YMM-21017-C8-00	99105-11002-017	24923-ZW7-U01	17' / 5,20 m		
PRE3300C18	YMM-21018-C8-00	99105-11002-018	24924-ZW7-U01	18' / 5,50 m		
PRE3300C19	YMM-21019-C8-00	99105-11002-019	24925-ZW7-U01	19' / 5,80 m		
PRE3300C20	YMM-21020-C8-00	99105-11002-020	24926-ZW7-U01	20' / 6,10 m		
PRE3300C21	YMM-21021-C8-00	99105-11002-021	24927-ZW7-U01	21' / 6,40 m		
PRE3300C22	YMM-21022-C8-00	99105-11002-022	24928-ZW7-U01	22' / 6,70 m		
PRE3300C23	YMM-21023-C8-00	99105-11002-023	24929-ZW7-U01	23' / 7,00 m		
PRE3300C24	YMM-21024-C8-00	99105-11002-024	24930-ZW7-U01	24' / 7,30 m		
PRE3300C25	YMM-21025-C8-00	99105-11002-025	24931-ZW7-U01	25' / 7,60 m		
PRE3300C26	YMM-21026-C8-00	99105-11002-026	24932-ZW7-U01	26' / 7,90 m		
PRE3300C27	YMM-21027-C8-00	99105-11002-027	24933-ZW7-U01	27' / 8,25 m		
PRE3300C28	YMM-21028-C8-00	99105-11002-028	24934-ZW7-U01	28' / 8,55 m		
PRE3300C29	YMM-21029-C8-00	99105-11002-029	24935-ZW7-U01	29' / 8,85 m		
PRE3300C30	YMM-21030-C8-00	99105-11002-030	24936-ZW7-U01	30' / 9,15 m		
PRE3300C31			24937-ZW7-U01	31' / 9,50 m		
PRE3300C32			24938-ZW7-U01	32' / 9,75 m		
PRE3300C33				33' / 10,00 m		
PRE3300C34				34' / 10,35 m		
PRE3300C35				35' / 10,65 m		
PRE3300C36				36' / 11,00 m		
PRE3300C38				38' / 11,50 m		
PRE3300C40				40' / 12,10 m		
PRE3300C42				42' / 12,70 m		
PRE3300C44				44' / 13,30 m		
PRE3300C46				46' / 14,00 m		
PRE3300C48				48' / 14,50 m		
PRE3300C50				50' / 15,00 m		



10-32" 3" / 76 mm

maxflex

pretech

**4300C - HEAVY DUTY**

**4300C - TRABAJOS PESADOS**

**4300C - LAVORI PESANTI**

**4300C - TRAVAUX LOURDS**



REF	TRAVEL
PRE6500C05	5' / 1,50 m
PRE6500C06	6' / 1,80 m
PRE6500C07	7' / 2,10 m
PRE6500C08	8' / 2,45 m
PRE6500C09	9' / 2,75 m
PRE6500C10	10' / 3,05 m
PRE6500C12	12' / 3,65 m
PRE6500C14	14' / 4,25 m
PRE6500C16	16' / 4,90 m
PRE6500C18	18' / 5,50 m
PRE6500C19	19' / 5,80 m
PRE6500C21	21' / 6,40 m
PRE6500C23	23' / 7,00 m

1/4-28" 3" 76 mm

REF	TRAVEL
PRE6500C25	25' / 7,60 m
PRE6500C27	27' / 8,25 m
PRE6500C29	29' / 8,85 m
PRE6500C31	31' / 9,50 m
PRE6500C33	33' / 10,00 m
PRE6500C35	35' / 10,65 m
PRE6500C37	37' / 11,28 m
PRE6500C39	39' / 11,89 m
PRE6500C41	41' / 12,56 m
PRE6500C43	43' / 13,11 m
PRE6500C45	45' / 13,71 m
PRE6500C47	47' / 14,33 m

1/4-28" 3" 76 mm

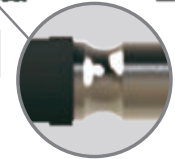

maxflex  
PINNACLE  
pretech

**3300S - DOUBLE COATING**

**3300S - DOBLE FUNDA**

**3300S - DOPPIA GUAINA**

**3300S - DOUBLE GAINE**

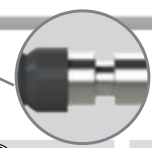

PINNACLE maxflex  
pretech

REF	TRAVEL
PRE6300S05	5' / 1,50 m
PRE6300S06	6' / 1,80 m
PRE6300S07	7' / 2,10 m
PRE6300S08	8' / 2,45 m
PRE6300S09	9' / 2,75 m
PRE6300S10	10' / 3,05 m
PRE6300S11	11' / 3,35 m
PRE6300S12	12' / 3,65 m
PRE6300S13	13' / 3,95 m
PRE6300S14	14' / 4,25 m
PRE6300S15	15' / 4,60 m
PRE6300S16	16' / 4,90 m
PRE6300S17	17' / 5,20 m
PRE6300S18	18' / 5,50 m
PRE6300S19	19' / 5,80 m
PRE6300S20	20' / 6,10 m
PRE6300S21	21' / 6,40 m
PRE6300S22	22' / 6,70 m
PRE6300S23	23' / 7,00 m

10-32" 3" 76 mm

REF	TRAVEL
PRE6300S24	24' / 7,30 m
PRE6300S25	25' / 7,60 m
PRE6300S26	26' / 7,90 m
PRE6300S27	27' / 8,25 m
PRE6300S28	28' / 8,55 m
PRE6300S29	29' / 8,85 m
PRE6300S30	30' / 9,15 m
PRE6300S31	31' / 9,50 m
PRE6300S32	32' / 9,75 m
PRE6300S33	33' / 10,00 m
PRE6300S34	34' / 10,35 m
PRE6300S35	35' / 10,65 m
PRE6300S36	36' / 11,00 m
PRE6300S38	38' / 11,50 m
PRE6300S40	40' / 12,10 m
PRE6300S42	42' / 12,70 m
PRE6300S44	44' / 13,30 m
PRE6300S46	46' / 14,00 m

10-32" 3" 76 mm

REF	TRAVEL
PRE6300S48	48' / 14,50 m
PRE6300S50	50' / 15,00 m
PRE6300S52	52' / 15,80 m
PRE6300S54	54' / 16,40 m
PRE6300S56	56' / 17,00 m
PRE6300S58	58' / 17,60 m
PRE6300S60	60' / 18,20 m
PRE6300S62	62' / 18,80 m
PRE6300S64	64' / 19,40 m
PRE6300S66	66' / 20,00 m
PRE6300S68	68' / 20,60 m
PRE6300S70	70' / 21,20 m
PRE6300S72	72' / 21,80 m
PRE6300S74	74' / 22,50 m
PRE6300S76	76' / 23,00 m
PRE6300S78	78' / 23,70 m
PRE6300S80	80' / 24,30 m
PRE6300S82	82' / 24,90 m

10-32" 3" 76 mm

**ACCESSORIES FOR CONTROL CABLES**

**ACCESORIOS PARA CABLES DE MANDO**

**ACCESSORI CAVI COMANDI**

**ACCESSOIRES POUR CÂBLES DE COMMANDE**

REF	DESCRIPTION	DESCRIPTION	DESCRIPTION	DESCRIPTION
PRE336174	Stop collar 1	Fijador 1 cable	Fissatore 1 cavo	Fixateur 1 câble
PRE215154	Stop collar 2	Fijador 2 cable	Fissatore 2 cavi	Fixateur 2 câbles
PRE331125	Fork	Horquilla	Forcella	Chappe
PRE31799	Ball joint	Rótula	Snodo	Rotule
PRE308650	Pivot	Pivote	Perno	Pivot
GS332010	Clamp	Abrazadera	Ferma cavo	Collier
PRE331538	Shim	Platina	Piastrina	Platine
GS331980	Terminale eye	Terminal ojo	Terminale cavo	Terminal
PRE31916	SD control. Handle for throttle, choke, stop, etc	Tirador SD para cable de paro y otros usos	Tirante SD Tirante per cavi e altri usi	Poignée SD pour câble d'arrêt et autres utilisations
PRE31917	Mounting bracket for SD control	Soporte angular para tirador SD	Supporto per tirante SD	Support angulaire pour SD shooter



**UTILITY CABLE**

**CABLES DE STOP**

**CAVO DI STOP**

**TIRETTES D'ARRÊT**

REF	TRAVEL
PRE31507	7' / 2,10 m
PRE31508	8' / 2,45 m
PRE31509	9' / 2,75 m
PRE31510	10' / 3,05 m
PRE31511	11' / 3,35 m

REF	TRAVEL
PRE31512	12' / 3,65 m
PRE31513	13' / 3,95 m
PRE31514	14' / 4,25 m
PRE31515	15' / 4,60 m
PRE31516	16' / 4,90 m



pretech  
maxflex

UNIVERSAL CONTROLS AND ACCESSORIES	MANDOS UNIVERSALES Y ACCESORIOS	CONTROLLI UNIVERSALI E ACCESSORI	COMMANDES UNIVERSELLES ET ACCESSOIRES
------------------------------------	---------------------------------	----------------------------------	---------------------------------------

GLENINNING CONTROL SYSTEM	SISTEMA DE CONTROL GLENINNING	SISTEMA DI CONTROLLO GLENINNING	SYSTÈME DE COMMANDE GLENINNING
---------------------------	-------------------------------	---------------------------------	--------------------------------

**1 CHOOSE YOUR KIT**  
**ELIJA SU KIT**  
**SCEGLI LE TUE KIT**  
**CHOISISSEZ VOTRE KIT**  
 (ACTUATOR + ACCES.)

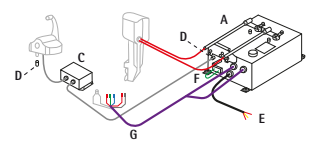

OUTBOARD/STERNDRIVE Single (1) With Trim KIT		ACTUATOR (A)	CONTENT ACCESSORIES
GLESA2A-1E-OSBD-TR12	12V DC	GLE11314-12S	C x1 CP module throt/mech gear trim D x2 Terminating resistors E x1 Harness - DC power input (9,1m) F x1 Jumper - SACT II ignition enable SGL G x1 Harness - Trim/IGN/S.I. universal (port/sgl) 6m
GLESA2A-1E-OSBD-TR24	24V DC	GLE11314-24S	C x1 CP module throt/mech gear trim D x2 Terminating resistors E x1 Harness - DC power input (9,1m) F x1 Jumper - SACT II ignition enable SGL G x1 Harness - Trim/IGN/S.I. universal (port/sgl) 6m

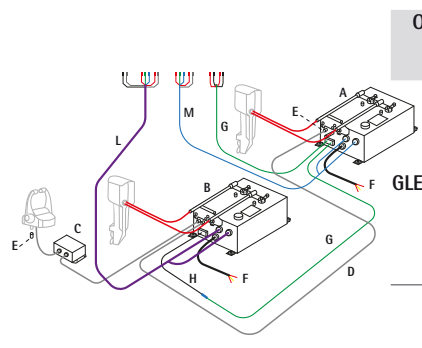

OUTBOARD/STERNDRIVE Twin (2) With Trim KIT		ACTUATOR	CONTENT ACCESSORIES
GLESA2A-2E-OSBD-TR12	12V DC	GLE11314-12S (A) STB GLE11314-12P (B) PORT	C x1 CP module throt/mech gear trim D x1 Station cable (6m) E x2 Terminating resistors F x2 Harness - DC power input (9,1m) G x1 Harness - SACT II enable/tach STBD H x1 Harness - SACT II IGN enable PORT L x1 Harness - Trim/IGN/S.I. universal (port/sgl) 6m M x1 Harness - Trim/Start int. universal (STBD/CTR) 6m G x1 Harness - Trim/IGN/S.I. universal (port/sgl) 6m
GLESA2A-2E-OSBD-TR24	24V DC	GLE11314-24S (A) STB GLE11314-24P (B) PORT	C x1 CP module throt/mech gear trim D x1 Station cable (6m) E x2 Terminating resistors F x2 Harness - DC power input (9,1m) G x1 Harness - SACT II enable/tach STBD H x1 Harness - SACT II IGN enable PORT L x1 Harness - Trim/IGN/S.I. universal (port/sgl) 6m M x1 Harness - Trim/Start int. universal (STBD/CTR) 6m G x1 Harness - Trim/IGN/S.I. universal (port/sgl) 6m

**2 CHOOSE 1 CONTROL**  
**ELIJA 1 CONTROL**  
**SCEGLI L1 COMANDO**  
**CHOISISSEZ 1 COMMANDE**

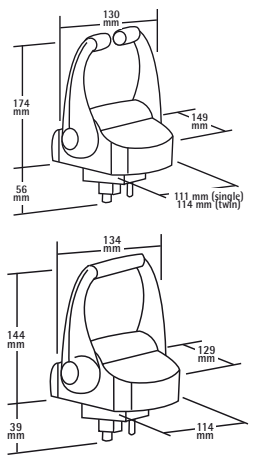

PROGRADE CHROME	
GLE11419-SGTR-P2B	SINGLE
GLE11419-TWTR-6B	TWIN

GENESYS	
GLE11420-SGTR-UC	SINGLE
GLE11420-TWTR-C	TWIN



**3 CHOOSE 1 CANbus**  
**ELIJA 1 CANbus**  
**SCEGLI L1 CANbus**  
**CHOISISSEZ 1 CANbus**

GLE11600-0210	3m	GLE11600-0260	18,3m
GLE11600-0220	6m	GLE11600-0280	24,4m
GLE11600-0230	9,1m	GLE11600-02100	30,5m
GLE11600-0240	12,2m	GLE11600-02-120	36,6m

**MECHANICAL CONTROL**

- Minimal changes to mounting scheme or cable nesting from Osprey or SL-3.
- Dual function lever controls both throttle and shift of one engine.
- Neutral interlock and start-in-gear protection (standard) for side mount controls.
- Optional TRIM / TILT in the handle.
- Neutral engine warm-up feature (standard).
- Standard lanyard-style cut-off switch for emergency engine shut down for side mount controls.
- Accepts every type of OEM and 3300/33C type cable.
- Meets/exceeds all applicable standards.

**MANDO MECÁNICO**

- Cambios mínimos en el esquema de montaje o anidamiento de cables desde Osprey o SL-3.
- Impulsiones de popa e interiores. La palanca de doble función controla el acelerador y el cambio de un motor.
- Enclavamiento neutro y protección de arranque en marcha (estándar) para controles de montaje lateral.
- TRIM/TILT opcional en el mango.
- Función de calentamiento del motor neutro (estándar).
- Interruptor de apagado de emergencia del motor para controles de montaje lateral.
- Acepta todos los tipos de cable OEM y 3300 / 33C.
- Cumple / excede todos los estándares aplicables.

**SCATOLA MECCANICHE**

- Modifiche minime dello schema di assemblaggio o di nidificazione dei cavi da Osprey o SL-3.
- Azionamenti di popa e interni. La leva a doppia funzione controlla l'acceleratore e il cambio di un motore.
- Interblocco neutro e protezione marcia in marcia (standard) per comandi di montaggio laterali.
- TRIM / TILT opzionale sul manico.
- Funzione di riscaldamento del motore neutro (standard).
- Interruttore di arresto di emergenza del motore per comandi di montaggio laterali.
- Accetta tutti i tipi di cavi OEM e 3300 / 33C.
- Soddisfa / supera tutti gli standard applicabili.

**CONTRÔLE MÉCANIQUE**

- Modifications minimes dans le schéma d'assemblage des câbles d'Osprey ou SL-3.
- Commandes latérales ou sur console. Le levier à double fonction contrôle l'accélérateur et l'inversion de marche.
- Verrouillage neutre et protection de démarrage (standard) pour les commandes à montage latéral.
- TRIM / TILT en option sur la poignée.
- Fonction de chauffage neutre du moteur (standard).
- Interrupteur d'arrêt d'urgence du moteur pour commandes à montage latéral.
- Accepte tous les types de câbles OEM et 3300 / 33C.
- Répond / dépasse toutes les normes applicables.

REF	SIDE CENTER BLACK	LATERAL CENTRAL NEGRO	LATERALE CENTRALE NERO	LATERAL CENTRAL NOIR
TXCHX8850P	Interlock Stoper, hang rope assy Interlock	Interlock Hombre al agua Interlock	Interlock Stacco aut. d'emergencia Interlock	Verrouillage Coupe circuit Verrouillage
TXCHX8852P	Stoper, hang rope assy Trim/Tilt switch	Hombre al agua Trim/Tilt	Stacco aut. d'emergencia Trim/Tilt switch	Coupe circuit Trim / Tilt

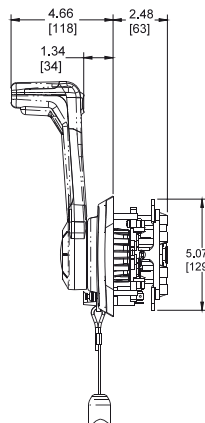

REF	SIDE BLACK	LATERAL NEGRO	LATERALE NERO	LATERAL NOIR
TXCHX8550P	Interlock Stoper, hang rope assy Interlock	Interlock Hombre al agua Interlock	Interlock Stacco aut. d'emergencia Interlock	Verrouillage Coupe circuit Verrouillage
REC22928971	Trim/Tilt switch Stoper, hang rope assy	Hombre al agua Trim/Tilt	Trim/Tilt switch Stacco aut. d'emergencia	Coupe circuit Trim/Tilt
TXCHX8553P	Interlock	Interlock	Interlock	Verrouillage
TXCHX8555P	Interlock Trim/Tilt switch	Interlock Trim/Tilt	Interlock Trim/Tilt switch	Verrouillage Trim/Tilt



**RECMAR**

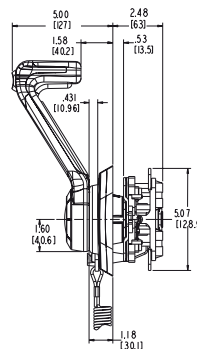
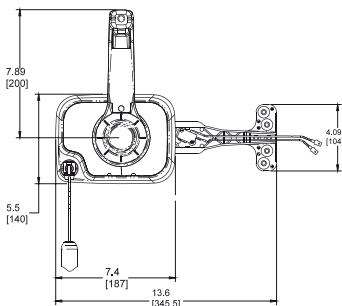

REF	CONSOLE BLACK	CONSOLA NEGRO	CONSOLLE NERO	CONSOLE NOIR
TXCHX8640P	Standard	Estándar	Standard	Standard
REC22928974	Trim/Tilt switch	Trim/Tilt	Trim/Tilt switch	Trim/Tilt
TXCHX8650P	Interlock	Interlock	Interlock	Verrouillage
TXCHX8652P	Interlock Trim/Tilt	Interlock Trim/Tilt	Interlock Trim/Tilt	Verrouillage Trim/Tilt



RECMAR®

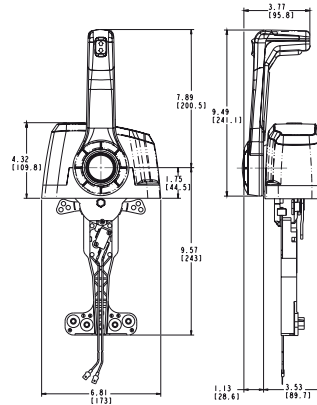

REF	CONSOLE CHROME	CONSOLA CROMADO	CONSOLLE CROMATO	CONSOLE CHROME
TXCHX8150P	Interlock	Interlock	Interlock	Verrouillage
REC22928974CR	Interlock Trim/Tilt	Interlock Trim/Tilt	Interlock Trim/Tilt	Verrouillage Trim/Tilt



RECMAR®



REF	CONSOLE BLACK	CONSOLA NEGRO	CONSOLLE NERO	CONSOLE NOIR
TXCHX8740P	Standard	Estándar	Standard	Standard
REC22928976	Trim/Tilt	Trim/Tilt	Trim/Tilt	Trim/Tilt



RECMAR®

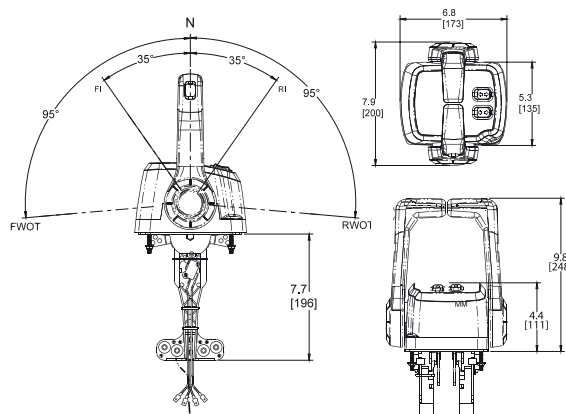

REF	CONSOLE CHROME	CONSOLA CROMADO	CONSOLLE CROMATO	CONSOLE CHROME
TXCHX8240P	Standard	Estándar	Standard	Standard
REC22928976CR	Trim/Tilt	Trim/Tilt	Trim/Tilt	Trim/Tilt



RECMAR®



**MECHANICAL CONSOLE CONTROL**

- Chrome plated control for dual function by lever (clutch and throttle).
- Handle pulls out to operate neutral throttle
- Neutral safety switch to ensure engine only starts when in neutral.

**MANDO MECÁNICO CONSOLA**

- Palanca con doble función (acelerador y cambio).
- Carcasa cromada de fundición.
- Interruptor de protección de arranque en punto muerto.
- Aceleración en punto muerto por desplazamiento exterior de la palanca.

**SCATOLA MECCANICHE CONSOLLE**

- Leve con doppia funzione (acceleratore e cambio).
- Struttura cromata.
- Interruttore di protezione di accensione nel Folle.
- Acceleratore nel Folle per il distanziamento esterno dalla leva.

**CONTRÔLE MÉCANIQUE CONSOLE**

- Levier à double fonction (accélérateur et inverseur).
- Boîtier en fonte chromée.
- Interrupteur de démarrage au point mort.
- Accélération au point mort entrant le levier vers l'extérieur.

REF	33-C 3300C	1 2
1 REC308601		1
2 REC308602		2

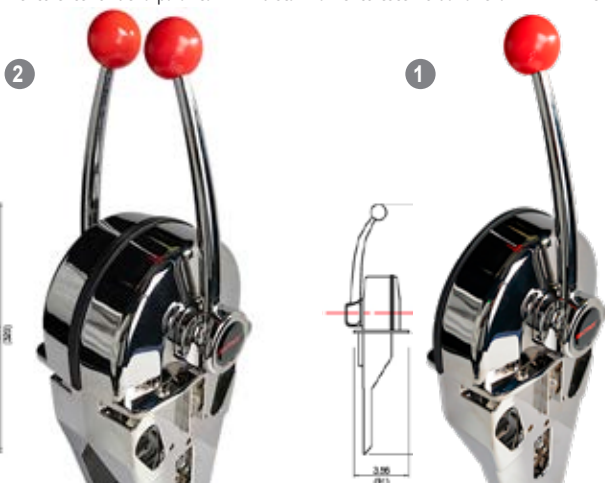
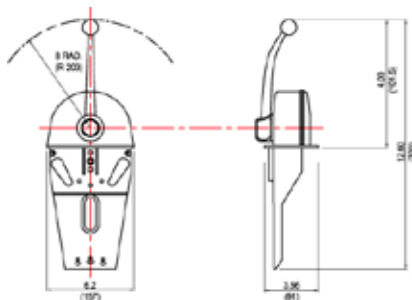

**RECMAR**

- This control is made of all stainless steel inside and outside.
- One handle is for clutch (black) and other one is for throttle (red handle).

- Completamente de acero inoxidable por dentro y por fuera.
- Una manija es para embrague (negra) y otra es para acelerador (manija roja).

- Questo controllo è realizzato interamente in acciaio inossidabile all'interno e all'esterno.
- Una maniglia è per la frizione (nera) e l'altra è per l'acceleratore (manopola rossa).

- Cette commande est réalisée entièrement en acier inoxydable à l'intérieur et à l'extérieur.
- Une poignée est pour l'embrayage (noir) et l'autre pour l'accélérateur (poignée rouge).

REF	1
PRE30050	1



**pretech**

- Chrome plated heavy duty single function control for clutch and throttle.
- With twisting brake on throttle handle.

- Palanca de función única. (1 acelerador + 1 inversor).
- Para trabajos pesados.
- Con freno en la palanca de acelerador.
- Con interruptor de protección de arranque en punto muerto.

- Leva con unica funzione (1 acceleratore + 1 invertitore).
- Corpo e leve in acciaio cromato.
- Con interruttore di protezione di partenza nel folle.

- Levier à fonction unique. (1 accélérateur + 1 inverseur).
- Pour les travaux lourds.
- Avec frein sur le levier d'accélérateur.
- Interrupteur de démarrage au point mort.

REF	33-C 3300C
PRE36468	

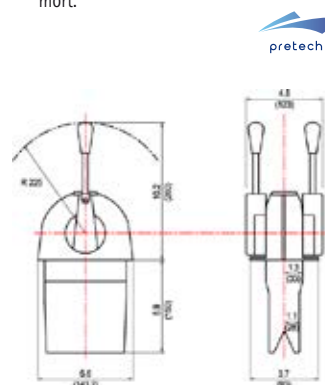

**pretech**

**DUAL STATION TO 1 ENGINE TRANSFER UNIT**

**DIFERENCIAL DOBLE PUENTE A 1 MOTOR**

**DIFFERENZIALE DOPPIA STAZIONE A 1 MOTORE**

**DIFFÉRENTIEL DOUBLE POUR 1 MOTEUR**

REF	33-C 3300S
GS40010	

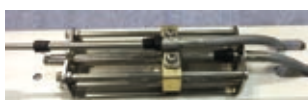

**GOLDENSHIP**

STEERING WHEELS

VOLANTES

VOLANTI

VOLANTS

STEERING WHEELS	VOLANTES		VOLANTI	VOLANTS
-----------------	----------	--	---------	---------

REF					Ø
PREMF33521	Black	Negro	Nero	Noir	350 mm
PREMF33581	Chromed	Cromado	Cromato	Chromé	
PREMF34521	Overmolded	Sobremoldeado	Sovrastampato	Surmoulé	

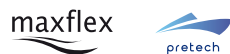

PREMF33521



PREMF33581



PREMF34521

REF					Ø		
GS41280	GS41283	GS41282	GS41285	GS41286	GS41287	■	AL
GS41281	GS41284					□	



GS41280

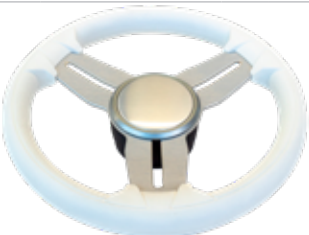

GS41281



GS41283



GS41284



GS41282



GS41285



GS41286



GS41287

REF	Ø		A	
GS41122	■ 350 mm	5/8-3/4"	115mm	PLASTIC
GS41123	■ 320 mm	16 - 19 mm	110 mm	NYLON



GS41122



GS41123

REF			Ø		A		
GS41119	- stainless steel wheel in mahogany wood	- Acero inox - aro de madera de caoba barnizada	- In acciaio inox - impugnatura in TEAK	- Fabriqué en inox - roue en acajou	350 mm	5/8-3/4" 16 - 19 mm	105 mm

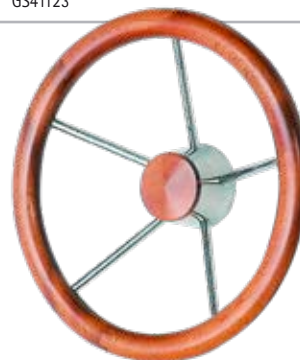

BEACH	MARPAC	VORTICE	OCEANO	MARINA	COMBI	ATLANTIC	ALBATROS	Ø			GOLDENSHIP
GS41135		GS41140	GS41143	GS41145	GS41147	GS41137	■	350 mm	5/8-3/4" 16 - 19 mm	AL (anodiz.) Polyurethane	GOLDENSHIP
GS41134					GS41141	□					
		GS41144			GS41136	■					
						GS41133	■	330 mm		AL (anodiz.) SKAY Polyurethane	
		GS41127					■				



GS41135



GS41134



GS41127



GS41140



GS41144



GS41143



GS41145



GS41147



GS41137



GS41141



GS41136



GS41133

REF	SERIE
GS41129	VORTICE OCEANO MARINA COMBI ATLANTIC ALBATROS



REF		Ø	
GS41110	- stainless steel - hub with plastic cap	400 mm	5/8-3/4" 16 - 19 mm
GS41115	- stainless steel - hub with plastic cap - wheel covered with foam cover		
	- Acero inox - embellecedor de baquelita.		
	- Acero inox - embellecedor de baquelita.		
	- In acciaio inox - coprimozzo in bachelite		
	- In acciaio inox - coprimozzo in bachelite		
	- Anello esterno rivestito in neoprene		
	- Fabriqué en inox - capuchon en plastique		
	- Fabriqué en inox - capuchon en plastique		
	- recouvert en néoprene		



GS41110



GS41115

### INSTALLATION ACCESSORIES

#### PROTECTIVE CABLE SYSTEM

- This system gives a good protection to the service cables of outboard engines against dirt and corrosion.
- Available in two diameters, complete with fittings in black colour.
- Hose in grey colour.

### ACCESORIOS DE INSTALACION

#### MANGUERA DE PROTECCIÓN

- Manguera de protección para los cables de dirección, mando, etc. desde la salida del casco hasta el motor, presentando un sólo núcleo limpio y ordenado.
- Color gris.

REF					Ø INT (mm)
1 GS41164 GS41165	Kit	Kit	Kit	Kit	80 cm
2 GS41160	Hull end fitting	Terminal casco	Terminale scafo	Terminal coque	50
3 GS41166					32
4 GS41161 GS41167	Hose	Manguera	Tubo	Gaine	15 m
5 GS41162 GS41168	Engine end fitting	Terminal motor	Terminale motore	Terminal moteur	50 32

### ACCESSORI DIREZIONE

#### TUBO DI PROTEZIONE

- Tubo di protezione per cavi di timoneria, comando etc. dall'uscita dello scafo fino al motore, per tenere i cavi ordinati.
- Colore grigio.

### ACCESSOIRES D'INSTALLATION

#### GAINE DE PROTECTION

- Gaine de protection pour les câbles de direction, de commande, etc. de la sortie de coque au moteur, présentant un seul fourreau propre et bien rangé.
- Gris.



#### CABLE BOOTS

- Finishes and protects pass thru hole for wires and cables.
- Rugged marine vinyl.
- Resists UV, gasoline and oil.
- Cable tie snugs around wires and cables.

#### ARO PROTECTOR

- Protección de los cables de control y dirección.
- Vinilo marino resistente a los rayos U.V., gasolina y aceites.
- Se ajusta alrededor de los cables.

#### CUFFIA PASSACAVO

- Protezione di cavi di controllo e di comando.
- Vinile marino resistente a raggi UV, benzina e oli.
- Si adatta attorno ai cavi.

#### ANNEAU DE PROTECTION

- Protection des câbles de commande et de direction.
- Vinyle marin résistant aux rayons UV, à l'essence et aux huiles.
- Il s'adapte autour des fils.

REF	HOLE AGUJERO FORI TROU		
THCB-2	2"		
THCB-1	3"	1	
THCB-4	4 1/2"		



REF	HOLE AGUJERO FORI TROU		
THCB-2W	2"		
THCB-W	3"		
THCB-4W	4 1/2"		



#### STEERING GUARD

- Steering guard to be installed in all cable and side mounted hydraulic steering systems to lubricate clean and seal the systems.
- Made of stainless steel.

#### TUERCA DE ENGRASE

- Tuerca engrasadora para todos los cables de dirección.
- Sella el cable evitando el agua y la corrosión.

#### DADO LUBRIFICANTE

- Dado lubrificante per tutti i cavi di timoneria.
- Chiude il cavo evitando l'acqua e la corrosione.

#### ÉCROU DE GRAISSAGE

- Écrou de graissage pour tous les câbles de direction.
- Scellez le câble en évitant l'eau et la corrosion.

REF			
GS41170	7/8"	SS / inox	1



#### TRANSOM SUPPORT PLATE

#### CONTRAPLACA TRANSOM

#### CONTROPIASTRA

#### CONTRE-PLAQUE

REF		THICKNESS GRUESO SPESSORE EPAISSEUR	
THTSP-1	15" x 2"	13"	3/8" 10 mm
REC330TP	13" 330 mm		AL
REC250TP	10" 250 mm		



**PROTECTION PLATE**

- Aluminum transom plate complete with support and tube for steering cable.

REF	(mm)
GS73132	280 x 115

**PROTECTOR ESPEJO**

- Fabricada en aluminio.
- Con soporte para terminal del cable de dirección.

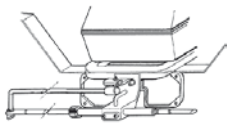

**PIASTRA SALVA POPPA**

- Fabricata in alluminio.
- Con supporto per i cavi di timoneria.

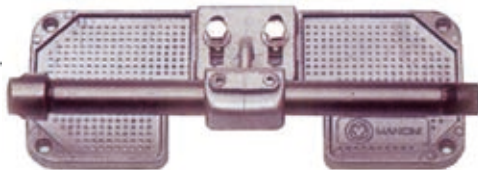

**PLAQUE DE PROTECTION**

- Fabriqué en aluminium
- Avec support pour de câble de direction.

REF	(mm)		
1 GS73133	430 x 350	□	plastic
2 GS73130	225 x 85	■	
GS73131	270 x 100	■	



- Made in solid UV resistant polypropilene.
- Colour white.

- Fabricada en polipropileno resistente a los rayos UV.
- Color blanco.

- Fabricata in polipropileno resistente ai raggi UV.
- Colore bianco

- Fabriqué en polypropylène résistant aux UV.
- Couleur blanche.

REF	A (mm)	B (mm)	C (mm)	THICKNESS GRUESO SPESSORE ÉPAISSEUR (mm)
OCE100133	390	350	330	8
OCE100134	390	350	330	15



**15**

**HYDROFOIL STABILIZER AND SECURITY**

**ESTABILIZADORES, ELEVADORES Y SEGURIDAD**

**STABILIZZATORI, ASCENSORI E SICUREZZA**

**STABILISATEURS, POWER TRIM-LIFT ET SECURITE**

**HYDROFOIL STABILIZER**

**ALETAS ESTABILIZADORAS**

**ALETTE**

**HYDROFOIL**

MOD.	REF				
XR4	SRXR4	40-300 HP	18.5 cm	2	
STARFIRE	SRSF	40-300 HP	18.5 cm		✓
Classic PRO	SRPRO1	40-300 HP	18.5 cm		✓
CLASSIC 2	SRSR2-1	40-300 HP	18.5 cm	4	
CLASSIC 2 JUNIOR	SRJR2-1	9.9-40 HP	18.5 cm	4	



SRPRO1



SRSR2-1



SRXR4



SRSF



SRJR2-1

REF		
SEA94000	35-300 HP	4
SEA94010	<50 HP	4

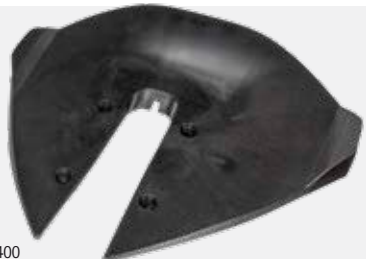

SEA9400



SEA9401

**NEW**



**POWER TRIM-LIFT**

- Made with extruded aluminum and stainless steel fasteners.

**POWER TRIM-LIFT**



- Fabricado en extrusión de aluminio con tornillos de acero inox.

**POWER TRIM-LIFT**

- Fabbricato in alluminio con viti in acciaio inox.

**POWER TRIM-LIFT**

- Fabriqué en aluminium extrudé avec des vis en acier inoxydable.

REF		TRIM	TILT		MOTOR	Set-Back from transom Separación del espejo Specchio di poppa Recul de traverse
1 CMC13002Q CMC13001Q	-130 HP	20°	90°		12 V 3500 kg 7800 lbs	152 mm 6"
2 CMC52100D	-35 HP	84°			12 V	140 mm 5 1/2"







**POWER LIFT**

**POWER LIFT**

**POWER LIFT**

**POWER LIFT**

REF						Set-Back from transom Separación del espejo Specchio di poppa Recul de traverse
THAHJM-4DP	75 HP	125 mm 5"	3/4" SS / inox	✓	12 V	37 x 30 cm 14 5/8" x 11 1/2"









- Made of 1/2" 6061 T6 alloy aluminum extrusions and stainless steel fasteners.  
- Totally waterproof electro-hydraulic power lift transom jack with a rated thrust of 7800 lbs.

- Fabricado en extrusión de aluminio con tornillos de acero inox.  
- Tornillos de de acero inoxidable, con tuercas de aleación de aluminio y bronce resistentes a los choques y corrosión.

- Fabbricato in alluminio con viti in acciaio inox.  
- Viti da 3/4" in acciaio inox, con dadi in alluminio e bronzo resistenti alla corrosione.

- Support avec kit de levage vertical.  
- Fabriqué en aluminium extrudé avec des vis en acier inoxydable.  
- Vis 3/4" en acier inoxydable, avec écrous en alliage d'aluminium et de bronze résistant aux chocs et à la corrosion.

REF							MOTOR	Set-Back from transom Separación del espejo Specchio di poppa Recul de traverse
1 CMC65001Q	V6	125 mm 5"	460 x 420 mm 18 1/8" x 16 1/2"	3/4" SS / inox	✓	12 V	3500 kg 7800 lbs	140 mm 5 1/2"
2 CMC65501	V8 300HP							
3 CMC61001Q								254 mm / 10"







- The product adjusts the height of the propeller from the water to increase the ship's shoal passing capacity.
- Can adjust the wading depth of the outboard motor to reduce resistance, achieve a semi-paddle state of the propeller, and increase the speed of the boat.
- It adjusts the height stably and will not reduce the height of the jackplate while driving or stopping.
- The material is processed and formed from 7009 aviation aluminum. The material has high resilience and greatly improves its service life.
- The product surface treatment adopts hard anodizing, which has high corrosion resistance.

- Ajusta la altura de la hélice respecto al agua para aumentar la capacidad de navegar por aguas poco profundas.
- Permite ajustar la profundidad de inmersión del motor fueraborda para reducir la resistencia, lograr un estado de semipropulsión de la hélice y aumentar la velocidad de la embarcación.
- Ajusta la altura de forma estable y no reducirá la altura de la placa elevadora (jackplate) mientras se navega o se está parado.
- El material está procesado y conformado con aluminio aeronáutico 7009, tiene una alta resiliencia y mejora en gran medida su vida útil.
- El tratamiento de la superficie adopta un anodizado duro, que tiene una alta resistencia a la corrosión.

- Il prodotto regola l'altezza dell'elica dall'acqua per aumentare la capacità di passaggio della nave in acque poco profonde.
- Si può regolare la profondità di guado del motore fuoribordo per ridurre la resistenza, ottenere uno stato semi-pagaia dell'elica e aumentare la velocità dell'imbarcazione.
- Regola l'altezza in modo stabile e non riduce l'altezza del jackplate durante la guida o l'arresto.
- Il materiale è lavorato e formato da alluminio aeronautico 7009. Ha un'elevata resilienza e migliora notevolmente la sua durata.
- Il trattamento superficiale adotta l'anodizzazione dura, che ha un'elevata resistenza alla corrosione.

- Le produit ajuste la hauteur de l'hélice par rapport à l'eau afin d'augmenter la capacité du bateau à franchir les hauts-fonds.
- Permet d'ajuster la profondeur de passage du moteur hors-bord afin de réduire la résistance, d'obtenir un état semi-pagaie de l'hélice et d'augmenter la vitesse du bateau.
- Il ajuste la hauteur de manière stable et ne réduit pas la hauteur de la plaque de levage pendant la conduite ou l'arrêt.
- Le matériau est traité et formé à partir d'aluminium aéronautique 7009. Ce matériau présente une grande résilience et améliore considérablement sa durée de vie.
- Le traitement de surface adopte une anodisation dure, qui offre une grande résistance à la corrosion.

REF    

**RECJP5060R**    115-500 HP    152 mm / 6"    4000 KG    12 V

**RECMAR®**

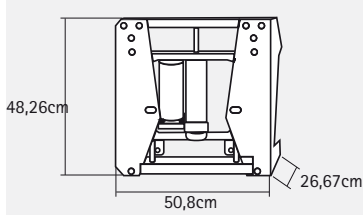

**NEW**

**POWER TRIM ASSY (-90HP)**    **POWER TRIM COMPLETO (-90HP)**    **POWER TRIM COMPLETO (-90HP)**    **POWER TRIM COMPLET (-90HP)**

REF				
<b>RECPT3090R</b>	Jacking Force	Fuerza de elevación	Forza di sollevamento	Force de levage
	Max Load Horsepower	Potencia máxima	Potenza massima	Puissance maximale
	Max Load Weight	Peso de carga máx.	Peso massimo di carico	Poids maximal de la charge
	Wide of Motor Side	Ancho bracket de motor	Larghezza bracket motore	Largeur du bracket moteur
	Tall of Motor Side	Altura bracket de motor	Altezza bracket motore	Hauteur du bracket moteur
	Wide of Transom Side	Ancho espejo de popa	Larghezza specchio di poppa	Largeur du traverse
	Tall of Transom Side	Altura espejo de popa	Altezza specchio di poppa	Hauteur du traverse
	Height	Altura	Altezza	Hauteur
	Length of Travel	Longitud de recorrido	Lunghezza corsa	Longueur de course
	Net Weight	Peso neto	Peso netto	Poids net
	Gross Weight	Peso bruto	Peso lordo	Poids brut
	Motor Power	Potencia del motor	Potenza motore	Puissance moteur
	Min Angle of Tilt	Ángulo mínimo de inclinación	Angolo minimo di inclinazione	Angle d'inclinaison minimal
	Max Angle of Tilt	Ángulo máximo de inclinación	Angolo massimo di inclinazione	Angle d'inclinaison maximal
	Size	Dimensiones	Dimensioni	Dimensions
	Packing Size	Tamaño del empaque	Dimensioni dell'imballaggio	Dimensions de l'emballage
	Includes	Incluye	Include	Comprend
				15.7kn (1.6tf)
				90hp
				238 lb (108 kg)
				360mm
				256mm
				388mm
				280mm
				182mm (7.2")
				92mm (3.6")
				13.7 kg
				15.1 kg
				12v
				-6°
				53°
				367 x 396 x 182 mm
				40.5 x 38 x 21.5 cm
				Harness, relay and switch



**NEW**

**RECMAR®**

SPARE PARTS		RECAMBIOS	RICAMBI	PIECES DETACHÉES	
REF					
1	CMC12525	Bearing strip plate	Placas laterales	Piastra laterale	Plaque laterale
2	CMC51290	Top clevis bracket	Soporte superior	Supporto superiore	Support superieur
3	CMC51300	Bottom clevis bracket	Soporte motor inferior	Supporto motore parte inferiore	Support inferieur
4	CMC51127	Position indicator tilt gauge	Reloj indicador tilt	Orologio indicatore tilt	Jauge indicateur tilt
	CMC6045	Gauge CMC65501	Reloj CMC65501	Reloj CMC65501	Jauge CMC65501
5	CMC51207	Position indicator gauge kit	Reloj indicador de posicion	Reloj indicador de posicion	Kit jauge indicateur de position
6	CMC6077	Position indicator gauge kit	Reloj indicador posicion	Kit indicatore posizione	Kit indicateur de position
7	CMC6044	Position indicator gauge sending unit	Sensor trim/tilt	Trim/tilt sensore	Trim/tilt senseur
8	CMC7050D	Hydraulic motor actuator assembly	Motor de trim	Motore trim	Moteur de trim
	CMC7342	Hydraulic motor actuator assembly	Motor de trim para #52100	Motore trim	Moteur de trim
9	CMC7186	Circuit breaker	Fusible	Circuit breaker	Fusible
10	CMC7493	Relay CMC 12V 80A.	Rele CMC 12V 80A.	Rele CMC 12V 80A	Relai CMC 12V 80A



BACK SPACERS. POWER TRIM-LIFT	ADAPTADORES. POWER TRIM-LIFT	ADATTATORI. POWER TRIM-LIFT	ADAPTEURS POWER TRIM-LIFT
-------------------------------	------------------------------	-----------------------------	---------------------------

REF		
CMC20122Q	2°	2



- Adaptors kit for motors mounted with transom clamps. - Kit de adaptadores para la instalación de motores con palomillas. - Kit per l'installazione di motori con chiusura con galletti. - Kit d'adaptateur pour l'installation du moteur.

REF	
CMC13022Q	

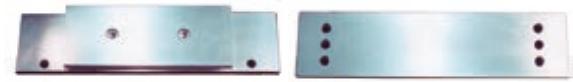

REF	
THAHJM-CMADP	75 HP



HOISTING HARNESS	ARNÉS FUERABORDA	IMBRAGATURA FUORIBORDO	HARNAIS HORS-BORD
------------------	------------------	------------------------	-------------------

REF	
GS73069	2 --> 15 hp



EXTENSION HANDLE OUTBOARD	ALARGO BARRA FUERABORDA	PROLUNGA PER FUORIBORDO	RALLONGE DE BARRE FRANCHE
---------------------------	-------------------------	-------------------------	---------------------------

- With push-button to switch-off the engine.  
- Made of anodized aluminum and plastic handle.

- Prolongador de caña con pulsador de paro, para motores fueraborda.  
- Fabricado en aluminio anodizado y maneta de plástico.

- Prolunga per fuoribordo, fabbricato in alluminio anodizzato e impugnatura in plastica.





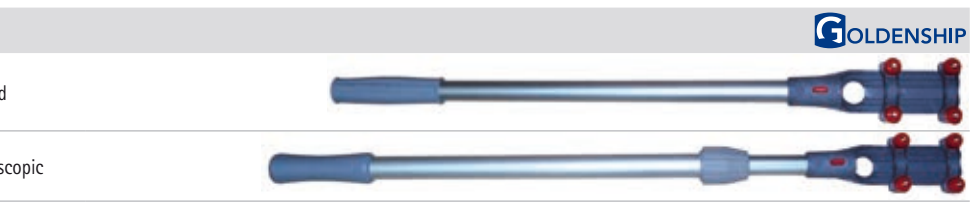

- Rallonge de barre franche avec bouton d'arrêt, pour moteurs hors-bord.  
- Fabriqué en aluminium anodisé et poignée en plastique.

REF	(cm)	
GS73135	70	Fixed
GS73136	60 - 100	Telescopic



**PROPELLER PROTECTOR**

- Manufactured in high impact polypropylene.
- Better control in directional force.
- Increase the propeller efficiency.
- NOTE: All hp's with «Big Foot» and High Thrust applications require next size up.

REF			Ø INT	max.
REC5-9.8		5 - 9 HP	9"	30 kn
REC9.9-20		9.9 - 20 HP	9"	
REC25-35		25 - 35 HP	11"	
REC40-65		40 - 65 HP	13"	
REC70-100		70 - 100 HP	14"	
REC110-230		110 - 230 HP	16"	

**RECMAR®**



**PROTECTOR DE HÉLICES**

- Mejora el control direccional y aumentando la eficiencia de la hélice.
- Fabricado en polipropileno de alto impacto.
- NOTA: Todos los motores «Big Foot» y de arrastre requieren la medida superior.

**PROTETTORI ELICHE**

- Migliora il controllo direzionale e aumentando l'efficienza delle eliche.
- Prodotto in polipropilene di alta qualità.
- NOTA: Tutti i motori «Big Foot» a alta spinta richiedono la referenza superiore.



**PROTECTION D'HÉLICE**

- Améliore le contrôle directionnel et augmente l'efficacité de l'hélice.
- Fabriqué en polypropylène résistant aux chocs.
- REMARQUE: Tous les moteurs "Big Foot" et à forte poussée nécessitent la taille supérieure.



**ANTI THEFT**

- Manufactured in 3 mm stainless steel pipe.
- Provided with a padlock in brass with 2 keys

REF	
GS73138	240 mm
GS73139	320 mm

**GOLDENSHIP**

**ANTI-ROBO**

- Fabricado en acero inox. de 3 mm con candado de latón con 2 llaves.



**ANTI-FURTO**

- Prodotto in acciaio inox da 3 mm con lucchetto in ottone con 2 chiavi.

**ANTIVOL**

- Fabriqué en acier inoxydable. 3 mm avec serrure en laiton livré avec 2 clés.

**OUTBOARD COVERS**

- Manufactured in 320 gsm polyester canvas.
- Weather proof, breathable.
- Reinforced top stitched seams.

**FUNDAS PARA FUERABORDA**

- Confeccionadas en tejido de poliéster de 320 g/m2.
- Impermeabilizado, transpirable.
- Costuras reforzadas.

**COPERTURA FUORIBORDO**

- Confezionato in tessuto di poliestere da 320 g/m2.
- Impermeabile, traspirante.
- Cuciture rinforzate.

**HOUSES POUR HORS-BORD**

- Fabriqué en tissu polyester 320g/m2.
- Imperméable, respirant.
- Coutures renforcées.

A		A	B	C
OCEMA0741	- 15 hp	32 cm	27 cm	50 cm
OCEMA0742	15-30 hp	40 cm	30 cm	56 cm
OCEMA0743	30-60 hp	49 cm	36 cm	62 cm
OCEMA0744	60-100 hp	53 cm	40 cm	68 cm
OCEMA0745	100-150 hp	58 cm	46 cm	74 cm
OCEMA0746	175-250 hp	60 cm	50 cm	82 cm
B				
OCEMA0751	- 6 hp	98 cm	126 cm	
OCEMA0752	8 - 15 hp	110 cm	140 cm	
OCEMA0753	15 - 20 hp	125 cm	150 cm	
OCEMA0754	20 - 30 hp	137 cm	165 cm	
OCEMA0755	30 - 60 hp	144 cm	180 cm	
OCEMA0756	60 - 100 hp	170 cm	200 cm	
OCEMA0757	115 - 150 hp	190 cm	226 cm	
OCEMA0758	175 - 250 hp	197 cm	248 cm	
OCEMA0759	200 - 300 hp	210 cm	254 cm	
OCEMA0759L	250 - 300 hp	30"		Offshore



**OCEANSOUTH**



**MERCURY**

	
OCEM000S OCEM000V	2018+ V8 4.6L 250HP, 300HP et 200 - 300PRO XS
OCEM000S OCEM000V	2005+ VERADO 6CYL 2.6L 200 TO 400HP
OCEM02S OCEM02V	V6 3.4L 175/200HP 225HP
OCEM10S OCEM10V	2011+ 4CYL 3.0L 135HP, 150HP
OCEM115S OCEM115V	2014+ 4CYL 2.1L 75HP, 80HP, 90HP, 100HP 115HP
OCEM20S	2008+ 4CYL 995CC 40HP, 50HP, 60HP
OCEM25S	2008+ 3CYL 747CC 40HP
OCEM30S	2007+ 3CYL 526CC 25HP, 30HP
OCEM35S	2018+ 2CYL 333CC 15HP, 20HP
OCEM40S	2006+ 2CYL 209CC 8HP, 9.9HP
OCEM45S	2012+ 1CYL 123CC 4HP, 5HP, 6HP
OCEM50S	2007+ 1CYL 85CC 2.5HP, 3.5HP



**OCEANSOUTH**



YAMAHA

			
<b>OCEY000S</b>	<b>OCEY000V</b>	2018+	XTO V8 5.6L F425A
<b>OCEY00S</b>	<b>OCEY00V</b>	2007+	V8 5.3L F350A
<b>OCEY05S</b>	<b>OCEY05V</b>	2010+	V6 4.2L F225F, F250D, F300B
<b>OCEY10S</b>	<b>OCEY10V</b>	2015+	4CYL 2.8L F150D, F175A, F200F
<b>OCEY15S</b>		2016+	4CYL 2.7L F150D
<b>OCEY20S</b>	<b>OCEY20V</b>	2015+	4CYL 1.8L F115B, F130A
<b>OCEY24S</b>	<b>OCEY24V</b>	2017+	4CYL 1.8L F75D, F90C, F100F
<b>OCEY25S</b>		2010+	CYL 996CC F50H, F60F, F70A
<b>OCEY30S</b>		2009+	3CYL 747CC F30B, F40F
<b>OCEY35AS</b>		2017+	2CYL 432CC F25G
<b>OCEY35S</b>		2010+	2CYL 498CC F25D
<b>OCEY40S</b>		2007+	2CYL 362CC F15C, F20B
<b>OCEY45S</b>		2013+	2CYL 212CC F8F, F9.9J
<b>OCEY50S</b>		2010+	1CYL 139CC F4B, F5A, F6C
<b>OCEY55S</b>		2015+	1CYL 72CC F2.5B



OCEANSOUTH



SUZUKI

			
<b>OCES000S</b>	<b>OCES000V</b>	2017+	V6 4.4L DF350A, DF325A
<b>OCES00S</b>	<b>OCES00V</b>	2012+	V6 4.0L DF250AP, DF300AP
<b>OCES05S</b>	<b>OCES05V</b>	2003+	V6 3.6L DF200, DF225, DF250
<b>OCES06S</b>	<b>OCES06V</b>	2014+	4CYL 2.8L DF150AP, DF175AP, DF200AP
<b>OCES10S</b>	<b>OCES10V</b>	2005+	4CYL 2.8L DF150, DF175
<b>OCES15S</b>	<b>OCES15V</b>	2012-	4CYL 2.0L DF100A, DF115A, DF140A
<b>OCES20S</b>		2008+	4CYL 1.5L DF70A, DF80A, DF90A
<b>OCES25S</b>		2010+	3CYL DF40A, DF50A, DF60A
<b>OCES30S</b>		2014+	3CYL DF25A, DF30A
<b>OCES35S</b>		2012+	2CYL 327CC DF15A, DF20A
<b>OCES40S</b>		2010+	1CYL 208CC DF8A, DF9.9A
<b>OCES45S</b>		2002+	1CYL 138CC DF4A, DF5A, DF6A
<b>OCES50S</b>		2006+	1CYL 68CC DF2.5



OCEANSOUTH



HONDA

			
<b>OCEH00-S</b>	<b>OCEH00V</b>	2011+	V6 3.6L BF250
<b>OCEH00A-S</b>		2019+	V6 3.6L BF200, BF225, BF250
<b>OCEH05-S</b>	<b>OCEH05V</b>	2010+	V6 3.5L BF175, BF200, BF225
<b>OCEH10-S</b>	<b>OCEH10V</b>	2010+	4CYL 2.3L BF115, BF135, BF150
<b>OCEH15-S</b>	<b>OCEH15V</b>	2014+	4CYL 1.5L BF75, BF80, BF90, BF100
<b>OCEH20-S</b>		2009+	3CYL 1L BF60 (2009) BFP60
<b>OCEH25-S</b>		2017+	3CYL 808CC BF40, BF50
<b>OCEH30-S</b>		2002+	3CYL 552CC BF25, BF30
<b>OCEH35-S</b>		2002+	2CYL 350CC BF15, BF20
<b>OCEH40-S</b>		2000+	2CYL 222CC BF8, BF9.9, BF10
<b>OCEH45-S</b>		2016+	1CYL 127CC BF4, BF5, BF6
<b>OCEH50-S</b>		2014+	1CYL 57CC BF2.3



OCEANSOUTH

PARSUN

		
<b>OCEY55S</b>	2010+	F2.5
<b>OCEY50S</b>	2010+	F4, F5
<b>OCEY40S</b>	2015+	F15A, F20A
<b>OCEY30S</b>	2015+	F30, F40, F15PRO
<b>OCEY25S</b>	2015+	F50, F60
<b>OCEY20S</b>	2015+	F90, F100, F115, F130



OCEANSOUTH

**NEW**

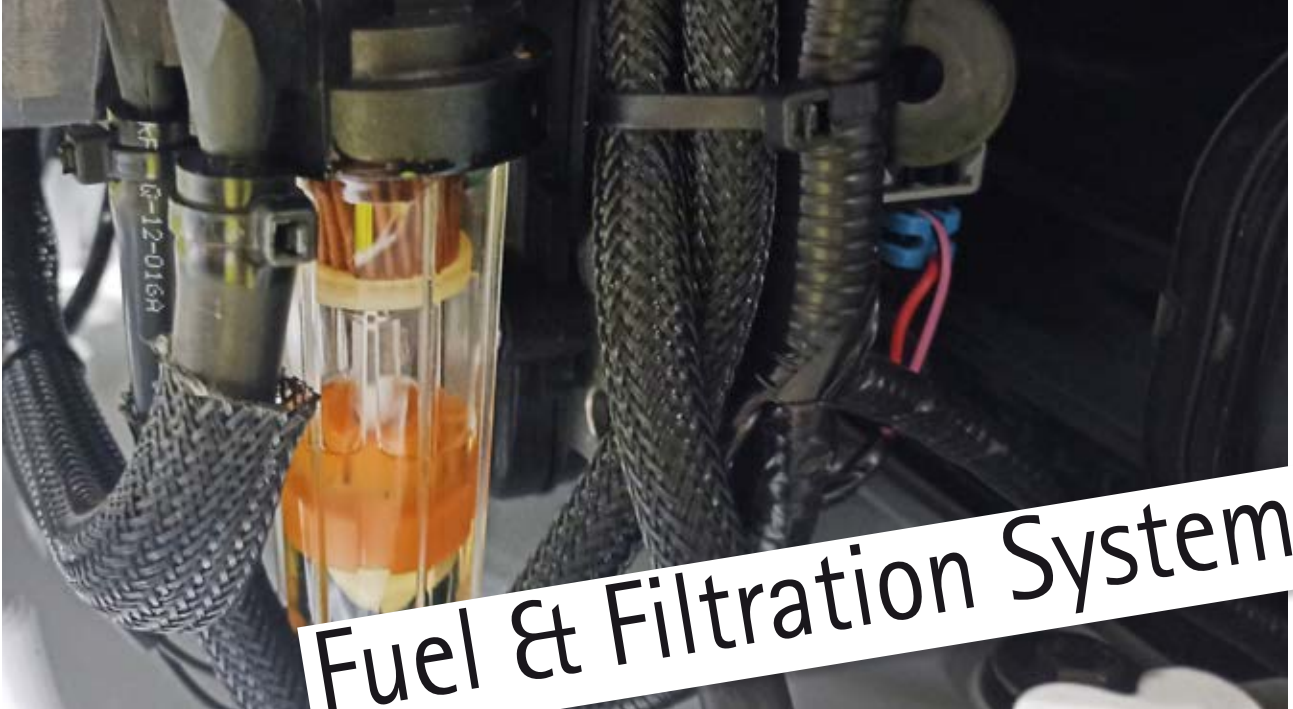

# Fuel & Filtration System

## FUEL & FILTRATION SYSTEM

## SISTEMA DE ALIMENTACIÓN Y FILTRACIÓN

## SISTEMA DI ALIMENTAZIONE E FILTRAZIONE

## SYSTÈME D'ALIMENTATION ET DE FILTRATION

1

### FUEL PUMP

#### FUEL PUMP

- Premium quality bulb
- Resistance to alcohol as well as UV.

REF	
GS31187	1/4" = 6 mm
GS31090	
SIE18-8004	5/16" = 8 mm
PAF115-10010000-A	

#### FUEL LINE ASSEMBLY

- Universal.
- Alcohol resistant hose.

REF	
1 GS31096	5/16" x 2 m
2 SIE18-8013	5/16" x 2 m
1 GS31097	3/8" x 2 m
2 SIE18-8015	3/8" x 2 m
3 GS31183	6 mm x 3 m
3 GS31099	8 mm x 2 m

#### SPRING AND CLAMP SMALL

REF		
1 PAF4-04000030		
PAF4-05000010		
2 REC650-24351-51	6 mm	
REC6E5-24351-51	8 mm	
3 REC09401-11425	6-8 mm	1
REC09401-11425BULK	6-8 mm	25

#### COUPLER

REF		Ø
REC22-8M0001721		11 --> 9 mm

### BOMBA DE COMBUSTIBLE

#### BOMBA DE COMBUSTIBLE

- Elastómeros termoplásticos inyectados
- Resistentes al alcohol y rayos UV

REF	
GS31095	3/8" = 9.5 mm
SIE18-8005	

#### BOMBA DE COMBUSTIBLE

- Universal.
- Manguera resistente al alcohol.



#### MUELLES Y ABRAZADERAS

#### ADPATADOR LÍNEA DE COMBUSTIBLE

### POMPA BENZINA

#### POMPA BENZINA

- Elastomero termoplastico
- Resistente ai solventi e raggi UV.

#### TUBO CARBURANTE

- Universale.
- Tubo resistente ai solventi.



#### MOLLA E FASCETTE



#### ADATTATORE



### POIRE À CARBURANT

#### POIRE À CARBURANT

- Élastomères thermoplastiques injectés
- Résistant à l'alcool et aux rayons UV.



#### TUYAU CARBURANT

- Universelle.
- Tuyau résistant à l'alcool.



#### RESSORT ET COLLIER

#### RACCORD COUPLEUR

**RECMAR®**

## 2

### FUEL HOSE

#### FUEL HOSE

##### CARBUPOMP/10NL

- Rubber Hose suitable for loading mineral oils, diesel and unloaded fuel

### MANGUERA CARBURANTE

#### MANGUERA CARBURANTE

- De goma para diesel y gasolina sin plomo.  
- Refuerzos textiles internos.  
- Muy flexible.  
- Contenido aromático 50%.

### TUBO DI CARBURANTE

#### TUBO DI CARBURANTE

- In gomma per diesel e benzina senza piombo.  
- Tessuto interno rinforzato.  
- Molto flessibile.

### TUYAU DU CARBURANT

#### TUYAU DU CARBURANT

- En caoutchouc pour diesel et essence sans plomb.  
- Tissu intérieur renforcé.  
- Très flexible.

REF	Ø						
GS35031	6 mm 1/4"	10 bar	50 mm	-20°C → 80°C	50 m	0,26 kg/m	ISO R1307
GS35032	8 mm 5/16"	10 bar	65 mm		50 m	0,27 kg/m	

- Fuel resistant thermo-plastic formulation with 2 spiral reinforcement provides excellent bendability and resistance to UV, aging and permeation by gasoline/petrol and diesel, including alcohol blends.

- Manguera para líneas de combustible.  
- Refuerzo termoplástico que le permite excelente flexibilidad y resistencia a los rayos UV.  
- Resistente al alcohol.

- Tubi per il condotto del carburante.  
- Rinforzo termoplastico che gli permette un'eccellente flessibilità e resistenza ai raggi UV.  
- Resistente alle miscele di alcool.

- La formulation thermoplastique avec 2 renforts en spirale offre une excellente flexibilité et résistance aux UV, y compris les mélanges d'alcool.

REF	Ø						
TRI305-0566	8 mm 5/16"	12 bar	63 mm	-20°C → 100°C	15 m	1	SAEJ 1527 ISO-8469 B1
TRI305-0386	10 mm 3/8"		102 mm		15 m	1	



## 3

### FUEL TANK COMPONENTS & CONNECTORS

#### FUEL TANK CONNECTOR BRASS

REF		
REC90700	1/4" NPT	1

- To connect two motors to a single tank, or vice versa.

REF		
REC90701	1/4" NPT	1

#### THRU HULL

- For bulkhead up to 12 mm.  
- Made in machined brass.

REF		
REC90704	3/8"	1

#### NON-RETURN VALVE

- In-Line non-return valve for fuel pipes.

REF		
GS31003	8 mm	1
GS31004	10 mm	1
GS31005	12 mm	1

### COMPONENTES TANQUE Y CONECTORES

#### CONECTOR DE DEPÓSITO DE LATÓN

- Para conectar dos motores a un sólo depósito, o viceversa.

#### PASAMAMPAROS

- Para atravesar mamparos de hasta 12 mm.  
- Fabricado en latón.

#### VÁLVULA ANTIRETORNO

- Válvula antiretorno para líneas de combustible y ventilación.

### COMPONENTI SERBATOIO E CONETTORI

#### ATTACCO SERBATOIO IN OTTONE

- Per collegare due motori a un singolo serbatoio o viceversa.

#### PASSASCAFO

- Per attraversare paratie fino a 12 mm.  
- Fabricato in ottone.

#### VALVOLA ANTI-RITORNO

- Valvola anti-ritorno per linee di combustibile e ventilazione.

### COMPOSANTS ET CONNECTEURS DU RÉSERVOIR

#### RACCORDS DE RÉSERVOIR EN LAITON

**RECMAR®**

**RECMAR®** MADE IN THE USA

**RECMAR®** MADE IN THE USA

#### CLAPET ANTI-RETOUR

- Clapet anti-retour pour les conduites de carburant et de ventilation.



**GOLDENSHIP**

**FUEL VALVE**

- Three ways fuel valve.
- Made in brass
- with 2 holes flange.
- To connect 2 tanks to one single feeding pipe.

**VÁLVULA DE COMBUSTIBLE**

- Válvula manual a 3 vías, para combustible.
- Fabricada en latón pulido.
- Montaje mediante soporte con 2 agujeros.
- Para conectar 2 depósitos a un solo motor.

**VALVOLA CARBURANTE**

- Valvola manuale a 3 uscite, per carburante.
- Fabricata in ottone.
- Fissare mediante supporto con 2 fori.
- Per collegare 2 serbatoi a un solo motore.

**VANNE POUR CARBURANT**

- Vanne manuelle 3 voies, pour carburant.
- Fabriqué en laiton poli.
- Montage par support à 2 trous
- Pour connecter 2 réservoirs à un seul moteur.



REF			
GS31010	1/4"	10 mm	1
GS31011	3/8"	10-13 mm	1

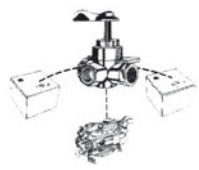

- Two ways fuel valve.
- Made in brass.

- Válvula manual a 2 vías.
- Fabricada en latón pulido.

- Valvola manuale a 2 uscite.
- Fabricata in ottone.

- Vanne manuelle 2 voies
- Fabriqué en laiton poli.

REF			
GS31006	1/4" NPT	1/4" NPT	1

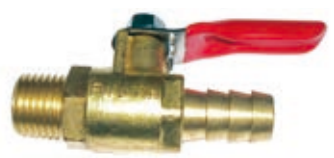

- Manual and remote fuel valve.
- Made in chrome plated brass.
- Can be mounted in line with hose or directly on gasoline tanks.

- Válvula manual para combustible.
- Fabricada en latón cromado con racors.
- Puede montarse en línea o desmontando el soporte, incorporarla directamente al depósito.

- Valvola manuale per carburante.
- Fabricata in ottone cromato con raccordo.
- Si puo' montare in linea o smontando il supporto, incorporarla direttamente al serbatoio.

- Vanne manuelle pour le carburant.
- Fabriqué en laiton chromé avec raccords.
- Elle peut être montée en ligne ou en l'intégrant directement dans le réservoir sans son support.

REF			
GS31012	1/4"	10 mm	1



**FUEL ELECTRO-VALVE**

- Fuel cut off electrovalve 12V with manual cock.
- Includes racors for flexible hose and cooper tube.

**ELECTROVÁLVULA DE COMBUSTIBLE**

- Incluye conexiones para mangueras flexibles y para tubo de cobre.
- Accionamiento a 12V y manual.

**ELETTROVALVOLA CARBURANTE**

- Include raccordi per tubo flessibile e per tubi di rame.
- Avviamento a 12V e manuale.

**ÉLECTROVANNE POUR CARBURANT**

- Comprend des connexions pour tuyaux flexibles et tube en cuivre.
- Entraînement 12V et manuel.

REF						
GS31013	12V	100l/h	1/4"	8-10 mm	1	CE 94/25 (EN28846) R.I.Na.DIP 61697

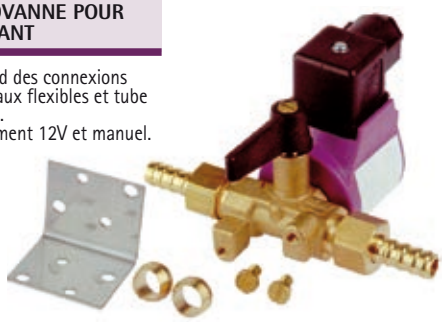

**4**

**FUEL FILTERS AND ELEMENTS**

**FILTROS DE COMBUSTIBLE Y ELEMENTOS**

**FILTRI BENZINA E RACCORDI**

**FILTRE A ESSENCE ET CARTOUCHE DE RECHANGE**

**WATER SEPARATING FUEL FILTER**

**FILTRO COMBUSTIBLE SEPARADOR DE AGUA**

**FILTRO SEPARATORE ACQUA-BENZINA**

**FILTRE À ESSENCE, SÉPARATEUR D'EAU**

REF	MICRON			
PAF40-0701000EI	10	100 l/h	INCLUDED Ø 6 mm x 2	- 70 hp



**WATER SEPARATING FUEL FILTER WITH BRACKET**

**FILTRO COMB. SEPARADOR DE AGUA CON BRACKET**

**FILTRO SEPARATORE ACQUA-BENZINA CON BRACKET**

**FILTRE À ESSENCE, SÉPARATEUR D'EAU AVEC BRACKET**



FILTER	REC120	REC320-01	REC320-02	REC490R	REC660R	RECOBFILALU	RECOBFILTER
Max. Flow rate	114 LPH (30GPH)	227 LPH (30GPH)	227 LPH (30GPH)	341 LPH (90GPH)	341 LPH (90GPH)		227 LPH (30GPH)
Filter (2 micron)		RECS3228SUL	RECS3228SUL	RECS3228SUL			RECS3220SUL
Filter (10 micron)	RECS3240	RECS3227	RECS3228TUL	RECS3227	RECS3232		RECS3213
Filter (28 micron)							
Center threads	M18 X 1.5	1" - 14	1" - 14	1" - 14	1" - 14		11/16" - 16
Port size	1/4" - 18 NPTF	1/4" - 18 NPTF	1/4" - 18 NPTF	3/8" - 18 NPTF	3/8" - 18 NPTF		1/4" - 18 NPTF
Bracket material	Aluminium	Aluminium	Aluminium	Aluminium	Aluminium	Aluminium	Aluminium Plastic
Height	16.5 cm	23.9 cm	22.9 cm	25.1 cm	27.9 cm		23.6 cm
Width	8.1 cm	10.2 cm	10.2 cm	11.4 cm	10.7 cm		10.2 cm
Depth	8.1 cm	10.2 cm	10.2 cm	12.2cm	11.4 cm		10.2 cm
Weight	0.5 kg	0.9 kg	0.9 kg	1.2 kg	1.4 kg		0.9 kg
Clean pressure drop	0.01 bar	0.04 bar	0.04 bar	0.07 bar	0.04 bar		0.04 bar
Max. Working pressure	0.5 bar	0.5 bar	0.5 bar	0.5 bar	0.5 bar		0.5 bar
Service clearance	2.5 cm	2.5 cm	2.5 cm	2.5 cm	2.5 cm		2.5 cm
Ambient temp range	-40° to +124°C	-40° to +124°C	-40° to +124°C	-40° to +124°C	-40° to +124°C		-40° to +124°C
Max. Fuel temperature	88° C	88° C	88° C	88° C	88° C		88° C



**ELEMENT+ BOWL**



REC120EB	REC320-01EB	REC320-02EB	REC320-01EB REC490R-EB	REC660R-EB	RECOBEB RECB32013
----------	-------------	-------------	---------------------------	------------	----------------------

**BOWL**



RECRK30475	RECRK30475	RECRK30475	RECRK30475
------------	------------	------------	------------



INCLUDED

**ELEMENT**

**ELEMENTO**

**ELEMENTO**

**CARTOUCHE**

**NEW**



REF	MICRON		
1 REC25000 1 REC25010 1 RECOBBRACKET 1 REC25040	10	6 <sup>1/64"</sup> = 15,3 cm	
1 REC24942	10	4 <sup>7/16"</sup> = 11 cm	
2 RACPF5510	10	4 <sup>7/16"</sup> = 11 cm	
1 REC35-802893Q01	10	3 <sup>3/4"</sup>	
3 RM35-802893Q	10	3 <sup>3/4"</sup>	
1 REC35-802893Q	25	3 <sup>3/4"</sup>	
1 REC855686	28	4 <sup>7/16"</sup> = 11 cm	



**INFO**  
INSTAL.  
P. 9

REF  
RECYS-225-15



RECOBIFILALUTWIN	REC90798-1M740	REC90798-1M745	REC24950	REC24952	
227 LPH (30GPH)	227 LPH (30GPH)	114 LPH (30GPH)	189 LPH (50GPH)	189 LPH (50GPH)	Max. Flow rate
RECS3213	REC90794-46913	REC90794-46914	REC855686	REC24942	Filter (2 micron)
11/16" - 16			11/16" - 16	11/16" - 16	Filter (10 micron)
1/4" - 18 NPTF	1/2" - 18 NPTF		1/4" - 18 NPTF	1/4" - 18 NPTF	Filter (28 micron)
Aluminium	Aluminium	Plastic	Aluminium	Aluminium	Center threads
23.5 cm	22.5 cm	16.5 cm	22.9 cm	22.9 cm	Port size
22 cm	9.3 cm	6 cm	10.2 cm	10.2 cm	Bracket material
10.2 cm	12.8 cm	6.9 cm	10.2 cm	10.2 cm	Height
1.9 kg	0.9 kg	0.5 kg	0.9 kg	0.9 kg	Width
0.04 bar	0.01 bar	0.04 bar	0.04 bar	0.04 bar	Depth
0.5 bar	0.5 bar	0.5 bar	0.5 bar	0.5 bar	Weight
					Clean pressure drop
					Max. Working pressure
					Service clearance
-40° to +124°C	-40° to +124°C	-40° to +124°C	-40° to +124°C	-40° to +124°C	Ambient temp range
88° C	88° C	88° C	88° C	88° C	Max. Fuel temperature
	ISO 14001 IATF 16949 CE	ISO 14001 IATF 16949 CE			 ELEMENT+ BOWL
					 BOWL
RECRK30475					
	Ø 8 mm x 1 Ø 10 mm x 1	Ø 6 mm x 2			INCLUDED

BRACKET				SUPPORTO				TÊTE DE FILTRE À ESSENCE			
REF											
1 REC25000	11/16" - 16	1/4" - 18 NPTF	AL								
2 REC25010	11/16" - 16	1/4" - 18 NPTF	INOX   SS AISI316								
4 RECOBBRACKET	11/16" - 16	1/4" - 18 NPTF	Plastic								
1 REC25020	11/16" - 16	3/8" - 18 NPTF	AL								
2 REC25030	11/16" - 16	3/8" - 18 NPTF	INOX   SS AISI316								
3 REC25040	11/16" - 16	1/4" - 18 NPTF	AL								

NEW



**WATER SEPARATING FUEL FILTER**

**FILTRO COMBUSTIBILE  
SEPARADOR DE AGUA**

**FILTRO SEPARATORE ACQUA-  
BENZINA**

**FILTRE À ESSENCE, SÉPARATEUR  
D'EAU**

**RACOR.**



FILTER	RAC120R-RAC-01	RAC320R-RAC-01	RAC320R-RAC-03	RAC320R-INOX-01	RAC490R-RAC-01	RAC320R-RAC-02	RAC660R-RAC-01
Max. Flow rate	114 l/h (30GPH)	340 l/h (60 gph)	340 l/h (60 gph)	340 l/h (60 gph)	341l/h (90GPH)	340 l/h (60 gph)	341l/h (90GPH)
Filter (10 micron)	<b>RACS3240</b>	<b>RACS3213</b>	<b>RACS3213</b>	<b>RACS3213</b>	<b>RACS3227</b>	<b>RAC3220TUL</b>	<b>RAC3220TUL</b>
Center threads	M18 X 1.5	1" 1/4	1" 1/4	1" 1/4	1" 1/4	1" 1/4	
Port size	1/4" - 18 NPTF	1/4" - 18 NPTF	1/4" - 18 NPTF	1/4" - 18 NPTF	3/8" - 18 NPTF		1/4"-18 NPTF 3/8"-18 NPTF 1/2"-14 NPTF
Bracket material		Aluminium	Plastic	INOX   SS AISI316			
Height	16.5 cm	23.8 cm	23.8 cm	23.8 cm	23.8 cm	23.8 cm	27.9 cm
Width	8.1 cm	10.2 cm	10.2 cm	10.2 cm	10.2 cm	10.2 cm	10.7 cm
Depth	8.1 cm	10.2 cm	10.2 cm	10.2 cm	10.2 cm	10.2 cm	11.4 cm
Weight	0.5 kg	0.9 kg	0.9 kg	0.9 kg	0.9 kg	0.9 kg	1.4 kg
Clean pressure drop	0.15 PSI	0.61 PSI	0.61 PSI	0.61 PSI	0.61 PSI	0.61 PSI	0.61 PSI
Max.Working pressure	7 PSI	7 PSI	7 PSI	7 PSI	7 PSI	7 PSI	7 PSI
Ambient temp range	-40° to +124°C	-40° to +124°C	-40° to +124°C	-40° to +124°C	-40° to +124°C	-40° to +124°C	-40° to +121°C

ELEMENT+ BOWL



RACB32013

RACB32013

RACB32013

**ELEMENT**

**ELEMENTOS DE RECAMBIO**

**ELEMENTI DI RICAMBIO**

**CARTOUCHE DE RECHANGE**

REF	
RACS3240	RAC120R-RAC-01
RACS3227	RAC490R-RAC-01
RACS3213	RAC320R-RAC-01 RAC320R-RAC-01 INOX RAC320R-RAC-03
RACS3214	Johnson & Evinrude
RACS3228UL	RAC320R-RAC-02, bracket RACOR



**COMPLET FUEL FILTER WITH  
TRANSPARENT BOWL**

**FILTRO DECANADOR DE  
COMBUSTIBLE COMPLETO CON  
VASO TRASPARENTE**

**FILTRO DI DECANAZIONE  
BENZINA COMPLETO CON  
VASCHETTA TRASPARENTE**

**FILTRE SÉPARATEUR D'ESSENCE  
COMPLET**

REF				
RAC23299-10	RAC23289-10	130 HP	H2	H4

**RACOR.**



CONSULT SPECIFIC FILTERS FOR A BRAND IN HIS CATALOG.

CONSULTAR FILTROS ESPECÍFICOS PARA UNA MARCA EN SU CATÁLOGO.

CONSULTA I FILTRI SPECIFICI PER UN MARCHIO NEL SUO CATALOGO.

CONSULTER LES FILTRES SPÉCIFIQUE À UNE MARQUE DANS LEUR CATALOGUE.

**AIR SEPARATING FUEL FILTER  
DISEL-GAS**

**FILTRO COMBUSTIBLE SEPARADOR  
DE AIRE. GAS-DIESEL**

**FILTRO SEPARATORE ARIA-  
BENZINA. GAS-DIESEL**

**FILTRE À ESSENCE, SÉPARATEUR  
D'AIR. GAS-DIESEL**

REF				
RACLG100	17 CFM (481 l/m)	5/8"	2.4 PSI (0.17 bar)	24.9 x Ø10.2 cm

**RACOR.**



**IN-LINE FILTER**

**FILTRO PARA MONTAJE EN  
LÍNEA**

**FILTRO PER MONTARE IN LÍNEA**

**FILTRE POUR MONTAGE EN  
LIGNE**

REF					
1 REC90799			5/8"	5/8"	plastic
REC90790		6-8 mm			plastic
2 REC31001	50 l/h	6-8 mm			plastic
3 REC31002	150 l/h	8-10 mm			plastic
REC40145			1/4"	1/4"	
4 REC40155			5/16"	5/16"	plastic
REC40165			3/8"	3/8"	
REC40135			5/16"	3/8"	
5 GS30435		6, 8, 10 mm			metal + crystal



Removable bowl      Cubeta extraíble      Vasca estraibile      Seau amovibil

REF	
REC90798	6-8 mm



**RACOR MADE IN BRASS**

**RACOR DE LATÓN**

**RACCORDO IN OTTONE**

**RACCORD EN LAITON**

REF			
GS31065	1/4"	3/8" 9.5 mm	1
GS31166	1/4"	5/16" 7.9 mm	2
GS31245	1/4"	1/4" 6.4 mm	
GS31155	3/8"	3/8" 9.5 mm	2
GS31156	3/8"	5/16" 7.9 mm	2
GS31157	3/8"	1/4" 6.4 mm	2
REC22-00874	3/8"	3/8" 9.5 mm"	
GS31066	1/4"	5/16" 7.9 mm	2
GS30111	1/4"	10	
GS31067	1/4"	3/8" 9.5 mm	2
REC22-00842	1/4"	1/4" 6.4 mm	2
REC22-00845	1/4"	5/16" 7.9 mm	2
GS30112	3/8"	12	



REF		
BRA125-1/4X1/4	1/4"	1/4"
BRA125-5/16X3/8	5/16"	3/8"
BRA125-3/8X3/8	3/8"	3/8"
BRA125-3/8X1/2	3/8"	1/2"
BRA125-1/2X3/8	1/2"	3/8"
BRA125-1/2X1/2	1/2"	1/2"
BRA125-5/8X3/8	5/8"	3/8"
BRA125-5/8X3/4	5/8"	3/4"
RAC1/2X20	3/4"	1/2"
BRA125-3/4X3/4	3/4"	3/4"
BRA125-1X3/4	1"	3/4"





# Electric System

ELECTRIC SYSTEM

SISTEMA ELÉCTRICO

SISTEMA ELETTRICO

SYSTÈME ÉLECTRIQUE

## 1

### FUSES

#### ATC

Ref	⚡	(mm)	📱
1 GS11501	3 A	19 x 19	5
2 GS11502	4 A	19 x 19	5
3 GS11503	10 A	19 x 19	5

### FUSIBLE

#### ATC

Ref	⚡	(mm)	📱
4 GS11504	15 A	19 x 19	5
5 GS11505	20 A	19 x 19	5
6 GS11506	30 A	19 x 19	5

### FUSIBILE

#### ATC



### FUSIBLE

#### ATC



With illuminated LED when blown.

Ref	⚡	(mm)	📱
1 BS5291	3 A	19 x 19	2
2 BS5292	5 A	19 x 19	2
3 BS5293	7,5 A	19 x 19	2
4 BS5294	10 A	19 x 19	2
5 BS5295	15 A	19 x 19	2

Con LED indicador de fundido.

Ref	⚡	(mm)	📱
6 BS5296	20 A	19 x 19	2
7 BS5297	25 A	19 x 19	2
8 BS5298	30 A	19 x 19	2
9 BS5299	40 A	19 x 19	2

Con indicatore LED.



Avec indicateur LED.

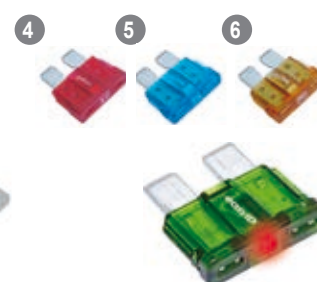

#### ATM

Ref	⚡	(mm)	📱
AM603905	5 A	11 x 16	2
AM603910	10 A	11 x 16	2
AM603915	15 A	11 x 16	2
AM603920	20 A	11 x 16	2
AM603930	30 A	11 x 16	2

#### ATM

#### ATM



#### ATM



#### MAXI

Tin plated connector blades for corrosion resistance.

Ref	⚡	📱
BS5138	30 A	1
BS5139	40 A	1
BS5140	50 A	1
BS5141	60 A	1
BS5142	70 A	1
BS5143	80 A	1

#### MAXI

Contactos estañados para resistir a la corrosión.

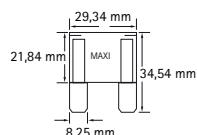

#### MAXI

Connettori stagni per resistere alla corrosione.



#### MAXI

Contacts étamés pour résister à la corrosion.



**IGNITION KILL SWITCHES**

**IGNITION KILL SWITCHES**

-Emergency and stop switch.  
-Isolates circuits on dual units to prevent feedback.



THKS-1 THKS-12 THL-4

**DESCONECTADOR DE SEGURIDAD**

**DESCONECTADOR DE SEGURIDAD**

-Interruptor de encendido para motores.  
-Aísla los circuitos en unidades dobles para prevenir el retorno al alternador.

**INTERRUPTORE DI STOP**

**INTERRUPTORE DI STOP**

-Interruttore di accensione per motori.  
-Isola i circuiti in doppie unità per prevenire il ritorno all'alternatore.



**INTERRUPTEUR DE SÉCURITÉ**

**INTERRUPTEUR DE SÉCURITÉ**

-Contacteur d'allumage pour moteurs.  
-Isolez les circuits en unités doubles pour empêcher le retour à l'alternateur.



KIT	
1 REC40970	4 REC40990
2 REC40971	5 REC40991
3 REC40992	6 REC8M0092849



**RECMAr®**

**KILL SWITCHES KEYS**

**KITS LLAVES**

**KIT CHIAVI**

**KITS DE CLÉS**

**REF**

Johnson / Evinrude  
OMC  
Mercury  
Yamaha  
Honda  
Suzuki  
Tohatsu

REC28850



**RECMAr®**

**IGNITION STARTER SWITCHES WITH RETURN**

**BRASS**

**LLAVE DE ARRANQUE CON RETROCESO**

**LATÓN**

**CHIAVE DI AVVIAMENTO CON RITORNO**

**OTTONE**

**CONTACTEUR À CLÉ AVEC RETOUR**

**LAITON**

REF	A		
1 GS11150	28 mm	3, 15A 12V	3
2 REC41010		3	Off-Ignition-Star
REC41020		4	

**RECMAr®**

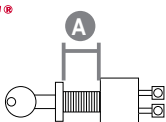



**IN PLASTIC WITH RUBBER CAP PROTECTOR**

**PLÁSTICO CON FRONTAL PROTECTOR DE GOMA**

**IN PLASTICA CON PARTE FRONTALE IN GOMMA**

**PLASTIQUE AVEC FAÇADE DE PROTECTION EN CAOUTCHOUC.**

REF	A		
1 REC856659	15 mm	3	3
2 REC386545		5	Off-Ignition-Star
3 REC41030	15 mm 5/8"	7	4
REC41040	6 mm 1/4"	7	Acc-Off-Ignition-Star

**RECMAR®**

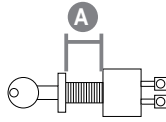



**PLASTIC**

**PLÁSTICO**

**PLASTICA**

**PLASTIQUE**

REF	A		
1 REC41050	15 mm 5/8"	6	3
2 REC87-802136	6 mm 1/4"	6	Off-Ignition-Star
3 REC87-88107A5		6	

**RECMAR®**

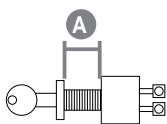

**4**

**SENDERS & ALARMS**

**SENSORES Y ALARMAS**

**SENSORI E ALLARMI**



**SONDES ET ALARMES**

**OIL PRESSURE SENDER**

**SENSOR PRESIÓN ACEITE**

**SENSORI PRESSIONE OLIO**

**SONDE DE PRESSION D'HUILE**

REF				
REC8M0068784	80 PSI	1/8" NPTF	USA	
FA90519	100 PSI	1/8" NPTF	USA	

**RECMAR®**



**COMPLETE TEMPERATURE & OIL PRESSURE WARNING KIT**

**KIT TEMPERATURA Y PRESIÓN DE ACEITE CON ALARMA**

**KIT TEMPERATURA E PRESSIONI DELL'OLIO CON ALLARME**

**KIT SONDE TEMPÉRATURE ET PRESSION D'HUILE**

REF
REC41400

**RECMAR®**



**TEMPERATURE SENDER**

**SENSOR TEMPERATURA**

**SENSORI TEMPERATURA**

**SONDE DE TEMPERATURE**

REF			
REC97258A1	1/2" = 14 NPTF		
FA90401	1/8"	USA	

**RECMAR®**



REF

AM603905	66	GS31010	61	GS41284	50	OCEM000V	57	PRE250007	39
AM603910	66	GS31011	61	GS41285	50	OCEM005	57	PRE250008	39
AM603915	66	GS31012	61	GS41286	50	OCEM00V	57	PRE250009	39
AM603920	66	GS31013	61	GS41287	50	OCEM025	57	PRE250010	39
AM603930	66	GS31065	65	GS73069	56	OCEM02V	57	PRE250011	39
BRA125-1/2X1/2	65	GS31066	65	GS73119	7	OCEM10S	57	PRE250012	39
BRA125-1/2X3/8	65	GS31067	65	GS73120	7	OCEM10V	57	PRE250013	39
BRA125-1/4X1/4	65	GS31090	59	GS73122	7	OCEM15S	57	PRE250014	39
BRA125-1X3/4	65	GS31095	59	GS73130	53	OCEM15V	57	PRE250015	39
BRA125-3/4X3/4	65	GS31096	59	GS73131	53	OCEM20S	57	PRE250016	39
BRA125-3/8X1/2	65	GS31097	59	GS73132	53	OCEM25S	57	PRE260303	38
BRA125-3/8X3/8	65	GS31099	59	GS73133	53	OCEM30S	57	PRE260304	38
BRA125-5/16X3/8	65	GS31155	65	GS73135	56	OCEM35S	57	PRE30050	49
BRA125-5/8X3/4	65	GS31156	65	GS73136	56	OCEM40S	57	PRE308650	45
BRA125-5/8X3/8	65	GS31157	65	GS73138	57	OCEM45S	57	PRE315008	39
BS5138	66	GS31166	65	GS73139	57	OCEM50S	57	PRE315009	39
BS5139	66	GS31183	59	GS90001	32	OCEMA0741	57	PRE315010	39
BS5140	66	GS31187	59	GS90002	32	OCEMA0742	57	PRE315011	39
BS5141	66	GS31245	65	GS90003	32	OCEMA0743	57	PRE315012	39
BS5142	66	GS331980	45	GS90004	32	OCEMA0744	57	PRE315013	39
BS5143	66	GS332010	45	GS90005	32	OCEMA0745	57	PRE315014	39
BS5291	66	GS35031	60	GS90006	32	OCEMA0746	57	PRE315015	39
BS5292	66	GS35032	60	GS90007	32	OCEMA0751	57	PRE315016	39
BS5293	66	GS40010	49	GS90008	32	OCEMA0752	57	PRE315017	39
BS5294	66	GS41035	42	GS90009	32	OCEMA0753	57	PRE315018	39
BS5295	66	GS41037	42	GS90010	32	OCEMA0754	57	PRE315019	39
BS5296	66	GS41038	43	GS90011	32	OCEMA0755	57	PRE315020	39
BS5297	66	GS41039	43	GS90012	32	OCEMA0756	57	PRE31507	45
BS5298	66	GS41040	41	GS90013	32	OCEMA0757	57	PRE31508	45
BS5299	66	GS41041	41	GS90015	32	OCEMA0758	57	PRE31509	45
CMC12525	56	GS41042	41	GS90019	32	OCEMA0759	57	PRE31510	45
CMC13001Q	54	GS41047	43	GS90020	32	OCEMA0759L	57	PRE31511	45
CMC13002Q	54	GS41048	43	GS90021	32	OCEM0759	57	PRE31512	45
CMC13022Q	56	GS41049	43	GS90022	32	OCEM0759L	57	PRE31513	45
CMC20122Q	56	GS41052	43	GS90023	32	OCEM0759L	57	PRE31514	45
CMC51127	56	GS41053	42	GS90024	32	OCEM0759L	57	PRE31515	45
CMC51207	56	GS41054	42	GS90025	32	OCEM0759L	57	PRE31516	45
CMC51290	56	GS41056	43	GS90026	32	OCEM0759L	57	PRE31799	45
CMC51300	56	GS41059	41	GS90027	32	OCEM0759L	57	PRE31916	45
CMC52100D	54	GS41060	43	GS90029	32	OCEM0759L	57	PRE31917	45
CMC6044	56	GS41062	41	GS90030	32	OCEM0759L	57	PRE3300C05	44
CMC6045	56	GS41063	43	GS90031	32	OCEM0759L	57	PRE3300C06	44
CMC6077	56	GS41065	41	GS90032	32	OCEM0759L	57	PRE3300C07	44
CMC61001Q	54	GS41066	41	GS90034	32	OCEM0759L	57	PRE3300C08	44
CMC65001Q	54	GS41068	41	GS90037	32	OCEM0759L	57	PRE3300C09	44
CMC65501	54	GS41069	41	GS90038	32	OCEM0759L	57	PRE3300C10	44
CMC7050D	56	GS41070	43	GS90039	32	OCEM0759L	57	PRE3300C11	44
CMC7186	56	GS41071	43	GS90040	32	OCEM0759L	57	PRE3300C12	44
CMC7342	56	GS41072	43	GS90041	32	OCEM0759L	57	PRE3300C13	44
CMC7493	56	GS41073	43	GS90042	32	OCEM0759L	57	PRE3300C14	44
CRA902171	12	GS41074	44	GS90043	32	OCEM0759L	57	PRE3300C15	44
CRA902175	13	GS41075	43	GS90049	32	OCEM0759L	57	PRE3300C16	44
CRA904633	9	GS41077	43	GS90050	32	OCEM0759L	57	PRE3300C17	44
CRA921023	13	GS41079	43	GS90051	32	OCEM0759L	57	PRE3300C18	44
CRA935154	11	GS41080	42	GS90052	32	OCEM0759L	57	PRE3300C19	44
CRA944595	11	GS41081	42	GS90053	32	OCEM0759L	57	PRE3300C20	44
CRA946331	9	GS41082	42	GS90054	32	OCEM0759L	57	PRE3300C21	44
CRA952343	11	GS41083	42	GS90056	32	OCEM0759L	57	PRE3300C22	44
FA90401	68	GS41084	42	GS90057	32	OCEM0759L	57	PRE3300C23	44
FA90519	68	GS41085	42	GS90058	32	OCEM0759L	57	PRE3300C24	44
GE15210	28	GS41089	43	GS90059	32	OCEM0759L	57	PRE3300C25	44
GE21204	28	GS41091	43	GS90060	32	OCEM0759L	57	PRE3300C26	44
GE22001	28	GS41095	43	GS90061	32	OCEM0759L	57	PRE3300C27	44
GE22027	29	GS41096	43	GS90062	32	OCEM0759L	57	PRE3300C28	44
GE22239	29	GS41097	43	GS90063	32	OCEM0759L	57	PRE3300C29	44
GE22254	29	GS41098	42	GS90064	32	OCEM0759L	57	PRE3300C30	44
GEGC15	27	GS41110	51	GS90066	32	OCEM0759L	57	PRE3300C31	44
GLE11314-12S	46	GS41114	41	GS90067	32	OCEM0759L	57	PRE3300C32	44
GLE11314-24S	46	GS41115	51	GS90068	32	OCEM0759L	57	PRE3300C33	44
GLE11419-SGTR-P2B	46	GS41117	43	GS90069	32	OCEM0759L	57	PRE3300C34	44
GLE11419-TWTR-6B	46	GS41118	42	GS90072	32	OCEM0759L	57	PRE3300C35	44
GLE11420-SGTR-UC	46	GS41119	50	GS90073	32	OCEM0759L	57	PRE3300C36	44
GLE11420-TWTR-C	46	GS41122	50	GS90074	32	OCEM0759L	57	PRE3300C38	44
GLE11600-02100	46	GS41123	50	GS90075	32	OCEM0759L	57	PRE3300C40	44
GLE11600-0210	46	GS41127	51	GS90076	32	OCEM0759L	57	PRE3300C42	44
GLE11600-02-120	46	GS41131	51	GS90077	32	OCEM0759L	57	PRE3300C44	44
GLE11600-0220	46	GS41134	51	GS90090	28	OCEM0759L	57	PRE3300C46	44
GLE11600-0230	46	GS41135	51	GS90092	28	OCEM0759L	57	PRE3300C48	44
GLE11600-0240	46	GS41136	51	GS98011	43	OCEM0759L	57	PRE3300C50	44
GLE11600-0260	46	GS41137	51	LOC242	36	OCEM0759L	57	PRE331125	45
GLE11600-0280	46	GS41140	51	LOC243	36	OCEM0759L	57	PRE331538	45
GLESA2A-1E-OSBD-TR12	46	GS41141	51	LOC2701	36	OCEM0759L	57	PRE336174	45
GLESA2A-1E-OSBD-TR24	46	GS41143	51	LOC480	36	OCEM0759L	57	PRE36468	49
GLESA2A-2E-OSBD-TR12	46	GS41144	51	LOC5075	37	OCEM0759L	57	PRE370046	39
GLESA2A-2E-OSBD-TR24	46	GS41145	51	LOC55	37	OCEM0759L	57	PRE370613	39
GS11150	67	GS41147	51	LOC577	36	OCEM0759L	57	PRE370618	39
GS11501	66	GS41160	52	LOC5922	37	OCEM0759L	57	PRE370619	39
GS11502	66	GS41161	52	LOC7039	37	OCEM0759L	57	PRE370621	39
GS11503	66	GS41162	52	LOC7200	37	OCEM0759L	57	PRE370987	38
GS11504	66	GS41164	52	LOC8040	36	OCEM0759L	57	PRE500007	38
GS11505	66	GS41165	52	LUB10212	24	OCEM0759L	57	PRE500010	38
GS11506	66	GS41166	52	LUB11957	25	OCEM0759L	57	PRE500012	38
GS20080	26	GS41167	52	OCE100133	53	OCEM0759L	57	PRE500014	38
GS20081	26	GS41168	52	OCE100134	53	OCEM0759L	57	PRE509007	39
GS20082	26	GS41170	52	OCEH00A-S	58	OCEM0759L	57	PRE509008	39
GS20084	26	GS41173	43	OCEH00-S	58	OCEM0759L	57	PRE509009	39
GS20085	26	GS41179	43	OCEH00V	58	OCEM0759L	57	PRE509010	39
GS20151	26	GS41187	41	OCEH05-S	58	OCEM0759L	57	PRE509011	39
GS20198	8	GS41188	42	OCEH05V	58	OCEM0759L	57	PRE509012	39
GS20199	8	GS41207	44	OCEH10-S	58	OCEM0759L	57	PRE509013	39
GS30111	65	GS41208	42	OCEH10V	58	OCEM0759L	57	PRE509014	39
GS30112	65	GS41209	43	OCEH15-S	58	OCEM0759L	57	PRE509015	39
GS30350	8	GS41213	43	OCEH15V	58	OCEM0759L	57	PRE509016	39
GS30351	8	GS41220	43	OCEH20-S	58	OCEM0759L	57	PRE509017	39
GS30352	8	GS41221	43	OCEH25-S	58	OCEM0759L	57	PRE509018	39
GS30353	8	GS41231	43	OCEH30-S	58	OCEM0759L	57	PRE509019	39
GS30435	65	GS41232	43	OCEH35-S	58	OCEM0759L	57	PRE509020	39
GS31003	60	GS41280	50	OCEH40-S	58	OCEM0759L	57	PRE550008	39
GS31004	60	GS41281	50	OCEH45-S	58	OCEM0759L	57	PRE550009	39
GS31005	60	GS41282	50	OCEH50-S	58	OCEM0759L	57	PRE550010	39
GS31006	61	GS41283	50	OCEM000S	57	OCEM0759L	57	PRE550011	39

PRE550012	39	REC10W3050L	18	REC3905265	17	RECD168X0	15	RECZ16890	15
PRE550013	39	REC10W3050L	20	REC3905286	17	RECD36	5	RM35-802893Q	62
PRE550014	39	REC10W3003	18	REC3905397	17	RECD336C	5	RM85108974	23
PRE550015	39	REC10W3003	20	REC3906015	16	RECGREU1	20	RM91-37299Q2	24
PRE550016	39	REC10W3006	18	REC3906219	17	RECGREU12	20	RM92-858021QB1U6	21
PRE550017	39	REC10W3006	20	REC3906891	17	RECGREU12	24	RM92-858022QB1U3	21
PRE550018	39	REC10W40205L	18	REC3907103	17	RECGREU30	20	RM92-858023QB1U2	21
PRE550019	39	REC10W40205L	20	REC3907642	17	RECGREU35	20	RM92-858026QB1U6	21
PRE550020	39	REC10W4020L	18	REC3908405	17	RECGREU4	20	RM92-858027QB1U3	21
PRE550021	39	REC10W4020L	20	REC3909234	17	RECGREU4	24	RM92-858037QB1U3	21
PRE550022	39	REC10W4050L	18	REC3910127	17	RECGREU6	20	RM92-858064QB1U6	22
PRE550023	39	REC10W4050L	20	REC40135	65	RECH10-1/4	5	RM92-858065QB1U2	22
PRE550024	39	REC10W4003	18	REC40145	65	RECH10	5	RM92-858074QB1U12	23
PRE550025	39	REC10W4003	20	REC40155	65	RECHANDLEJO6HD	6	RM92-8M0086220U6	21
PRE550026	39	REC10W4006	18	REC40165	65	RECHC1322	40	RM92-8M0086221U3	21
PRE6300S05	45	REC10W4006	20	REC40-65	57	RECHC1402	40	RM92-8M0086223U6	22
PRE6300S06	45	REC110-230	57	REC40970	67	RECHC8114	40	RM92-8M0086224U3	22
PRE6300S07	45	REC1161995	22	REC40971	67	RECHC9416	40	RM92-8M0086226U6	22
PRE6300S08	45	REC120	62	REC40990	67	RECHH18C	40	RM92-8M0086227U3	22
PRE6300S09	45	REC120EB	62	REC40991	67	RECHH20C	40	RM92-8M0096794U3	22
PRE6300S10	45	REC12	5	REC40992	67	RECHH25C	40	RM92-8M0121960U12	22
PRE6300S11	45	REC15	5	REC41010	67	RECHH28C	40	RM92-8M0133985U4	22
PRE6300S12	45	REC15W40205L	18	REC41020	67	RECHS0B150	40	RM92-8M0133989U6	22
PRE6300S13	45	REC15W40205L	20	REC41030	68	RECHS0B350	40	SEA94000	53
PRE6300S14	45	REC15W4020L	18	REC41040	68	RECHS0B90	40	SEA94010	53
PRE6300S15	45	REC15W4020L	20	REC41050	68	RECHSPB250	40	SFPFH35003	26
PRE6300S16	45	REC15W4050L	18	REC41400	68	RECHT4430	40	SFPFH76503	26
PRE6300S17	45	REC15W4050L	20	REC490R	62	RECHT4431	40	SH3010-000	27
PRE6300S18	45	REC15W4003	18	REC490R-EB	62	RECHT4432	40	SH8050-305-426	25
PRE6300S19	45	REC15W4003	20	RECS119766	12	RECHT4433	40	SIE18-8004	59
PRE6300S20	45	REC16	5	RECS119902	12	RECHT4433	40	SIE18-8005	59
PRE6300S21	45	REC17	5	RECS119903	12	RECSO46U3	20	SIE18-8013	59
PRE6300S22	45	REC18	5	RECS5005	25	RECJO10	6	SIE18-8015	59
PRE6300S23	45	REC19	5	RECS5006	25	RECJO6HD	6	SOR102002	23
PRE6300S24	45	REC19876	10	RECS5007	25	RECJP5060R	55	SORI12045	23
PRE6300S25	45	REC20	5	RECS5133GF	26	RECKFW	5	SRJR2-1	53
PRE6300S26	45	REC21363429	21	RECS5133M	26	RECKFW	6	SRPR01	53
PRE6300S27	45	REC21363430	21	RECS5133S	25	RECKOCYL	6	SRSF	53
PRE6300S28	45	REC21687793	31	RECS5133S	26	RECKRW	6	SRSR2-1	53
PRE6300S29	45	REC21687796	31	RECS5133S	26	RECLUBE100U12	28	SRXR4	53
PRE6300S30	45	REC22-00842	65	RECS5134	12	RECLUBE101U12	29	SSP4206	9
PRE6300S31	45	REC22-00845	65	RECS515100	8	RECLUBE102U12	29	SSP4207	9
PRE6300S32	45	REC22-00874	65	RECS-9.8	57	RECLUBE200U12	28	SSP4213	9
PRE6300S33	45	REC22479638	21	RECSW40205L	18	RECLUBE201U12	29	SSP4600	9
PRE6300S34	45	REC22479642	21	RECSW40205L	20	RECLUBE300U3	30	SSPEL05	26
PRE6300S35	45	REC22-8M0001721	59	RECSW4003	18	RECLUBE301U6	28	SSPHB100K	9
PRE6300S36	45	REC22928971	47	RECSW4003	20	RECLUBE302U6	29	STA14808	29
PRE6300S38	45	REC22928974	48	RECSW4006	18	RECLUBEKIT	19	STA83900EUR	30
PRE6300S40	45	REC22928974CR	48	RECSW4006	20	RECLUBETHO01A	24	STA93008	29
PRE6300S42	45	REC22928976	48	REC650-24351-51	59	RECLUBETHU02	24	STA93016	29
PRE6300S44	45	REC22928976CR	48	REC660R	62	RECMAR-10MEL-00-00	62	STA93116	30
PRE6300S46	45	REC24942	62	REC660R-EB	62	RECMJ10PS	4	STA93664	30
PRE6300S48	45	REC24942	63	REC6E5-24351-51	59	RECMJ10PSWHEEL	4	STA93900	31
PRE6500C05	45	REC24950	63	REC70-100	57	RECNSCYL	5	STA93922	31
PRE6500C06	45	REC24952	63	REC70720	9	RECOBBRACKET	63	STA93932	31
PRE6500C07	45	REC25000	63	REC75W140U3	19	RECOBEB	62	STA94100	31
PRE6500C08	45	REC25010	63	REC75W140U3	20	RECOBFILALU	62	STA95616	27
PRE6500C09	45	REC25020	63	REC75W9020L	19	RECOBFILALUTWIN	63	TEC145	14
PRE6500C10	45	REC25030	63	REC75W9020L	20	RECOBFILTER	62	TEC218	13
PRE6500C12	45	REC25040	63	REC75W90U3	19	RECOOLGREENU3	27	TEC384	14
PRE6500C14	45	REC250TP	52	REC75W90U3	20	RECOOLYELLOWU3	27	TEC786	14
PRE6500C16	45	REC25-35	57	REC75W90U6	19	RECPIN4	10	TECDT8580	13
PRE6500C18	45	REC25W40205L	18	REC75W90U6	20	RECPIN4.5	10	TER320	37
PRE6500C19	45	REC25W40205L	20	REC80W9015L	19	RECPIN5	10	THAHJM-4DP	54
PRE6500C21	45	REC25W4003	18	REC80W9015L	20	RECPIN6	10	THAHJM-CMADP	56
PRE6500C23	45	REC25W4003	20	REC80W9050L	19	RECP3090R	55	THCB-1	52
PRE6500C25	45	REC25W4006	18	REC80W9050L	20	RECRK22628	9	THCB-2	52
PRE6500C27	45	REC25W4006	20	REC80W90U3	19	RECRK30475	62	THCB-2W	52
PRE6500C29	45	REC25W50205L	20	REC80W90U3	20	RECRK30475	63	THCB-4	52
PRE6500C31	45	REC25W5020L	18	REC80W90U6	19	RECS3213	62	THCB-4W	52
PRE6500C33	45	REC25W50U3	18	REC80W90U6	20	RECS3213	63	THCB-W	52
PRE6500C35	45	REC25W50U3	20	REC85122800	22	RECS3220SUL	62	THKS-12	67
PRE6500C37	45	REC25W50U6	18	REC855686	62	RECS3227	62	THKS-1	67
PRE6500C39	45	REC25W50U6	20	REC855686	63	RECS3228SUL	62	THL-4	67
PRE6500C41	45	REC28850	67	REC856659	68	RECS3228TUL	62	THISP-1	52
PRE6500C43	45	REC2TU3	18	REC87-802136	68	RECS3232	62	TRE1206MG	30
PRE6500C45	45	REC2TU3	20	REC87-88107A5	68	RECS3240	62	TRE1206MP	30
PRE6500C47	45	REC2TU6	18	REC8M0068784	68	RECSAE30U3	19	TRE1206MQ	30
PREMF33521	50	REC2TU6	20	REC8M0092849	67	RECSAE30U3	20	TRE1212MG	30
PREMF33581	50	REC308601	49	REC90095	8	RECSAE30U6	19	TRE1245E	31
PREMF34521	50	REC308602	49	REC90700	60	RECSAE30U6	20	TRI305-0386	60
PS114699	32	REC31001	65	REC90701	60	RECSPRINGJO6HD	6	TRI305-0566	60
PS4688	31	REC31002	65	REC90704	60	RECSR9	6	TXCHX8150P	48
PS4706	31	REC320-01	62	REC90790	65	RECSR9WHEEL	6	TXCHX8240P	48
PS4707	31	REC320-01EB	62	REC90794-46913	63	RECT11958	25	TXCHX8550P	47
RAC120R-RAC-01	64	REC320-02	62	REC90794-46914	63	RECT30190	24	TXCHX8553P	47
RAC12X20	65	REC320-02EB	62	REC90798-1M740	63	RECT30201	24	TXCHX8555P	47
RAC23289-10	64	REC330TP	52	REC90798-1M745	63	RECTOOL1	7	TXCHX8640P	48
RAC23299-10	64	REC35-802893Q01	62	REC90798	65	RECTOOL1GB	7	TXCHX8650P	48
RAC320R-INOX-01	64	REC35-802893Q	62	REC90799	65	RECTOOL3	10	TXCHX8652P	48
RAC320R-RAC-01	64	REC386545	68	REC90890-06820	11	RECTOOL4	10	TXCHX8740P	48
RAC320R-RAC-02	64	REC3901775	15	REC91-00001	8	RECTOOL5	10	TXCHX8850P	47
RAC320R-RAC-03	64	REC3902247	17	REC91-00002	8	RECTOOL6	10	TXCHX8852P	47
RAC3220TUL	64	REC3902250	17	REC91-00003	12	RECTOOL7	10	TXHO6820	40
RAC490R-RAC-01	64	REC3902358	17	REC91-37241	8	RECTOOL8	10	TXHO6821	40
RAC660R-RAC-01	64	REC3902407	17	REC91-859046Q3	9	RECTOOL9	10	TXHO6822	40
RACB32013	64	REC3902413	17	REC91-859046Q4	9	RECTOOL10	10	TXHO6823	40
RACLG100	65	REC3902417	17	REC91-895343T02	11	RECTOOLTRIM1	10	TXHA6802	40
RACPF5510	62	REC3902467	17	REC97258A1	68	RECTOOL2	10	TXHA6804	40
RACS3213	64	REC3902659	17	REC9.9-20	57	RECTOOLTRIM2	10	TXHA6806	40
RACS3214	64	REC3902864	17	RECATF3	19	RECTOOLTRIM3	10	TXHA6811	40
RACS3227	64	REC3902865	17	RECATFU3	20	RECTOOLTRIM4	10	YARCHA	7
RACS3228BUL	64	REC3902907	17	RECATFU6	19	RECTOOLTRIM5	10	ZARES2	7
RACS3240	64	REC3902931	17	RECATFU6	20	RECTOOLTRIM6	10		
REC004	12	REC3903008	17	RECAxonENEMO	15	RECTOOLTRIM7	10		
REC09401-11425	59	REC3903502	17	RECAxonENEMOPLUS	15	RECTOOLTRIM8	10		
REC09401-11425BULK	59	REC3903560	17	RECAxonEVOICE	15	RECTOOLTRIMKIT	10		
REC10W30205L	18	REC3904048	16	RECAxonEVOICESCREEN	15	RECTOOLTRIMKIT2	10		
REC10W30205L	20	REC3904277	17	RECB32013	62	RECWS3	6		
REC10W3020L	18	REC3905015	17	REC06591	15	RECS-225-15	62		
REC10W3020L	20	REC3905159	17	REC0117D0	15	RECS06590PC	15		

REF -&gt; OEM

P. 131

OEM -&gt; REF

P. 137

SUZUKI

# SUZUKI

## ENGINES

## MOTORES

## MOTORE

## MOTEURS



- 54 DF9.9, DF15 (2004-12)
- 55 DF9.9B, DF15A, DF20A (2013+)
- 56 DF25A, DF30A (2015+)
- 57 DF25V-TWIN (2006-15)
- 58 DF40, DF50 (1999-10)
- 59 DF40A, DF50A, DF60A (2010+)
- 60 DF70A, DF80A, DF90A, DF100B (2009+)
- 61 DF90, DF100, DF115 (2001-11)
- 62 DF100A, DF115A, DF140A (2012-21)
- 62 DF140 (2002-12)
- 63 DF100C, DF115B, DF140B (2022+)
- 64 **A** DF150, DF175 (2006-18) **B** DF150, DF175, DF200 (2019+)
- 66 **A** DF200, DF225, DF250 (2004-23) **B** DF250AP, DF300AP (2012+), DF300T/Z (2007-11)
- 68 DF300B, DF325A, DF350A (2018-23)
- 78 DT40C-W-G-X (1986-99)  
DTW-K1-KA (2001-04)

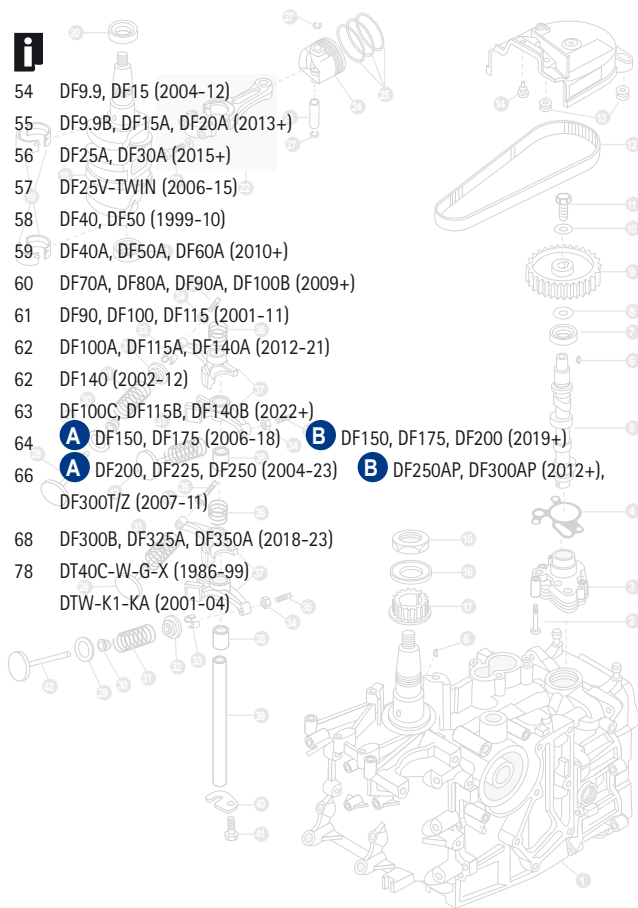

## DRIVES

## COLAS

## PIEDI

## EMBASES



- 88 DF4, DF5, DF6
- 90 DF8A/AR, DF9.9A/AR, DF9.9B, DF15A, DF20A
- 92 DF9.9, DF15
- 94 DF9.9B, DF15A, DF20A
- 96 DF20R, DF25R
- 98 DF25, DF30
- 100 DF40, DF50
- 102 DF40A, DF 50A, DF60A
- 104 DF60, DF70
- 105 DF70A, DF80A, DF90A
- 106 **A** DF90, DF100, DF115 **B** DF140
- 108 DF100A, DF115A, DF140A
- 110 DF150, DF175, DF200, DF225, DF250
- 112 DF200, DF225, DF250
- 113 DF250AP, DF350AP
- 114 DF300B, DF325A, DF350A (2018-23)

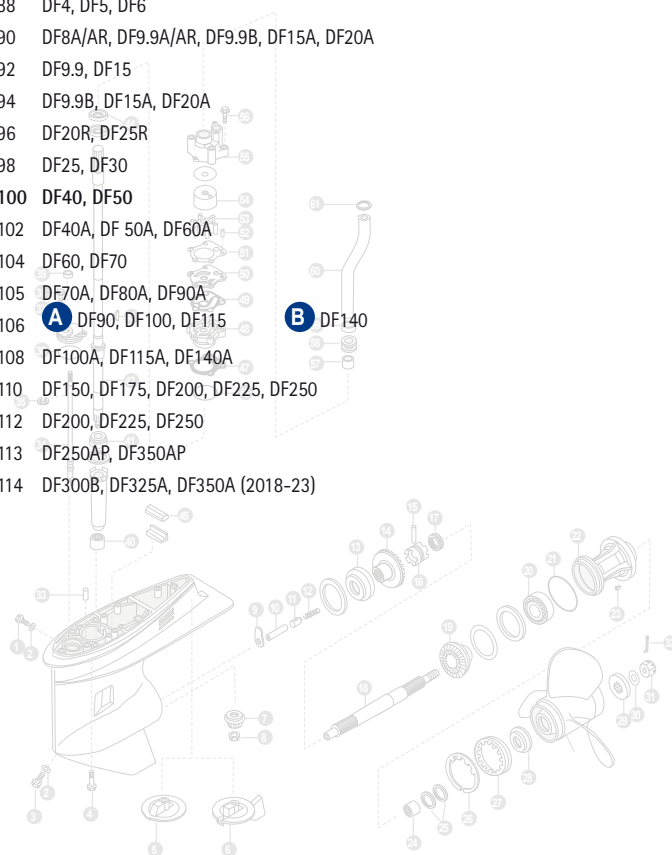



1	MAINTENANCE GUIDE & KITS	4
2	PAINTS	9
<b>FUEL &amp; FILTRATION SYSTEM</b>		
1	FUEL PUMP	10
2	FUEL TANK CONNECTORS	10
3	FUEL FILTERS AND ELEMENTS	11
4	FUEL PUMP	12
5	INJEKTOR	15
6	CARBURATOR	16
7	OIL	17
<b>ELECTRIC SYSTEM</b>		
1	SENSORS	19
2	COILS	21
3	SPARK	22
4	STARTER	23
5	CDI & POWER PACK	25
6	ECM RELAY	25
7	REGULATOR AND RECTIFIERS	25
<b>TRIM SYSTEM</b>		
1	TRIM, TILT & POWER TRIM	27
2	TRIM PARTS	29
3	SWITCHES & SONDES	30
<b>STEERING SYSTEM</b>		
1	ENGINE CONTROLS	32
2	COMPONENTS	34
3	STEERING	34
4	IGNITION STARTER SWITCH	35
5	CUT OFF SWITCHES	35
6	HARNESS	36
7	SILENBLOCK	36
8	BRACKET	37
<b>COOLING SYSTEM</b>		
1	THERMOSTAT	38
2	IMPELLER	39
3	WATER PUMP	42
<b>ANODES</b>		
1	RECMAR ANODE	46
2	ANODES CANADA METAL	50
3	GASKETS & SCREWS	52
<b>ENGINE PARTS</b>		
1	4 STROKES	54
2	ENGINE GASKET, 4 STROKES	69
3	CAMSHAFT	74
4	CRANKSHAFT	75
5	VALVES	76
6	FLY WHEEL	76
7	PISTONS	77
8	GUIDE, TIMING BELT	77
9	2 STROKES	78
10	ENGINE GASKET, 2 STROKES	79
11	CRANKSHAFT	80
12	PISTON	81
13	OIL SEAL	82
<b>EXHAUST SYSTEM</b>		
1	GASKETS 4 STROKES	84
2	GASKETS 2 STROKES	85
<b>INTAKE SYSTEM</b>		
1	GASKETS 4 STROKES	86
2	GASKETS 2 STROKES	86
<b>UNIT DRIVES &amp; COMPONENTS</b>		
1	COMPLETE GEARCASE, 4 STROKES	87
2	4 STROKES	88
3	TOOL	116
4	DRIVE COMPONENTS	116
5	DIABOLO	118
6	CLUTCH DOGS	119
7	BEARING	121
8	GEARS	122
<b>PROPULSION SYSTEM</b>		
1	PROPELLER COMPONENTS	125
2	ALUMINIUM & SS PROPELLERS	127



1	GUÍA KITS MANTENIMIENTO	4
2	PINTURAS	9
<b>SISTEMA DE ALIMENTACIÓN Y FILTRACIÓN</b>		
1	BOMBA DE COMBUSTIBLE	10
2	CONECTORES TANQUE	10
3	FILTROS DE COMBUSTIBLE Y ELEMENTOS	11
4	BOMBA DE COMBUSTIBLE	12
5	INYECTOR	15
6	CARBURADOR	16
7	ACEITE	17
<b>SISTEMA ELÉCTRICO</b>		
1	SENSORES	19
2	BOBINAS	21
3	BUJÍAS	22
4	ARRANQUE	23
5	CDI Y CAJAS NEGRAS	25
6	RELÉ ECM	25
7	REGULADORES Y RECTIFICADORES	25
<b>SISTEMA DE TRIM</b>		
1	TRIM, TILT & POWER TRIM	27
2	DESPIECES TRIM	29
3	INTERRUPTORES Y SENSORES	30
<b>SISTEMA DE GOBIERNO</b>		
1	MANDOS DE CONTROL	32
2	COMPONENTES	34
3	DIRECCIÓN	34
4	LLAVES DE ARRANQUE	35
5	DESCONECTORES DE SEGURIDAD	35
6	ARNÉS	36
7	SILENBLOCK	36
8	BRACKET	37
<b>SISTEMA DE REFRIGERACIÓN</b>		
1	TERMOSTATO	38
2	IMPULSORES	39
3	BOMBA DE AGUA	42
<b>ÁNODOS</b>		
1	ÁNODO RECMAR	46
2	ÁNODOS CANADA METAL	50
3	JUNTAS Y TORNILLOS	52
<b>PARTES DEL MOTOR</b>		
1	4 TIEMPOS	54
2	JUNTAS DE MOTOR, 4 TIEMPOS	69
3	ÁRBOL DE LEVAS	74
4	CIGÜEÑAL	75
5	VÁLVULAS	76
6	VOLANTE	76
7	PISTONES	77
8	GUÍA CORREAS DE DISTRIBUCIÓN	77
9	2 TIEMPOS	78
10	JUNTAS DE MOTOR, 2 TIEMPOS	79
11	CIGÜEÑAL	80
12	PISTONES	81
13	RETÉN DE ACEITE	82
<b>SISTEMA DE ESCAPE</b>		
1	JUNTAS 4 TIEMPOS	84
2	JUNTAS 2 TIEMPOS	85
<b>SISTEMA DE ADMISIÓN</b>		
1	JUNTAS 4 TIEMPOS	86
2	JUNTAS 2 TIEMPOS	86
<b>UNIDADES DE TRANSMISIÓN</b>		
1	COLA COMPLETA, 4 TIEMPOS	87
2	4 TIEMPOS	88
3	HERRAMIENTA	116
4	COMPONENTES DE COLA	116
5	DIÁBOLO	118
6	SELECTOR	119
7	RODAMIENTOS	121
8	PIÑONES	122
<b>SISTEMA DE PROPULSIÓN</b>		
1	COMPONENTES HÉLICE	125
2	HÉLICES ALUMINIO E INOXIDABLE	127



1	GUIDA DE KIT MANUTENZIONE	4
2	PITTURE	9
<b>SISTEMA DI ALIMENTAZIONE E FILTRAZIONE</b>		
1	POMPA BENZINA	10
2	CONETTORI SERBATOIO	10
3	FILTRI BENZINA E RACCORDI	11
4	POMPA BENZINA	12
5	INIETTORE	15
6	CARBURATORE	16
7	OLIO	17
<b>SISTEMA ELETTRICO</b>		
1	SENSORE	19
2	BOBINE	21
3	CANDELE	22
4	AVVIAMENTO	23
5	CDI E CENTRALINA	25
6	RELE ECM	25
7	REGOLATORI E RADDRIZATORI	25
<b>SISTEMA DI TRIM</b>		
1	TRIM, TILT & POWER TRIM	27
2	ESPLOSO TRIM	29
3	INTERRUTTORI E SENSORI	30
<b>SISTEMA DI GUIDA</b>		
1	COMANDI DI CONTROLLO	32
2	COMPONENTI	34
3	COMANDO	34
4	CHIAVI DI ACCENSIONE	35
5	CHIAVETTA DI SICUREZZA	35
6	CAVI	36
7	SILENBLOCK	36
8	BRACKET	37
<b>SISTEMA DI RAFFREDDAMENTO</b>		
1	TERMOSTATO	38
2	GIRANTE	39
3	POMPA ACQUA	42
<b>ANODI</b>		
1	ANODI RECMAR	46
2	ANODI CANADA METAL	50
3	GUARNIZIONI E VITI	52
<b>PARTI MOTORE</b>		
1	4 TEMPI	54
2	GUARNIZIONI DE MOTORE 4 TEMPI	69
3	ALBERO A CAMME	74
4	ALBERO MOTORE	75
5	VALVOLE	76
6	VOLANTE	76
7	PISTONI	77
8	GUIDA CINGHIE DISTRIBUZIONE	77
9	2 TEMPI	78
10	GUARNIZIONI DE MOTORE 2 TEMPI	79
11	ALBERO MOTORE	80
12	PISTONE	81
13	PARAOILIO	82
<b>SISTEMA DI SCARICO</b>		
1	GUARNIZIONI 4 TEMPI	84
2	GUARNIZIONI 2 TEMPI	85
<b>SISTEMA DI ASPIRAZIONE</b>		
1	GUARNIZIONI 4 TEMPI	86
2	GUARNIZIONI 2 TEMPI	86
<b>UNITÀ DI TRASMISSIONE</b>		
1	PIEDI COMPLETI, 4 TEMPI	87
2	4 TEMPI	88
3	ATREZZI	116
4	COMPONENTI PIEDI	116
5	DIABOLO	118
6	SELETTORE	119
7	CUSCINETTO	121
8	PIGNONE	122
<b>SISTEMA DI PROPULSIONE</b>		
1	COMPONENTI DELL'ELICA	125
2	ELICHE ALLUMINIO E INOX	127







1	GUIDE DES KITS DE MAINTENANCE	4
2	PEINTURES	9
<b>SYSTÈME D'ALIMENTATION ET DE FILTRATION</b>		
1	POIRE À CARBURANT	10
2	CONNECTEURS DU RÉSERVOIR	10
3	FILTRE A ESSENCE ET CARTOUCHE DE RECHANGE	11
4	POMPE À ESSENCE	12
5	INJECTEUR	15
6	CARBURATEUR	16
7	HUILE	17
<b>SYSTÈME ÉLECTRIQUE</b>		
1	CAPTEURS	19
2	BOBINES	21
3	BOUGIES	22
4	DEMARRAGE	23
5	CDI ET BOITIER ELECTRONIQUE	25
6	RELAIS ECM	25
7	REGULATEURS ET RECTIFIEURS	25
<b>SYSTÈME DE TRIM</b>		
1	TRIM, TILT & POWER TRIM	27
2	PIÈCES TRIM	29
3	INTERRUPTEURS ET CAPTEURS	30
<b>SYSTÈME DE DIRECTION</b>		
1	BOITIER DE COMMANDE	32
2	COMPOSANT	34
3	COMMANDE	34
4	CONTACTEUR A CLÉ	35
5	COUPE CIRCUIT DE SECURITE	35
6	FAISCEAU ELECTRIQUE	36
7	SILENBLOCK	36
8	BRACKET	37
<b>SYSTÈME DE REFROIDISSEMENT</b>		
1	THERMOSTAT	38
2	TURBINE	39
3	POMPE À EAU	42
<b>ANODES</b>		
1	ANODE RECMAR	46
2	ANODES CANADA METAL	50
3	JOINTS ET VIS	52
<b>PIÈCES MOTEUR</b>		
1	4 TEMPS	54
2	JOINTS DE MOTEUR, 4 TEMPS	69
3	ARBRE A CAMES	74
4	VILEBREQUIN	75
5	SOUPAPES	76
6	VOLANT	76
7	PISTONS	77
8	GUIDE DES COURROIES DE DISTRIBUTION	77
9	2 TEMPS	78
10	JOINTS DE MOTEUR, 2 TEMPS	79
11	VILEBREQUIN	80
12	PISTONS	81
13	JOINT SPI	82
<b>SYSTÈME D'ÉCHAPPEMENT</b>		
1	JOINTS 4 TEMPS	84
2	JOINTS 2 TEMPS	85
<b>SYSTÈME D'ADMISSION</b>		
1	JOINTS 4 TEMPS	86
2	JOINTS 2 TEMPS	86
<b>EMBASES ET PIÈCES</b>		
1	EMBASE COMPLETE, 4 TEMPS	87
2	4 TEMPS	88
3	OUTIL	116
4	PIÈCES D'EMBASES	116
5	DIABOLO	118
6	CRABOT	119
7	ROULEMENT	121
8	PIGNONES	122
<b>SYSTÈME DE PROPULSION</b>		
1	COMPOSANTS DE L'HELICE	125
2	HELICE ALUMINIUM ET INOX	127

## MAINTENANCE GUIDE & KITS

## GUÍA KITS MANTENIMIENTO



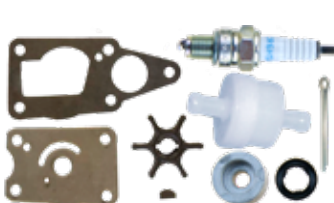

## GUIDA DE KIT MANUTENZIONE

## GUIDE DES KITS DE MAINTENANCE

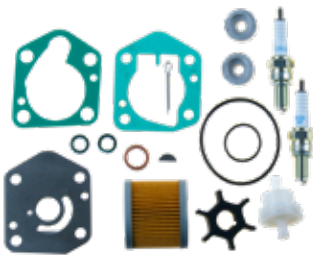
	KIT	CONT.					UN.	
 DF2 DF2.5 (2006-11)	<b>REC17400-97820</b> 	NGKCR6HSA	SPARK PLUG	BUJÍA	CANDELE	BOUGIE	1	
		REC55321-87J01AL	ANODE	ÁNODO	ANODO	ANODE	ANODE	1
		REC09168-10022	CAP, O-RING	ARANDELA TAPÓN	RONDELLA TAPPO	JOINT DE VIDANGE	JOINT DE VIDANGE	1
		PAJASOF404-19-033	O-RING	TÓRICA	O-RING	JOINT TORIQUE	JOINT TORIQUE	1
		REC59178-97J00	DRAIN GASKET	JUNTA DESAGÜE	GUARNIZIONE DRENAGGIO	JOINT DE VIDANGE	JOINT DE VIDANGE	2
		PAGB/T91-1.6X12	COTTER PIN	PIN BLOQUEADOR	COPPIGLIA	GOUPILLE	GOUPILLE	1
		PAGB/T879.1-2.5X14	PIN	PIN	PIN	PIN	PIN	1
		REC17471-97J00	PLATE , WATER PUMP	PLACA BOMBA AGUA	PIASTRA POMPA ACQUA	PLAQUE POMPE A EAU	PLAQUE POMPE A EAU	1
		REC17472-97J00	GASKET, CASE	JUNTA BASE DE BOMBA	GUARNIZIONE, BASE POMPA	JOINT, BASE POMPE	JOINT, BASE POMPE	1
REC17461-97JM0	IMPELLER	TURBINA	GIRANTE	TURBINE	TURBINE	1		
DF2 DF2.5 (2012+)	<b>REC17400-97810</b> 	NGKCR6HSA	SPARK PLUG	BUJÍA	CANDELE	BOUGIE	1	
		REC55321-87J01AL	ANODE	ANODO	ANODO	ANODE	ANODE	1
		PAJASOF404-19-033	O-RING	TÓRICA	O-RING	JOINT TORIQUE	JOINT TORIQUE	1
		REC09168-10022	CAP, O-RING	ARANDELA TAPÓN	RONDELLA TAPPO	JOINT DE VIDANGE	JOINT DE VIDANGE	1
		REC59178-97J00	DRAIN GASKET	JUNTA DESAGÜE	GUARNIZIONE DRENAGGIO	JOINT DE VIDANGE	JOINT DE VIDANGE	2
		REC91490-30025	COTTER PIN	PIN BLOQUEADOR	COPPIGLIA	GOUPILLE	GOUPILLE	1
		PAGB/T879.1-2.5X14	PIN	PIN	PIN	PIN	PIN	1
		REC17471-97JL0	PLATE , WATER PUMP	PLACA BOMBA AGUA	PIASTRA POMPA ACQUA	PLAQUE POMPE A EAU	PLAQUE POMPE A EAU	1
		REC17472-97JL0	GASKET, CASE	JUNTA BASE DE BOMBA	GUARNIZIONE, BASE POMPA	JOINT, BASE POMPE	JOINT, BASE POMPE	1
REC17461-97JM0	IMPELLER	TURBINA	GIRANTE	TURBINE	TURBINE	1		
DF4 DF5 DF6 (2002-10)	<b>REC17400-91860</b> 	NGKBPR6ES	SPARK PLUG	BUJÍA	CANDELE	BOUGIE	1	
		REC55321-87J01AL	ANODE	ANODO	ANODO	ANODE	ANODE	2
		REC09168-10022	CAP, O-RING	ARANDELA TAPÓN	RONDELLA TAPPO	JOINT DE VIDANGE	JOINT DE VIDANGE	3
		REC15410-98500	FUEL FILTER	FILTRO COMBUSTIBLE	FILTRO COMBUSTIBILE	FILTRE ESSENCE	FILTRE ESSENCE	1
		REC91490-30025	COTTER PIN	PIN BLOQUEADOR	SPINOTTO	PIN	PIN	1
REC17400-98661	WATER PUMP REPAIR KIT	KIT BOMBA DE AGUA	KIT POMPA DELL'ACQUA	KIT POMPE À EAU	KIT POMPE À EAU	1		
DF4A/DF5A/DF6A (2017+)	<b>REC17400-91891</b> 	NGKCPR6EA-9	SPARK PLUG	BUJÍA	CANDELE	BOUGIE	1	
		REC55321-87J01AL	ANODE	ANODO	ANODO	ANODE	ANODE	1
		REC68T-11325-00AL	ANODE	ANODO	ANODO	ANODE	ANODE	1
		REC09168-12017	GASKET	JUNTA	GUARNIZIONE	JOINT	JOINT	1
		REC16510-16H11	OIL FILTER	FILTRO DE ACEITE	FILTRO OLIO	FILTRE À HUILE	FILTRE À HUILE	1
		REC68T-24251-00	FUEL FILETR	FILTRO COMBUSTIBLE	FILTRO COMBUSTIBILE	FILTRE ESSENCE	FILTRE ESSENCE	1
		REC91490-30025	COTTER PIN	PIN BLOQUEADOR	COPPIGLIA	GOUPILLE	GOUPILLE	1
		REC17400-98661	WATER PUMP REPAIR KIT	KIT BOMBA DE AGUA	KIT POMPA DELL'ACQUA	KIT POMPE À EAU	KIT POMPE À EAU	1



	KIT	CONT.					UN.
DF4 DF5 DF6 (2011+)	REC17400-91830	NGKCP6EA-9	SPARK PLUG	BUJÍA	CANDELE	BOUGIE	1
		REC55321-87J01AL	ANODE	ANODO	ANODO	ANODE	2
		REC09168-10022	CAP, O-RING	ARANDELA TAPÓN	RONDELLA TAPPO	JOINT DE VIDANGE	3
		REC15410-98500	FUEL FILTER	FILTRO COMBUSTIBLE	FILTRO COMBUSTIBILE	FILTRE ESSENCE	1
		REC91490-30025	COTTER PIN	PIN BLOQUEADOR	COPPIGLIA	GOUPILLE	1
		REC17400-98661	WATER PUMP REPAIR KIT	KIT BOMBA DE AGUA	KIT POMPA DELL'ACQUA	KIT POMPE À EAU	1
DF8A DF9.9A (2010+)	REC17400-99840	NGKCR6E	SPARK PLUG	BUJÍA	CANDELE	BOUGIE	2
		REC55321-87J01AL	ANODE	ANODO	ANODO	ANODO	2
		REC09168-12017	GASKET	JUNTA	GUARNIZIONE	JOINT	1
		REC09280-22019	O-RING	TÓRICA	O-RING	JOINT TORIQUE	1
		REC09280-54001	O-RING	TÓRICA	O-RING	JOINT TORIQUE	1
		REC59178-97J00	DRAIN GASKET	JUNTA DESAGÜE	GUARNIZIONE DRENAGGIO	JOINT DE VIDANGE	2
		REC15410-98500	FUEL FILTER	FILTRO COMBUSTIBLE	FILTRO COMBUSTIBILE	FILTRE ESSENCE	1
		REC16510-05240	OIL FILTER	FILTRO DE ACEITE	FILTRO OLIO	FILTRE D'HUILE	1
		REC09204-02004	COTTER PIN	PIN BLOQUEADOR	COPPIGLIA	GOUPILLE	1
		REC17400-99J01	WATER PUMP REPAIR KIT	KIT BOMBA DE AGUA	KIT POMPA DELL'ACQUA	KIT POMPE À EAU	1
DF9.9 DF15 (2011-13)	REC17400-94810	NGKCP6EA-9	SPARK PLUG	BUJÍA	CANDELE	BOUGIE	2
		CM5033167	ANODE	ANODO	ANODO	ANODO	2
		REC09168-12017	GASKET	JUNTA	GUARNIZIONE	JOINT	1
		REC09168-10022	CAP, O-RING	ARANDELA TAPÓN	RONDELLA TAPPO	JOINT DE VIDANGE	2
		REC15410-98500	FUEL FILTER	FILTRO COMBUSTIBLE	FILTRO COMBUSTIBILE	FILTRE ESSENCE	1
		REC16510-05240	OIL FILTER	FILTRO DE ACEITE	FILTRO OLIO	FILTRE D'HUILE	1
		REC09204-02004	COTTER PIN	PIN BLOQUEADOR	COPPIGLIA	GOUPILLE	1
		REC17400-94J00	WATER PUMP REPAIR KIT	KIT BOMBA DE AGUA	KIT POMPA DELL'ACQUA	KIT POMPE À EAU	1
DF9.9B DF15A DF20A (2013+)	REC17400-89810	NGKCP6EA-9	SPARK PLUG	BUJÍA	CANDELE	BOUGIE	2
		REC55321-87J01AL	ANODE	ANODO	ANODO	ANODO	2
		REC09168-12017	GASKET	JUNTA	GUARNIZIONE	JOINT	1
		REC09280-54001	O-RING	TÓRICA	O-RING	JOINT TORIQUE	1
		REC09280-22019	O-RING	TÓRICA	O-RING	JOINT TORIQUE	1
		REC59178-97J00	DRAIN GASKET	JUNTA DESAGÜE	GUARNIZIONE DRENAGGIO	JOINT DE VIDANGE	2
		REC15410-87L00	FUEL FILTER	FILTRO COMBUSTIBLE	FILTRO COMBUSTIBILE	FILTRE ESSENCE	1
		REC16510-05240	OIL FILTER	FILTRO DE ACEITE	FILTRO OLIO	FILTRE D'HUILE	2
		REC09204-02004	COTTER PIN	PIN BLOQUEADOR	COPPIGLIA	GOUPILLE	1
		REC17400-99J01	WATER PUMP REPAIR KIT	KIT BOMBA DE AGUA	KIT POMPA DELL'ACQUA	KIT POMPE À EAU	1



	KIT	CONT.					UN.			
DF20 DF25 V2 (2006+)		REC17400-95870	NGKBKR6E	SPARK PLUG	BUJÍA	CANDELE	BOUGIE	2		
		REC55321-87J01AL	ANODE	ANODO	ANODO	ANODO	ANODE	5		
		REC09168-10022	CAP, O-RING	ARANDELA TAPÓN	RONDELLA TAPPO	JOINT DE VIDANGE		2		
		REC09168-12012	GASKET	JUNTA	GUARNIZIONE	JOINT		1		
		REC09280-22019	O-RING	TÓRICA	O-RING	JOINT TORIQUE		1		
		REC16510-87J00	OIL FILTER	FILTRO DE ACEITE	FILTRO OLIO	FILTRE D'HUILE		1		
		REC15410-87J30	FUEL FILTER	FILTRO COMBUSTIBILE	FILTRO COMBUSTIBILE	FILTRE ESSENCE		1		
		REC17413-95J00	INSERT CARTRIDGE	ACOPLE INOX	ACCOPPIAMENTO INOX	INSERT INOX		1		
		REC91490-30025	COTTER PIN	PIN BLOQUEADOR	COPPIGLIA	GOUPILLE		1		
		REC17400-95J02	WATER PUMP REPAIR KIT	KIT BOMBA DE AGUA	KIT POMPA DELL'ACQUA	KIT POMPE À EAU		1		
DF25 DF30 (2001-10)		REC17400-89820	NGKDCPR6E	SPARK PLUG	BUJÍA	CANDELE	BOUGIE	3		
		REC55321-87J01AL	ANODE	ANODO	ANODO	ANODO	ANODO	1		
		REC09168-10022	CAP, O-RING	ARANDELA TAPÓN	RONDELLA TAPPO	JOINT DE VIDANGE		2		
		REC09168-12012	GASKET	JUNTA	GUARNIZIONE	JOINT		1		
		REC16510-87J00	OIL FILTER	FILTRO DE ACEITE	FILTRO OLIO	FILTRE D'HUILE		1		
		REC15410-87J10	FUEL FILTER	FILTRO COMBUSTIBILE	FILTRO COMBUSTIBILE	FILTRE		1		
		REC91490-30025	COTTER PIN	PIN BLOQUEADOR	COPPIGLIA	GOUPILLE		1		
		REC17400-96403	WATER PUMP REPAIR KIT	KIT BOMBA DE AGUA	KIT POMPA DELL'ACQUA	KIT POMPE À EAU		1		
		DF25A DF30A (2015+)		REC17400-94821	NGKDCPR6EA-9	SPARK PLUG	BUJÍA	CANDELE	BOUGIE	3
				REC55321-87J01AL	ANODE	ANODO	ANODO	ANODO	ANODE	5
REC09168-12017	GASKET			JUNTA	GUARNIZIONE	JOINT		1		
REC09280-22019	O-RING			TÓRICA	O-RING	JOINT TORIQUE		1		
REC16510-87J00	OIL FILTER			FILTRO DE ACEITE	FILTRO OLIO	FILTRE D'HUILE		1		
REC15410-87L00	FUEL FILTER			FILTRO COMBUSTIBILE	FILTRO COMBUSTIBILE	FILTRE ESSENCE		1		
REC59178-97J00	DRAIN GASKET			JUNTA DESAGÜE	GUARNIZIONE DRENAGGIO	JOINT DE VIDANGE		2		
REC91490-30025	COTTER PIN			PIN BLOQUEADOR	COPPIGLIA	GOUPILLE		1		
REC17400-94L00	WATER PUMP REPAIR KIT			KIT BOMBA DE AGUA	KIT POMPA DELL'ACQUA	KIT POMPE À EAU		1		
DF40 DF50 (2006-10)				REC17400-87820	NGKDCPR6E	SPARK PLUG	BUJÍA	CANDELE	BOUGIE	3
		REC55321-87J01AL	ANODE	ANODO	ANODO	ANODO	ANODO	2		
		REC09168-10022	CAP, O-RING	ARANDELA TAPÓN	RONDELLA TAPPO	JOINT DE VIDANGE		2		
		REC09168-12012	GASKET	JUNTA	GUARNIZIONE	JOINT		1		
		REC09280-22019	O-RING	TÓRICA	O-RING	JOINT TORIQUE		2		
		REC16510-87J00	OIL FILTER	FILTRO DE ACEITE	FILTRO OLIO	FILTRE D'HUILE		1		
		REC15410-87J30	FUEL FILTER	FILTRO COMBUSTIBILE	FILTRO COMBUSTIBILE	FILTRE ESSENCE		1		
		REC91490-30025	COTTER PIN	PIN BLOQUEADOR	COPPIGLIA	GOUPILLE		1		
		REC17400-96403	WATER PUMP REPAIR KIT	KIT BOMBA DE AGUA	KIT POMPA DELL'ACQUA	KIT POMPE À EAU		1		
		DF40A DF50A DF60A (2010+)		REC17400-88810	NGKDCPR6E	SPARK PLUG	BUJÍA	CANDELE	BOUGIE	3
REC55321-87J01AL	ANODE			ANODO	ANODO	ANODO	ANODO	3		
REC09168-12012	GASKET			JUNTA	GUARNIZIONE	JOINT		1		
REC09168-10022	CAP, O-RING			ARANDELA TAPÓN	RONDELLA TAPPO	JOINT DE VIDANGE		2		
REC09280-22019	O-RING			TÓRICA	O-RING	JOINT TORIQUE		2		
REC16510-87J00	OIL FILTER			FILTRO DE ACEITE	FILTRO OLIO	FILTRE À HUILE		1		
REC15410-88L00	FUEL FILTER			FILTRO COMBUSTIBILE	FILTRO COMBUSTIBILE	FILTRE ESSENCE		1		
REC91490-30025	COTTER PIN			PIN BLOQUEADOR	COPPIGLIA	GOUPILLE		1		
REC17400-88L00	WATER PUMP REPAIR KIT			KIT BOMBA DE AGUA	KIT POMPA DELL'ACQUA	KIT POMPE À EAU		1		

	KIT	CONT.					UN.	
DF60 DF70 (1997-07)	REC17400-99870	NGKBPR6ES	SPARK PLUG	BUJÍA	CANDELE	BOUGIE	4	
		REC55321-87J01AL	ANODE	ANODO	ANODO	ANODO	1	
		REC09168-10022	CAP, O-RING	ARANDELA TAPÓN	RONDELLA TAPPO	JOINT DE VIDANGE	2	
		REC09168-12012	GASKET	JUNTA	GUARNIZIONE	JOINT	1	
		REC16510-87J00	OIL FILTER	FILTRO DE ACEITE	FILTRO OLIO	FILTRE À HUILE	1	
		REC15410-87J30	FUEL FILTER	FILTRO COMBUSTIBLE	FILTRO COMBUSTIBILE	FILTRE ESSENCE	1	
		REC91490-30025	COTTER PIN	PIN BLOQUEADOR	COPPIGLIA	GOUPILLE	1	
	REC17400-87E04	WATER PUMP REPAIR KIT	KIT BOMBA DE AGUA	KIT POMPA DELL'ACQUA	KIT POMPE À EAU	1		
DF70A DF80A DF90A (2009+)	REC17400-87810	NGKDCPR6E	SPARK PLUG	BUJÍA	CANDELE	BOUGIE	4	
		REC55321-87J01AL	ANODE	ANODO	ANODO	ANODE	3	
		REC09168-12012	GASKET	JUNTA	GUARNIZIONE	JOINT	1	
		REC09168-10034	GASKET	JUNTA	GUARNIZIONE	JOINT	2	
		REC09280-22019	O-RING	TÓRICA	O-RING	JOINT TORIQUE	3	
		REC16510-90J00	OIL FILTER	FILTRO ACEITE	FILTRO OLIO	FILTRO À HUILE	1	
		REC15410-87L00	FUEL FILTER	FILTRO COMBUSTIBLE	FILTRO COMBUSTIBILE	FILTRE ESSENCE	1	
		REC91490-30025	COTTER PIN	PIN BLOQUEADOR	COPPIGLIA	GOUPILLE	1	
			REC17400-87L01	WATER PUMP REPAIR KIT	KIT BOMBA DE AGUA	KIT POMPA DELL'ACQUA	KIT POMPE À EAU	1
DF100 DF115 (2010-12)	REC17400-92840	NGKBKR6E	SPARK PLUG	BUJÍA	CANDELE	BOUGIE	4	
		REC55321-87J01AL	ANODE	ANODO	ANODO	ANODE	4	
		REC09168-10022	CAP, O-RING	ARANDELA TAPÓN	RONDELLA TAPPO	JOINT DE VIDANGE	2	
		REC09168-12012	GASKET	JUNTA	GUARNIZIONE	JOINT	1	
		REC09280-22019	O-RING	TÓRICA	O-RING	JOINT TORIQUE	2	
		REC16510-90J00	OIL FILTER	FILTRO ACEITE	FILTRO OLIO	FILTRE À HUILE	1	
		REC15410-87J30	FUEL FILTER	FILTRO COMBUSTIBLE	FILTRO COMBUSTIBILE	FILTRE ESSENCE	1	
		REC91490-30025	COTTER PIN	PIN BLOQUEADOR	COPPIGLIA	GOUPILLE	1	
		REC09420-05009	KEY	CHAVETA	CHIAVETTA	CLAVETTE	1	
			REC17400-92J21	WATER PUMP REPAIR KIT	KIT BOMBA DE AGUA	KIT POMPA DELL'ACQUA	KIT POMPE À EAU	1
DF100A DF115A DF140A (2013+)	REC17400-92821	NGKBKR6E	SPARK PLUG	BUJÍA	CANDELE	BOUGIE	4	
		REC55321-87J01AL	ANODE	ANODO	ANODO	ANODE	4	
		REC09168-12012	GASKET	JUNTA	GUARNIZIONE	JOINT	1	
		REC09168-10022	CAP, O-RING	ARANDELA TAPÓN	RONDELLA TAPPO	JOINT DE VIDANGE	2	
		REC09280-22019	O-RING	TÓRICA	O-RING	JOINT TORIQUE	2	
		REC16510-90J00	OIL FILTER	FILTRO ACEITE	FILTRO OLIO	FILTRE À HUILE	1	
		REC15412-92J00	FUEL FILTER	FILTRO COMBUSTIBLE	FILTRO COMBUSTIBILE	FILTRE ESSENCE	1	
		REC91490-30025	COTTER PIN	PIN BLOQUEADOR	COPPIGLIA	GOUPILLE	1	
		REC09420-05009	KEY	CHAVETA	CHIAVETTA	CLAVETTE	1	
			REC17400-92J21	WATER PUMP REPAIR KIT	KIT BOMBA DE AGUA	KIT POMPA DELL'ACQUA	KIT POMPE À EAU	1

	KIT	CONT.				UN.	
DF140 (2010-12)	REC17400-92850	NGKBKR6E	SPARK PLUG	BUJÍA	CANDELE	BOUGIE	4
		REC55321-87J01AL	ANODE	ANODO	ANODO	ANODE	4
		REC09280-22019	O-RING	TÓRICA	O-RING	JOINT TORIQUE	2
		REC09168-10022	CAP, O-RING	ARANDELA TAPÓN	RONDELLA TAPPO	JOINT DE VIDANGE	2
		REC09168-12012	GASKET	JUNTA	GUARNIZIONE	JOINT	1
		REC16510-90J00	OIL FILTER	FILTRO ACEITE	FILTRO OLIO	FILTRE À HUILE	1
		REC15410-87J30	FUEL FILTER	FILTRO COMBUSTIBLE	FILTRO COMBUSTIBILE	FILTRE ESSENCE	1
		REC91490-30025	COTTER PIN	PIN BLOQUEADOR	COPPIGLIA	GOUPILLE	1
		REC09420-05009	KEY	CHAVETA	CHIAVETTA	CLAVETTE	1
			REC17400-92J21	WATER PUMP REPAIR KIT	KIT BOMBA DE AGUA	KIT POMPA DELL'ACQUA	KIT POMPE À EAU
DF150 DF175 (2006+)	REC17400-96821	NGKBKR6E	SPARK PLUG	BUJÍA	CANDELE	BOUGIE	4
		REC55321-87J01AL	ANODE	ANODO	ANODO	ANODE	6
		REC09168-10034	GASKET	JUNTA	GUARNIZIONE	JOINT	2
		REC09168-12012	GASKET	JUNTA	GUARNIZIONE	JOINT	1
		REC09280-22019	O-RING	TÓRICA	O-RING	JOINT TORIQUE	5
		REC16510-93J00	OIL FILTER	FILTRO DE ACEITE	FILTRO OLIO	FILTRE À HUILE	1
		REC15410-96J00	FUEL FILTER	FILTRO COMBUSTIBLE	FILTRO COMBUSTIBILE	FILTRE ESSENCE	1
		REC17413-96J01	INSERT CARTRIDGE	ACOPLE INOX	ACCOPPIAMENTO INOX	INSERT INOX	1
		REC91490-30025	COTTER PIN	PIN BLOQUEADOR	SPINOTTO	PIN	1
			REC17400-96J03	WATER PUMP REPAIR KIT	KIT BOMBA DE AGUA	KIT POMPA DELL'ACQUA	KIT POMPE À EAU
DF200 DF225 DF250 (2011+)	REC17400-93851	NGKBKR6E	SPARK PLUG	BUJÍA	CANDELE	BOUGIE	6
		CM55321-94900A	ANODE	ANODO	ANODO	ANODE	1
		REC55321-87J01AL	ANODE	ANODO	ANODO	ANODE	7
		REC09168-10034	GASKET	JUNTA	GUARNIZIONE	JOINT	2
		REC09168-12012	GASKET	JUNTA	GUARNIZIONE	JOINT	1
		REC09280-22019	O-RING	TÓRICA	O-RING	JOINT TORIQUE	7
		REC16510-93J00	OIL FILTER	FILTRO DE ACEITE	FILTRO OLIO	FILTRE À HUILE	1
		REC15412-93J10	FUEL FILTER	FILTRO COMBUSTIBLE	FILTRO COMBUSTIBILE	FILTRE ESSENCE	1
		REC91490-30025	COTTER PIN	PIN BLOQUEADOR	COPPIGLIA	GOUPILLE	1
			REC17400-93J01	WATER PUMP REPAIR KIT	KIT BOMBA DE AGUA	KIT POMPA DELL'ACQUA	KIT POMPE À EAU
DF200A/AP DF150AP DF175AP (2016+)	REC17400-96832	NGKLR6E	SPARK PLUG	BUJÍA	CANDELE	BOUGIE	4
		REC55321-87J01AL	ANODE	ANODO	ANODO	ANODO	6
		REC09168-10034	GASKET	JUNTA	GUARNIZIONE	JOINT	2
		REC09168-12012	GASKET	JUNTA	GUARNIZIONE	JOINT	1
		REC09280-22019	O-RING	TÓRICA	O-RING	JOINT TORIQUE	5
		REC16510-93J00	OIL FILTER	FILTRO DE ACEITE	FILTRO OLIO	FILTRE À HUILE	1
		REC15412-92J00	FUEL FILTER	FILTRO COMBUSTIBLE	FILTRO COMBUSTIBILE	FILTRE ESSENCE	1
		REC17413-96J01	INSERT CARTRIDGE	ACOPLE INOX	ACCOPPIAMENTO INOX	INSERT INOX	1
		REC91490-30025	COTTER PIN	PIN BLOQUEADOR	COPPIGLIA	GOUPILLE	1
			REC17400-96J03	WATER PUMP REPAIR KIT	KIT BOMBA DE AGUA	KIT POMPA DELL'ACQUA	KIT POMPE À EAU

	KIT	CONT.					UN.	
 DF250A DF250S DF300 (A) (2011+)	 <b>REC17400-98861</b>	<b>NGKBKR6E</b>	SPARK PLUG	BUJÍA	CANDELE	BOUGIE	6	
		<b>REC55321-87J01AL</b>	ANODE	ANODO	ANODO	ANODE	8	
		<b>CM55321-94900A</b>	ANODE	ANODO	ANODO	ANODE	1	
		<b>REC09168-10034</b>	GASKET	JUNTA	GUARNIZIONE	JOINT	2	
		<b>REC09168-12012</b>	GASKET	JUNTA	GUARNIZIONE	JOINT	1	
		<b>REC09280-22019</b>	O-RING	TÓRICA	O-RING	JOINT TORIQUE	7	
		<b>REC16510-93J00</b>	OIL FILTER	FILTRO DE ACEITE	FILTRO OLIO	FILTRE À HUILE	1	
		<b>REC15412-93J10</b>	FUEL FILTER	FILTRO COMBUSTIBLE	FILTRO COMBUSTIBILE	FILTRE	1	
		<b>REC91490-30025</b>	COTTER PIN	PIN BLOQUEADOR	COPPIGLIA	GOUPILLE	1	
	<b>REC17400-98J01</b>	WATER PUMP REPAIR KIT	KIT BOMBA DE AGUA	KIT POMPA DELL'ACQUA	KIT POMPE À EAU	1		
DF350A/DF325A (2018+)	<b>REC17400-98875</b>	<b>NGKILZKR7D8</b>	SPARK PLUG	BUJÍA	CANDELE	BOUGIE	6	
		<b>REC55321-87J01AL</b>	ANODE, PROTECTION	ANODO	ANODO	ANODE	7	
		<b>REC55320-94900AL</b>	ANODE SET, CLAMP BRACKET	ANODO	ANODO	ANODE	1	
		<b>REC09168-10034</b>	GASKET	JUNTA	GUARNIZIONE	JOINT	3	
		<b>REC09168-12012</b>	GASKET	JUNTA	GUARNIZIONE	JOINT	1	
		<b>REC09280-22019</b>	O RING	TÓRICA	O-RING	JOINT TORIQUE	7	
		<b>REC16510-93J00</b>	OIL FILTER	FILTRO DE ACEITE	FILTRO OLIO	FILTRE À HUILE	1	
		<b>REC15412-93J10</b>	FUEL FILTER	FILTRO COMBUSTIBLE	FILTRO COMBUSTIBILE	FILTRE ESSENCE	1	
		<b>REC91490-30025</b>	COTTER PIN	PIN BLOQUEADOR	COPPIGLIA	GOUPILLE	1	
		<b>REC17413-93J02</b>	INSERT CARTRIDGE	ACOPLE INOX	ACCOPPIAMENTO INOX	INSERT INOX	1	
			<b>REC17400-98L03</b>	WATER PUMP REPAIR KIT	KIT BOMBA DE AGUA	KIT POMPA DELL'ACQUA	KIT POMPE À EAU	1

2

## PAINTS

## PINTURAS

## PITTURE

## PEINTURES

SPRAY PAINT		PINTURA EN SPRAY		PITTURE SPRAY		PEINTURE EN SPRAY	
REF	OEM	COLOUR	COLOR	COLORE	COLEUR		
GS90019		Clear Varnish	Barniz transparente	Vernice trasparente	Vernis transparent		
GS90032		Silver (1983-89)	Plateado (1983-89)	Argento (1983-89)	Argent (1983-89)		
GS90025	990F0-41005-OED	California Grey Metal (1989+)	Gris metalizado California (1989+)	Grigio metallizzato California (1989+)	Gris métallisé California (1989+)		
GS90042	990F0-41005-OEP	Shadow Black Metal	Negro metalizado Shadow	Nero Metallizzato Shadow	Noir Métallisé Shadow	400 ml	
GS90050	990F0-41005-YAY	Pearl Nebular black	Pearl Nebular negro	Pearl Nebular negro	Pearl Nebular noir		
GS90051	990F0-41005-Y5S	Cool white	Cool blanco	Cool bianco	Cool blanc		
GS90052	990F0-41005-QTN	Super cool white	Super cool blanco	Super cool bianco	Super cool blanc		
GS90015		SS.	Inox.	Inox.	Inox.		
GS90001							
GS90012		SPRAY PRIMER	IMPRIMACIÓN MOTOR	PRIMER PER MOTORI	PRIMER POUR MOTEUR	400 ml	
GS90013							
GS90008		<input checked="" type="checkbox"/>					
GS90009		ANTIFOULING FOR STERN-DRIVES	ANTIFOULING PARA COLAS	ANTIFOULING PER PIEDI	ANTIFOULING POUR EMBASES	400 ml	
GS90010							
GS90011							



# Fuel & Filtration System

## FUEL & FILTRATION SYSTEM

## SISTEMA DE ALIMENTACIÓN Y FILTRACIÓN

## SISTEMA DI ALIMENTAZIONE E FILTRAZIONE

## SYSTÈME D'ALIMENTATION ET DE FILTRATION

1

➕  
OPTIONS  
INSTAL.  
P. 59

### FUEL PUMP

- Premium quality bulb  
- Resistance to alcohol as well as UV.

### BOMBA DE COMBUSTIBLE

- Elastómeros termoplásticos inyectados  
- Resistentes al alcohol y rayos UV

### POMPA BENZINA

- Elastomero termoplastico  
- Resistente ai solventi e raggi UV.

### POIRE À CARBURANT

- Élastomères thermoplastiques injectés  
- Résistant à l'alcool et aux rayons UV.

REF	OEM	
GS31187	65770-95541	1/4" = 6 mm
GS31090	65770-93J12	5/16" = 8 mm
GS31095	65770-90J12	3/8" = 9.5 mm



2

➕  
OPTIONS  
INSTAL.  
P. 60

### FUEL TANK CONNECTORS

### CONECTORES TANQUE

### CONETTORI SERBATOIO



### CONNECTEURS DU RÉSERVOIR

#### TANK CONNECTOR

#### CONECTOR DE DEPÓSITO

#### ATTACCO SERBATOIO

#### RACCORDS DE RESERVOIR

REF	OEM			COMPATIBLE CONNECTOR		Ø INT
1 REC65750-94404	65750-94404/3/2/1	DT4 --> DT140		REC65720-94403 REC65720-94411		
2 REC65750-87J11	65750-87J11		DF4--> DF140 HP	REC65720-986L0		3/8"
3 REC65720-98520	65720-98520/1 65720-98500/1/2 65720-985L1	2 --> 65 HP	9.9, 15 HP			
4 REC65740-99100	65740-99100	2 --> 60 HP		REC65750-98506		1/4" NPT
5 REC65750-98506	65750-98506	2 --> 60 HP				5/16"
REC65750-98505	65750-98506	2 --> 60 HP				3/8"
6 REC65720-94403	65720-94403	DT4--> 65 HP old   antiguos vecchio   ancien		REC65750-94404		1/4" NPT
7 REC65720-94411	65720-94411	DT75- 140 HP old   antiguos vecchio   ancien		REC65750-94404		
8 REC65740-95D01	65740-95D00					1/4" NPT 13 mm
9 REC65720-986L0	65720-986L0 65720-986A0 65720-986B0		DF25 --> DF140	REC65750-87J11		

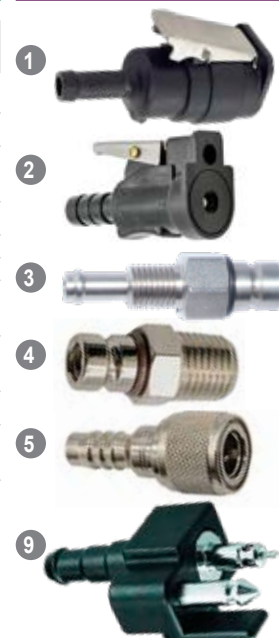

6

7

8





9





FUEL FILTERS AND ELEMENTS

FILTROS DE COMBUSTIBLE Y ELEMENTOS

FILTRI BENZINA E RACCORDI









FILTRE A ESSENCE ET CARTOUCHE DE RECHANGE

IN-LINE FILTER		FILTRO PARA MONTAJE EN LINEA	
REF	OEM		
1 REC15410-98500	15410-98500		DF4/5/6 (2002-14) DF8A, DFAR, DF9.9A/AR (2010+) DF9.9, DF15T-K3 (1996-03) DF9.9, DF15 (R) (2004-12) DF15 (2010-12) DF40, DF50X-K10 (1999-10) DF60, DF70W-K9 (1998-09) DF150T-Z, DF175T-Z (2006-11)
2 REC16910-GB2-005	15410-94350		DT5Y (1998-02) DT9.9, DT15K1-K4 (2001-04) DT9.9K, DT15KG-Y (1986-00) DT40C/W/G7X (1986-99) DT40WK1-K4 (2001-04)
3 REC15410-87L00	15410-87L00		DF9.9B (2013) DF15A, DF20A (2013-23) DF25A, DF30A (2015-23) DF70A (2010-20)
4 REC69J-24501-10	15643-93J00		DF80A, DF90A (2009+) DF200, DF225, DF250 (2004+) DF250AP, DF300AP (2013+) DF300T/Z (2007-11) DF300AP (2012)

FILTRO PER MONTARE IN LINEA		FILTRE POUR MONTAGE EN LIGNE	
REF	OEM		
5 REC15410-87J30	15410-87J30		DF20R, DF25, DF25R V2 (2006-11) DF25V (2010-14) DF40 (2009-11) DF50X-K10 (1999-10) DF60, DF70W-K9 (1998-09) DF90, DF100, DF115 K1-K11 (2001-11) DF140 (2002-12)
6 REC15410-96J00	15410-96J00		DF150T-Z, DF175T-Z (2006-13) DF150T (G)Z, DF175T (G)Z (2014) DF150, DF175 (2010-18) DF25, DF30Y-K6 (2000-06) DF40, DF50X-K10 (1999-10) DF60, DF70W-K9 (1998-09) DF90, DF100, DF115K1-K11 (2001-11)
7 REC15410-87J10	15410-87J10		DF140 (2002-11) DF115 (2010) DF140 (2010-11)
8 REC15410-88L00	15410-88L00		DF40A, DF50A, DF60A (2010-23)











FILTER ASSY	FILTRO COMPLETO	FILTRO COMPLETO	FILTRE COMPLET
-------------	-----------------	-----------------	----------------

REF	OEM		
1 PAF15-07080000	15410-94400		
2 REC15410-93J00	15410-93J00		
3 REC15410-93J11	15410-93J10/11		





ELEMENTS	ELEMENTOS	ELEMENTI	ELEMENTS
----------	-----------	----------	----------

REF	OEM		
A REC90794-46913	65910-98J00		DF8 --> DF300 (2004+) DT9.9 40HP (2015+)
B PAF15-07080002	15413-87D10		DT5, DT6, DT8G-Y, DT9.9K, DT15K-G-Y, DT20, DT25, DT30G-Y (1986-00) DT25C, DT30C-K-Y (1989-00) DT55, DT65J-X (1988-99) DT40C-W-G-X (1986-99)
C REC15412-92J00	15412-92J00		DF70A (2018-23) DF75A (2023) DF80A, DF90A, DF100B (2018+) DF100A, DF115, DF140A (2013+) DF115A (2013-21)
D REC6P3-24564-00	15415-93J10		DF115B, DF140B (2022-23) DF150, DF175, DF200 A/AP/AT (2015+)

REF	OEM		
D REC6P3-WS24A-00	15412-93J10		DF200, DF225, DF250 (2004+) DF250AP, DF300AP (2015+) DF300T/F (2004-11) DF350A, DF325A (2018+)
E REC65L-24563-00	15412-93J00		DF200, DF225, DF250 (2004-11) DF300T-Z (2007-11)
F REC15412-93J10	15412-93J10		DF200 (2010-14) DF225, DF250 (2010-23) DF250AP (2013-23) DF300 (2010-11) DF300AP (2012-23) DF300B (2020-23) DF350A (2018-23)







VST FILTER		FILTROS VST		FILTRO VST	FILTRE VST
REF	OEM				
1 REC63P-13915-00	15642-88L00	DF40A, DF50A DF60A DF70A, DF90A DF75A DF115 DF115A, DF140A	(2011-23) (2010-23) (2014-23) (2023) (2011-12) (2013-23)		
2 REC15642-90J00	15642-90J00	DF90 - DF350		<b>NEW</b>	<b>NEW</b>

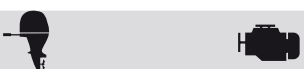

HIGH PRESSURE FUEL FILTER		FILTRO COMBUSTIBLE ALTA PRESIÓN		FILTRO BENZINA ALTA PRESSIONE	FILTRE À ESSENCE HAUTE PRESSION
REF	OEM				
1 REC15410-87J00	15410-87J10	DF40, DF50X-K10	(1999-10)		
2 REC15440-99E01	15440-99E00/01	DF60, DF70W-K9	(1998-09)		
3 REC15440-87L10	15440-87L10	DF70A, DF80A, DF90A	(2009-12)		
4 REC15440-90J00	15440-90J00	DF90, DF100, DF115 DF140	(2002-11) (2002-12)		
5 REC15440-96J01	15440-96J01	DF150, DF175, DF200 A/P DF150, DF175, DF200 G/Z/AT	(2015+) (2006+)		
6 REC15440-96J00	15440-96J00	DF150T/Z, DF175T/Z	(2006-11)		
7 REC15440-93J00	15440-93J00	DF200, DF225, DF250 DF250AP, DF300AP DF300T/Z	(2004-18) (2012+) (2007-11)		



4

FUEL PUMP		BOMBA DE COMBUSTIBLE		POMPA BENZINA	POMPE À ESSENCE
FUEL PUMP MECHANICAL		BOMBA MECÁNICA		POMPA MECCANICA	POMPE MECANIQUE
REF	OEM				
1 PAF4-04090000	15100-91J00/01/02	DF4, DF5, DF6	(2002+)		
2 REC692-24410-00	15100-94301/03/10/11	DT8, D9.9C DT20/25/30 DT25/30 DT25C, DT30C DT40C-W DT40W DT55/65	J-V (1988-99) G-Y (1986-00) K1-K2 (2001-02) K-Y (1989-00) G-X (1986-99) K1-K4 (2001-04) J-X (1988-99)	4	2
3 REC15100-94J03	5100-94J03	DF8A, DF9.9AR/A DF15	(2013+) (2010-12)		
4 REC15100-93912	15100-93910/11/12 15100-90900	DT9.9, DT15 DT9.9K, DT15K DT15C	K1-K4 (2001-04) G-Y (1986-00) (1989-97)	2	
5 REC15100-89L21	15100-89L10/11/21	DF9.9B/15A/20A DF15A DF20A	(2015+) (2013-23) (2013-23)	4	
6 REC15100-95J04	15100-95J03/04	DF25/DF25R/DF25Q DF25V	V2 (2010-14) (2010-14)	4	



REF	OEM		
7 REC15100-94L01	15100-94L00/01	DF25A/30A	(2015-23) 4
8 REC15100-87J03	15100-87J01/02/03 15100-87J0V	DF40/50	X-K10 (2010) 4
9 REC15100-90J11	15100-90J00/01/10/11 15100-90J1V0	DF40A/50A/60A DF70A/80A/90A/100B DF75A DF90A/ DF100B/ DF115 DF115 DF100A/115A/140A DF140 DF140A DF115WT/140WT K3	(2010-23) (2009+) (2023) (2001-11) (2010-12) (2013-21) (2002-12) (2013-20) (2003) 4
10 REC15100-99E11	15100-99E11	DF60, DF70WK-9	(1998-09) 4
11 REC15100-96J01	15100-96J01 15100-96J0V	DF150T/Z, DF175T/Z DF150A/175A/200A DF115BG/BZG, DF100C DF115A DF115B DF140A DF140B DF150 DF150A DF175 DF175A DF200A	(2006-18) (2015+) (2021+) (2021) (2022-23) (2021) (2022-23) (2010-18) (2019-23) (2010-18) (2019-23) (2015-23) 4





**HIGH PRESSURE, FUEL PUMP**

**BOMBA DE COMBUSTIBLE, ALTA PRESIÓN**

**POMPA BENZINA, ALTA PRESSIONE**

**POMPE À ESSENCE, HAUTE PRESSION**

REF	OEM			
1 REC63P-13907-03	15200-90J00/01	DF40, DF50 DF70A, DF90A DF70A, DF80A, DF90A DF115 DF100A, DF115A DF100A, DF115A, DF140A DF140A DF140 DF200, DF225, DF250	(2010) (2010-13) (2014+) (2010) (2013) (2014+) (2013) (2010-12) (2004+)	4 REC63P-14984-00
2 REC15200-92J20	15200-92J00/20	DF40A, DF50A DF60A DF70A/DF90A DF75A DF80A DF115 DF100A, DF115A, DF140A DF115B, DF140B	(2011-23) (2010-23) (2014-23) (2023) (2011-12) (2013-21) (2022-23)	4
3 REC15200-96J00	15200-96J00	DF150, DF175 DF150A, DF175A DF200 DF200A DF225, DF250 DF250AP	(2010-18) (2019-23) (2010-14) (2015-23) (2010-23) (2013-23)	4
4 REC15200-98L00	15200-98L00	DF300 DF300AP DF300B DF350A	(2010-11) (2012-23) (2020-23) (2018-23)	4



**LOW PRESSURE FUEL PUMP**

**BOMBA DE COMBUSTIBLE BAJA PRESIÓN**

**POMPA BENZINA BASSA PRESSIONE**

**POMPE À ESSENCE BAISE PRESSION**

REF	OEM	
1 REC15100-94900	15100-94900	DF200/225/250 DF250AP, DF300AP DF300 DF350A, DF325A DF300T/Z DT115, DT140 DT150/200/225 DF200/225/250
2 REC15100-98J00	15100-98J00	DF250AP, DF300AP, DF350A DF300B DF350A, DF325A



DIAPHRAGMS & GASKETS SETS

KITS MEMBRANAS Y JUNTAS

KIT MEMBRANA E GUARNIZIONI

KIT MEMBRANES ET JOINTS

REF	OEM		
1 REC15170-98110	15170-98110	DT4, J4, DT5Y DT4 K1 DT5Y DT5, DT6, DT8G-Y DT6, DT8Y-K2	(1988-00) (2001) (1998-02) (1986-00) (2000-02)
2 REC15170-91J00	15170-91J00	DF4, DF5, DF6	(2002-11)
3 REC15170-94J00	15170-94J00	DF8A/AR, DF9.9A/AR DF9.9, DF15 (R)	(2010-11) (2004-11)
4 REC15170-93911	15170-93920	DT8, DT9.9C-J-V DT9.9K, DT15K-G-Y DT9.9, DT15K1-K4 DT15C	(1988-97) (1986-00) (2001-04) (1989-97)
5 REC15170-99E00	15170-99E00	DF9.9, DF15R-K3 DF25, DF30Y K6 DF40, DF50Z-K10 DF60, DF70W-K9	(1996-03) (2000-06) (1999-10) (1998-09)
6 REC15170-94320	15170-94320	DT20, DT25, DT30G-Y DT25/30 K1-K2 DT25C, DT30CK-Y DT40C/W/G/X DT40W-K1-K4 DT55, DT65J-X	(1986-00) (2001-02) (1989-00) (1986-99) (2001-04) (1988-99)
7 REC15100-7281V	15100-7281V 15100-72811/12	DT115/DT140 G-Y DT150/DT200/DT225 W-K3 DT75/DT85J-Y DT90/DT100 L-Y V6 H-Y	(1986-00) (1998-03) (1988-00) (1990-00) (1987-00)

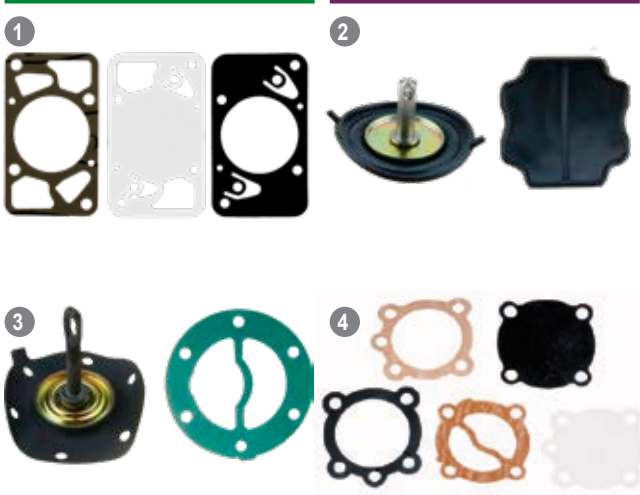

VST GASKETS

JUNTAS VST

GUARNIZIONE VST

JOINTS VST

REF	OEM		
1 REC15626-99E00	15626-99E00 15643-99E00	DF40, DF50 DF60, DF70 W-K9	(1999-10) (1998-09)
2 REC15626-88L01	15626-88L00/01	DF40A, DF50A DF60A	(2011-23) (2010-23)
3 REC15626-90J00	15626-90J00	DF70A, DF80A, DF90A DF90, DF100, DF115 DF140 14002F 14002Z	(2009-13) (2001-11) (2010-12)
4 REC15626-92J01	15626-92J0/01	DF70A, DF90A DF75A DF100A, DF115A, DF140A DF115	(2014-23) (2023) (2013-21) (2011-12)
5 REC15626-96J00	15626-96J00	DF115B, DF140B DF150, DF175 DF150A, DF175A DF200A DF200	(2022-23) (2010-18) (2019-23) (2015-23) (2010-14)
6 REC15626-93J00	15626-93J00	DF225, DF250 DF250AP DF300 DF300AP DF300B DF350A	(2010-23) (2013-23) (2010-11) (2012-23) (2020-23) (2018-23)

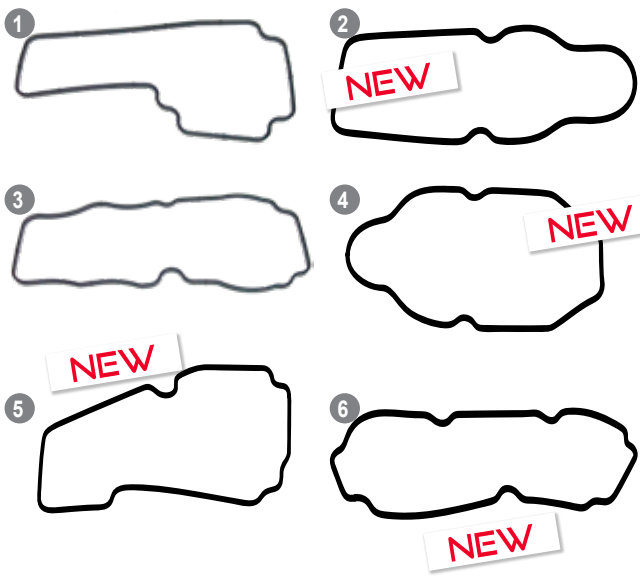



STA93008  
STA93016



GE22207



GEGC15



RECLUBE100U12

## INJEKTOR

INJEKTOR	
REF	OEM
1 REC15710-66D00	15710-66D00
2 REC15710-65D00	15710-65D00
3 REC15710-87J00	15710-87J00
4 REC15710-99E00	15710-99E00
5 REC15710-87L00	15710-87L00
6 REC15710-89L00	15710-89L00 15710-50M00
7 REC15710-82M00	15710-82M00
8 REC15710-85K00	15710-85K00
9 REC15710-96J00	15710-96J00
10 REC15710-93J00	15710-93J00
11 REC15710-82K50	15710-82K50

## INYEKTOR



## INIETTORE



## INJECTEUR



## O-RING

REF	OEM	TÓRICA	FASCIA TONDA	JOINT TORIQUE
REC15751-94900	15751-94900	DF40, DF50 DT115, DT140 DT150, DT200, DT225	X-K10 G-Y W-K3	(1999-10) (1986-00) (1998-03)

## GUIDE INJECTORS &amp; SENDERS

		MAP		IAC VALVE
DF9.9B	2013+			
DF15A	2013+	REC15710-89L00	REC18590-58M00	
DF20A	2013+			
DF25A/30A	2015+	REC15710-82M00	REC18590-58M00	
DF40	1999-10	REC15710-87J00		
DF40A	2010+	REC15710-85K00		REC18137-88L01
DF50	1999-01	REC15710-87J00		
DF50A	2010+	REC15710-85K00		REC18137-88L01
DF60 (971543-)	1998-09	REC15710-99E00		
DF60 (971544+)	1998-09	REC15710-66D00		
DF60A	2010+	REC15710-85K00		REC18137-88L01
DF70 (971543-)	1998-09	REC15710-99E00		
DF70 (971544+)	1998-09	REC15710-66D00		
DF70A	2009-11	REC15710-87L00		REC18137-87L01
DF70A	2012+	REC15710-82K50		REC18137-87L01
DF80A	2009-11	REC15710-87L00		REC18137-87L01
DF80A	2012+	REC15710-82K50		REC18137-87L01
DF90	2001-07	REC15710-65D00		
DF90A	2009-11	REC15710-87L00		REC18137-87L01
DF90A	2012+	REC15710-82K50		REC18137-87L01
DF100/15	2001-07	REC15710-65D00		
DF90/100	2008-11	REC15710-65D00	REC18590-72F21	
DF100A	2013+	REC15710-82K50		
DF115WT	2003-07	REC15710-65D00	REC18590-72F21	
DF115WT	2008+	REC15710-65D00		
DF115	2008-11	REC15710-65D00	REC18590-72F21	

## GUÍA INYECTORES Y SENSORES



## GUIDA INIETTORI E SENSORI

## GUIDE INJECTEURS ET SONDES

		MAP		IAC VALVE
DF115A	2013+	REC15710-82K50		
DF140A	2002-12	REC15710-65D00		
DF140WT K3	2003-07	REC15710-65D00	REC18590-72F21	
DF140WT K3	2008+	REC15710-65D00		
DF140A	2013+	REC15710-82K50		
DF150T/Z	2006-12	REC15710-96J00		REC18137-52D00
DF150 T/Z (G)	2013+	REC15710-96J00		REC18137-93J00
DF150AP	2017+	REC15710-96J00		
DF150AT	2019	REC15710-96J00		REC18137-93J00
DF175T/Z	2006-12	REC15710-96J00		REC18137-52D00
DF175T/Z (G)	2013+	REC15710-96J00		REC18137-93J00
DF175AP	2017+	REC15710-96J00		
DF175AT	2019	REC15710-96J00		REC18137-93J00
DF200	2004-12	REC15710-96J00		REC18137-52D00
DF200	2014+	REC15710-93J00		REC18137-93J00
DF200A	2015-17	REC15710-96J00		REC18137-93J00
DF200AP	2015+	REC15710-96J00		
DF200AT/AZ	2018+	REC15710-96J00		REC18137-93J00
DF225	2004-12	REC15710-96J00		REC18137-52D00
DF225	2014+	REC15710-93J00		REC18137-93J00
DF250AP	2013-18	REC15710-96J00		
DF250	2004-12	REC15710-96J00		REC18137-52D00
DF250	2014+	REC15710-93J00		REC18137-93J00
DF300T/Z	2007-11	REC15710-96J00		
DF300AP	2012-18	REC15710-96J00		

## CARBURATOR

## FULL CARBURATOR

REF	OEM			
1 REC13200-91J70	13200-91J70	DF4, DF5, DF6	(2002-11)	4
2 REC13200-91D21	13200-91D20/21	DT9.9, DT15 (K1-K4) DT9.9K, DT15 (KG-Y)	(2001-04) (1986-00)	2
3 REC13200-939D1	13200-939D1	DT9.9/DT15 (K1-K4) DT9.9K/DT15K (G-Y)	(2001-04) (1986-00)	2
4 REC13200-93E12	13200-93E11/12	DF9.9/DF15 (TK-3) DF9.9/DF15(R)	(1996-03) (2004-11)	4

1



2





3



4





## CARBURETOR GASKETS

REF	OEM			
1 REC13125-95210	13125-95200/10	DT115/DT140 DT20/DT25/DT30 DT25/DT30 DT40 DT40 DT55/DT65 DT75/DT85	G-Y (1986-00) G-Y (1986-00) K1-K2 (2001-02) C-W G-X (1986-99) W K1-K4 (2001-04) J-X (1988-99) J-Y (1988-00)	
2 REC13125-95J00	13125-95J00	DF20R/DF25/DF25R/DF25Q V2	(2006-13)	

## JOINTS DE CARBURATEUR



## GASKET

REF	OEM			
1 REC13251-93320	13251-93310/20	DT115/DT140 DT20/DT25/DT30 DT25/DT30 DT55/DT65 DT75/DT85	G-Y (1986-00) G-Y (1986-00) K1-K2 (2001-02) J-X (1988-99) J-Y (1988-00)	
2 REC13251-95220	13251-95210/20	DT115/DT140 DT40 DT55/DT65 DT75/DT85	G-Y (1986-00) C-W G-X (1986-99) W K1-K4 (2001-04) J-X (1988-99) J-Y (1988-00)	
3 REC13251-98100	13251-98100	DT15 DT5/DT6/DT8 DT6/DT8 DT8/DT9.9 DT9.9/DT15 DT9.9/DT15	C (1989-97) G-Y (1986-00) Y-K2 (2000-02) C J-V (1988-97) K1-K4 (2001-04) K G-Y (1986-00)	

## JOINTS

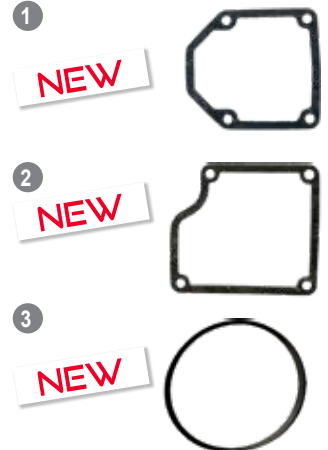

## CARBURATOR FILTER

REF	OEM	
REC15647-93J00	15647-93J00	DF90 - DF350

## FILTRE CARBURATEUR





**CARBURETOR KITS**

**KITS CARBURADORES**

**KIT CARBURATORI**

**KITS CARBURATEUR**

REF	OEM		
1 REC13910-87D00	13910-87D00	V6	2
2 REC13910-94400	13910-94400	DT40 DT65 DT85 DT140	
3 REC13910-94701	13910-94701	DT55 DT75 DT115	
4 REC13910-89J01	13910-89J01	DF25 (EXC V-TWIN)	



**FLOATS**

**BOYAS**

**GALLEGGIANTE**

**FLOTTEUR**

REF	OEM		
1 REC13250-95D01	13250-95D01	DF9.9, DF15 DF9.9, DF15(R) DT25C, DT30C DT20/DT25/DT30	T-K3 (1996-03) K-Y (2004-11) G-Y (1989-00) K1-K2 (1986-00) C-W G-X (2001-02) W K1-K4 (1986-99) J-X (2001-04) J-Y (1988-99) G-Y (1988-00) G-Y (1986-00)
2 REC13250-93012	13250-93011/12	DT40 DT40 DT55/DT65 DT75/DT85 DT115/DT140	G-Y (1986-00) Y-K2 (2000-02) C J-V (1988-97) K1-K4 (2001-04) K G-Y (1986-00) C (1989-97)
3 REC13250-98110	13250-98100	DT5/DT6/DT8 DT6/DT8 DT8/DT9.9 DT9.9/DT15 DT9.9/DT15 DT15	



**8**

**OIL**

**ACEITE**

**OLIO**

**HUILE**

**OIL FILTER**



**FILTRO DE ACEITE**

**FILTRO OLIO**

**FILTRE A HUILE**

REF	OEM		
REC16510-90J00	16510-90J00 16510-61A01/30/31 16510-61A20-MHL 16510-61A21-MHL		DF70A, DF80A, DF90A DF90, DF100, DF115 DF115WT, DF140WT-K3 K1-K11 (2009-11) (2001-11) (2001-11)
REC16510-87J00	16510-87J00/LO		DF20R, DF25-R-V2 (2006-11) DF25, DF30Y-K6 (2000-06) DF40, DF50X-K10 (1999-10) DF40A, DF50A, DF60A (2010+) DF60, DF70W-K9 (1998-09)
REC16510-82703	16510-82703 16510-92J00 16510-81420		DF140 (2002-12) DF115WT, DF140WT-K3 (2003)
REC16510-93J00	16510-96J00/10		DF150T-Z, DF175T-Z (G) (2006+) DF150AP, DF175AP, DF200AP (2018+) DF150AT, DF175AT, DF200AT (2019) DF200, DF225, DF250 (2004+) DF200A (2015+) DF300AP (2012+) DF300T-Z (2007-11) DF350A, DF325A (2018+)



REF	OEM		OEM		
1 REC16510-05240	16510-45H10 16510-05240	REC09280-54001	09280-54001 09280-56001		DF8A-AR, DF9.9A-AR (2010+) DF9.9, DF15T-K3 (1996-03) DF9.9, DF115(R) (2004-11) DF9.9B, DF15A, DF20A (2013) DF15 (2012)
2 REC16510-16H11	16510-16H11				DF4, DF5, DF6 (2017+)



## OIL DRAIN PLUG GASKET

## JUNTA TAPÓN DE CÁRTER

## GUARNIZIONE, TAPO COPPA L'OLIO

## JOINT DE VIDANGE

REF	OEM	
1 REC09168-12012	09168-12012	DF25 --> DF350
2 REC09168-12017	09168-12017	DF4 --> DF30





## OIL FILTER GUIDE

## GUÍA FILTROS DE ACEITE

## GUIDA FILTRO OLIO

## GUIDE FILTRE À HUILE

	REF
DF4, DF5, DF6	(2017+) REC16510-16H11
DF9.9, 9.9TH, 9.9A, 9.9B, 15, 15A, 20A	(1996+) REC16510-05240
DF25, 25V Twin, 25A, 30, 30A	REC16510-87J00
DF40, 40A, 50, 50A, 60, 60A, 70	REC16510-87J00
DF70A, 90A	(2009+) REC16510-90J00



	REF
DF90, 115	REC16510-90J00
DF115A, DF140A	REC16510-90J00
DF140	REC16510-82703
DF150, 175, 200A	REC16510-93J00
DF200, 225, 250, 300, 350	REC16510-93J00





## OIL GUIDE RECLUBE

## GUÍA ACEITE RECLUBE

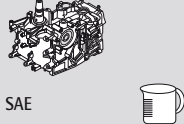
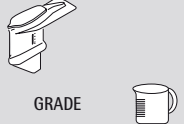
## GUIDA OLIO RECLUBE

## GUIDE D'HUILES RECLUBE

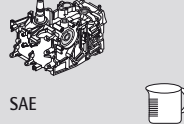
							
HP	MODEL	SAE	GRADE	SAE	GRADE		
2.5	DF2.5					GL-5	0.6
4 - 6	DF4A/ DF6A					GL-5	0.20
9.9 - 20	DF9.9T/ DF9.9TH/ DF9.9B/ DF15/ DF15A/ DF20A					GL-5	0.25
9.9	DF9.9A					GL-5	0.17
25 - 30	DF25/ DF30					GL-5	0.23
25	DF25V					GL-5	0.42
25 - 30	DF25A/DF30A					GL-5	0.33
40 - 50	DF40/ DF50					GL-5	0.61
60 - 70	DF60/ DF70					GL-5	1.05
40 - 60	DF40A/ DF50A/ DF60A					GL-5	0.61
70 - 90	DF70A/ DF90A					GL-5	0.85
90 - 115	DF90/ DF115					GL-5	1.05
115 - 140	DF115A/ DF115B/ DF140A/ DF140B/ DF115SS					GL-5	1.05
140	DF140					GL-5	1.05
150 - 200	DF150A/ DF150SS/ DF175A/ DF200SS/ DF200A					GL-5	1.10
200 - 250	DF200(V6)/ DF225/ DF250					GL-5	1.10
225 - 300	DF225T/ DF250T/ DF250SS/ DF250AP/ DF300AP					GL-5	1.10
300 - 350	DF300B/ DF350A (2017-2022)					GL-5	3.22
350	DF300BMD/ DF350AMD (2023+)					GL-5	2.85

							
HP	MODEL	SAE	GRADE	SAE	GRADE		
2.2	DT2.2					GL-4	S 0.7/ L 0.120
3.5	DT3.5					GL-4	0.85
4	DT4					GL-4	0.190
5 - 8	DT5/ DT6/ DT8					GL-4	0.240
8 - 9.9	DT8C/ DT9.9C/ DT9.9CN					GL-4	0.175
9.9 - 15	DT9.9/ DT15/ DT15C					GL-4	0.170
20 - 35	DT20/ DT25/ DT30/ DT30C/ DT35C					GL-4	0.230
40	DT40					GL-4	0.610
50-65	DT50/ DT55/ DT60/ DT65					GL-4	0.650
75 - 85	DT75/ DT85					GL-4	0.700
90 - 100	DT90/ DT100					GL-4	0.560
115 - 140	DT115/ DT140					GL-4	1.1
150 - 225	DT150/ DT175/ DT200/ DT225					GL-4	1.05



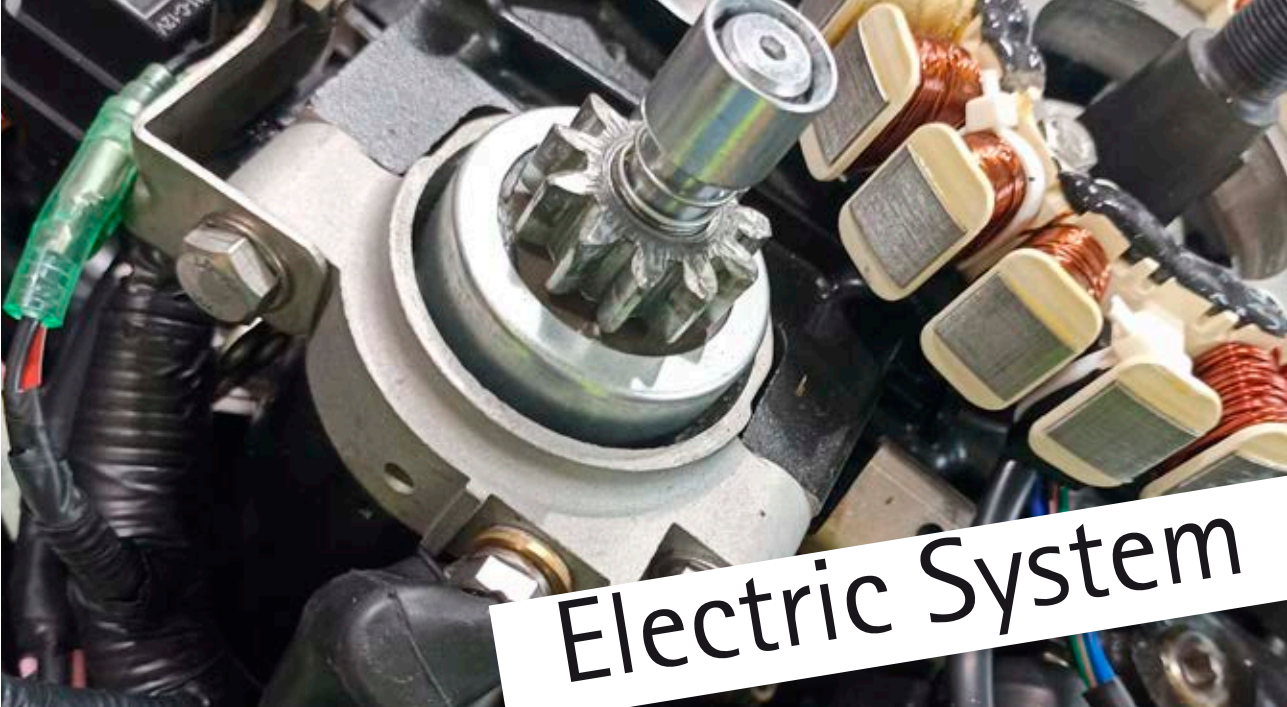

# Electric System

ELECTRIC SYSTEM

SISTEMA ELÉCTRICO

SISTEMA ELETTRICO

SYSTÈME ÉLECTRIQUE

1

➕  
OPTIONS  
INSTAL.  
P. 68

## SENSORS

### MAP

REF	OEM		
1 REC18590-72F21	18590-72F21 18590-68H00	DF70A, DF90A	(2010-23)
		DF75A	(2023)
		DF115, DF140	(2010-12)
		DF115A, DF140A	(2013-21)
		DF150, DF175	(2010-18)
		DF150A, DF175A	(2019-23)
		DF200	(2010-14)
		DF200A	(2015-23)
		DF225, DF250	(2010-23)
		DF250AP	(2013-23)
		DF300	(2001-11)
		DF300AP	(2012-23)
		DF300B	(2020-23)
		DF350A	(2018-23)
2 REC18590-58M00	18590-58M00	DF15A, DF20A	(2013-23)
		DF25A, DF30A	(2015-23)
3 REC18590-80C40	18590-80C40	DF40, DF50	(2010)
4 REC18590-68H00	18590-68H00	DF100A, DF115A	(2013)
		DF100A, DF115A, DF140A	(2014-21)
		DF140	(2002-12)
		DF200, DF225, DF250	(2014+)
		DF70A, DF80A, DF90A, DF100B	(2012+)
		DF90, DF100, DF115	(2001-11)
		DF250AP, DF350AP	(2014-15)

### IAC

REF	OEM		
REC18137-88L01	18137-88L00/01	DF40A, DF50A, DF60A	(2010+)
REC877805T	18117-84380	DF50/50 X-K10	
REC18137-77E00	18137-77E00	DF100A, DF115A, DF140	(2013-21)
		DF90, DF100, DDF115, DF140	(2001-12)
REC18137-87L01	18137-87L01	DF115B, DF140B	(2022-23)
REC18137-52D00	18137-52D00	DF150, DF175, DF200	(2004-12)
		DF225, DF250	(2010-12)
REC18137-93J00	18137-93J00	DF150, DF175	(2013-18)
		DF150A, DF175A	(2019-23)
		DF200	(2013-14)
		DF200A	(2015-23)
		DF225, DF250	(2013-23)

### IAT

REF	OEM		
1 REC13650-56B00	13650-56B00	DF60, DF70W-K9	(1998-09)
2 REC13650-52G00	13650-52G00	DF15A, DF20A	(2013-23)
		DF25A, DF30A	(2015-23)
		DF40, DF50	(2010)
		DF70A, DF90A	(2010-23)
		DF75A	(2023)
		DF115, DF140	(2010-12)
		DF115A, DF140A	(2013-21)
		DF115B, DF140B	(2022-23)
		DF150, DF175	(2010-18)
		DF150A, DF175A	(2019-23)
		DF200	(2010-14)
		DF200A	(2015-23)

## SENSORE

### MAP



### IAC



### IAT

DF150A, DF175A	(2019-23)
DF200	(2010-14)
DF200A	(2015-23)
DF225, DF250	(2010-23)
DF250AP	(2013-23)
DF300	(2010-11)
DF300AP	(2012-23)
DF300B	(2020-23)
DF350A	(2018-23)

## CAPTEURS

### MAP



### IAC



### IAT



CMP		CMP	
REF	OEM		
1	REC33220-76G02	33220-76G00/1/2	DF40, DF50 (2010) DF115 (2010) DF140 (2010-12) DF150, DF175 (G)/Z/T (2014) DF150, DF175T/Z (2006-13) DF40A, DF50A, DF60A (2009-12) DF70A, DF80A, DF90A (2012) DF40A, DF50A (2011-23) DF60A, DF70A, DF90A (2010-23)
2	REC33220-58J20	33220-58J20	DF75A (2023) DF115 (2011-12) DF115A, DF140A (2013-21) DF140B (2022-23) DF150, DF175 (2010-18) DF150A, DF175A (2019-23) DF200A (2015-23)
3	REC33220-84M10	33220-84M10	DF15A, DF20A (2013-23)
4	REC33220-64L00	33220-64L00	DF25A (2019-23)
5	REC33220-50M00	33220-50M00	DF25A (2015-18) DF30A (2015-23) DF200 (2010-14) DF225, DF250 (2010-23) DF250AP (2013-23)
6	REC33220-98J00	33220-98J00 33220-69J00	DF300 (2010-11) DF300AP (2012-23) DF300B (2020-23) DF350A (2018-23)



OIL PRESSURE		PRESIÓN DE ACEITE	
REF	OEM		
1	REC37820-98J00	37820-98J00	DF250AP, DF300AP (2013-23) DF250AP/ATSS, DF300AP (2024-25) DF8, DF20 (1996-17)
2	PAF15-07010100	37820-93E10/11	DF15 (2010-12) DF15A (2013-15) DF20A (2013-14) DF9.9B, DF15A, DF20A (2015-17) DF9.9, DF15 T-K3 (1996-03)
3	REC37820-80002	37820-80001/2 37820-93E00	DF15A (2016-23) DF20A (2015-23) DF20, DF25, DF25R V2 (2006-11) DF25, DF30 Y-K6 (2000-06) DF25A, DF30A (2015-17) DF25V (2010-14) DF25A, DF30A (2015-23)

PRESIONE DELL'OLIO		PRESSION D'HUILE	
REF	OEM		
4	REC37820-99E02	37820-99E00/1/2	DF40, DF50 (2010) DF40A, DF50A (2011-23) DF60A, DF70A, DF90A (2010-30) DF75A (2023) DF115, DF140 (2010-12) DF115A, DF140B (2013-23) DF140A (2013-21) DF150, DF175 (2010-18) DF150A, DF175A (2019-23) DF200 (2010-14) DF200A (2015-23) DF225, DF250 (2010-23) DF300 (2010-11) DF300B (2020-23) DF350A (2018-23)



WATER TEMPERATURE		TEMPERATURA DEL AGUA	
REF	OEM		
1	REC34830-87J20	34830-87J20	DF8 - 350 (2010-14) DF25V (2010) DF40, DF50 (2011-23) DF40A, DF50A (2010-23) DF60A, DF70A, DF90A (2010-23) DF75A (2023) DF115, DF140 (2010-12) DF115A, DF140A (2013-21) DF115B, DF140B (2022-23)
2	REC13640-32G20	13640-32G20	DF9.9B/DF15A/DF20A (2016+) DF25A, DF30A (2015-23)

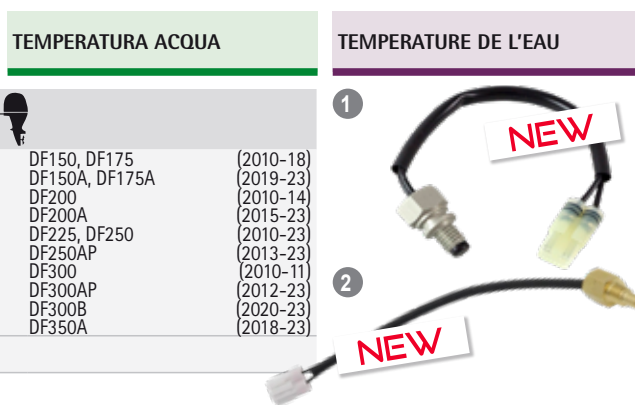

OXYGEN		OXÍGENO	
REF	OEM		
REC18213-98J30	18213-98J00/10/20/30	DF115A, DF140A (2013-21) DF115B (2022-23) DF150A, DF175A (2019-23) DF250AP (2013-23) DF300AP (2012-23)	

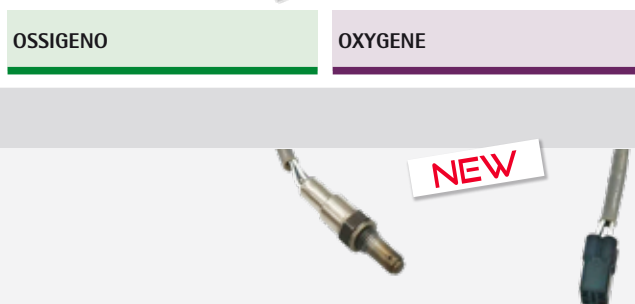

COILS

BOBINAS

BOBINE

BOBINES

IGNITION		IGNICIÓN	
REF	OEM		
1 REC33410-94J00	33410-94J00	DF9.9/DF15(R) DF15	(2004-12) (2010-12)
2 REC33410-94400-000	33410-94400-000 33410-93E10	DF9.9, DF15T -K3 DF9.9, DF15(R) DT40C-W-G-X	(1996-03) (2004-10) (1986-99)
3 REC33410-95J00	33410-95J00	DT40W-K1-K4	(2001-04)
4 REC33410-94L00	33410-94L00	DF25/25R/25Q V2 DF25V	(2006-13) (2010-14)
5 REC33410-87J01	33410-87J00/01	DF25A, DF30A	(2015-23)
6 REC33410-87L00	33410-87L00	DF40/50 X-K10	(1999-10)
7 REC33410-90J00	33410-90J00	DF40A/50A/60A DF70A/75A/80A/90A DF100B DF40A/50A DF60A/70A/90A DF75A	(2010+) (2012+) (2012+) (2011-23) (2010-23) (2023)
8 REC33410-89L11	33410-89L00/10/11	DF100A/115A/140A DF140 DF90/100/115 DF115 DF115A, DF140A DF140	(2013+) (2002-12) (2001-11) (2010-12) (2013-21) (2010-14)
9 REC33410-96L00	33410-96L00	DF9.9B DF15A, DF20A DF150/175/200 AT/AZ DF150AP/175AP/200AP DF150AT/175AT/200AT DF200A/AP DF200AT/AZ DF115B, DF140B DF150A DF175A DF200A	(2013+) (2013-23) (2020+) (2017+) (2019+) (2015-17) (2018) (2022-23) (2019-23) (2020-23) (2015-23)
10 REC33410-93J00	33410-93J00	DF150T/Z, DF175T/Z DF200/225/250 DF250AP, DF300AP DF300T/Z DF150, DF175 DF175A DF200 DF225, DF250 DF250AP DF300 DF300AP	(2006-18) (2004+) (2012+) (2007-11) (2010-18) (2019) (2010-14) (2010-23) (2013-23) (2010-11) (2012-23)
11 REC32140-94400	32140-94400	DT40C-WG-X DT40W K1-K4	(1986-99) (2001-04)
12 REC32140-96310	32140-96310	DT20, DT25, DT30G-Y DT25, DT30 K1-K2	(1986-00) (2001-02)
13 REC32140-93900	32140-93900	DT9.9, DT15K1-K4 DT9.9K, DT15K-G-Y	(2001-04) (1986-00)

CDI		CDI	
REF	OEM		
1 REC32900-96340	32900-96340	DT20, DT25, DT30G-Y	(1986-00)
2 REC32900-93903	32900-93902/3	DT9.9K, DT15G-Y	(1986-00)

REGULATOR-COIL		REGULADOR-BOBINA	
REF	OEM		
REC32900-94480	32900-94401/21/80	DT40C-W-X-G	(1986-99)

AVVIAMENTO



CDI



REGOLATORE-BOBINA

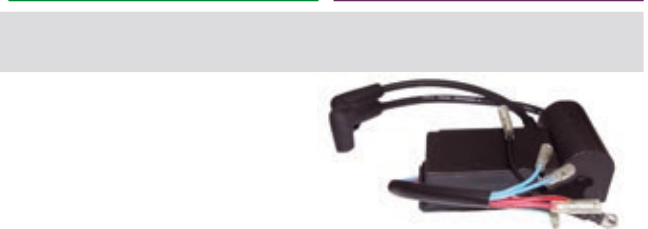



## SPARK

## BUJÍAS

## CANDELE

## BOUGIES

			
DT2	1986-90	NGKBR4HS	
DT2	1977-96	NGKB5HS	
DT2	1991-99	NGKBR5HS	
DT2.2	1992	NGKBR5HS	
DT2.2	1997	NGKB5HS	
DT3.5	1979-84		CHAQL87YC
DT4	1985-98		CHAQL87YC
DT4	1988-92	NGKBP5HS	
DT4	1993-01	NGKBP5HS	
DT4.5		NGKBR6HS	
DT4L/S	1994	NGKBP5HS	
DT4L/S	-1993	NGKBP5HS	
DT4.5	1977		CHAQL86C
DT5	1978-83		CHAQL87YC
DT5	1986-92	NGKBP6HS	
DT5	1993-94	NGKBP6HS	
DT5	1995-00	NGKBR6HS	
DT5W	1986-92	NGKBR6HS	
DT5Y	1998-01	NGKBP7HS-10	CHAQL82YC
DT6	1984-97		CHAQL87YC
DT6	1986-92	NGKBR6HS-10	
DT6	1993-02	NGKBR6HS	
DT6	-1985	NGKB6HS	
DT6	1995-99	NGKBR6HS-10	
DT6	1998-01		CHAQL87YC
DT6S/5PS	-1992	NGKB6HS	
DT7.5		NGKBR6HS	
DT7.5	1977-79		CHAQL86C
DT8	1980-87		CHAQL87YC
DT8	1986-02	NGKBP6HS	
DT8C	1988-97	NGKBR6HS-10	
DT9	1977-79		CHAQL86C
DT9	1993		CHAQL86C
DT9		NGKBR6HS-10	
DT9.9	1986-99	NGKBR7HS-10	
DT9.9	1977-78	NGKB7HS	
DT9.9	1879-84	NGKBR6HS	
DT9.9	1976	NGKB6HS	
DT9.9C	1983-97		CHAQL82C
DT9.9C	1988-97	NGKBR6HS-10	
DT9.9E	1982	NGKB6HS	
DT9.9E	1984	NGKB7HS	
DT9.9E	1983	NGKBR7HS-10	
DT9.9K	1985-86	NGKB6HS	
DT9.9K	-1985	NGKBR6HS	
DT9.9K	1986-90	NGKB6HS	
DT9.9P	-1983	NGKBP6HS	
DT15	1983-88		CHAQL86C
DT15	1986-02	NGKBR7HS-10	
DT15C	1989-97	NGKBR7HS-10	CHAQL82C
DT15K	-1985	NGKBR6HS	
DT15K	1986	NGKB6HS	
T16	1977-82		CHAQL86C
DT20	1977-88		CHAQL82C
DT20	1997-00	NGKBR7HS-10	
DT20/P	-1985	NGKBR7HS	
DT20/P	1986	NGKBR7HS-10	
DT20K	-1985	NGKBR7HS-10	
DT20K	1986-87	NGKB7HS-10	
DT25	-1985	NGKBR7HS	
DT25	2000-01	NGKBR7HS-10	
DT25C	1977-00		CHAQL82C
DT25C	1989-97	NGKBR7HS-10	
DT25E	1983-85	NGKBP7HS-10	
DT25E	-1982	NGKB7HS	
DT25E/K	1986	NGKBR7HS-10	
DT28/P/E		NGKB7HS	
DT30	1986	NGKBR7HS-10	
DT30	1983-85	NGKBR7HS-10	
DT30C	1988-00	NGKBR7HS-10	
DT30C/35	1989		CHAQL82C
DT30E	1983	NGKBR7HS-10	
DT40	-1983	NGKBR8HS	NGKBR8HIX
DT40	1980-98		CHAQL78C
DT40C	1986-99	NGKBR8HS-10	
DT40C/CR/TC	1998	NGKBR8HS-10	

			
DT40W	1995	NGKB7HS-10	
DT40WK	1998	NGKB7HS-10	
DT40WK	-1997	NGKB7HS	
DT48M	2001	NGKBR8HS-10	
DT48M	-2000	NGKBR8HS	NGKBR8HIX
DT50	1979-83	NGKBR8HS	NGKBR8HIX
DT50	-1978	NGKB7HS	
DT50	1984-89	NGKBR8HS-10	
DT50	1997-84		CHAQL78C
DT50ACR	1994-96	NGKBR8HS-10	
DT50ACR	1993	NGKBR8HS	NGKBR8HIX
DT50C	1984-00	NGKBR8HS-10	
DT50K		NGKB7HS	
DT50/M	1986-89	NGKBR8HS-10	
DT50/M	-1985	NGKBR8HS	NGKBR8HIX
DT50/M	2001	NGKBR8HS-10	
DT55	1985-97		CHAQL78C
DT55C	1988-98	NGKBR8HS-10	
DT55M/MQ	-2000	NGKBR8HS	NGKBR8HIX
DT55M/MQ	2001	NGKBR8HS-10	
DT55TC/CRQ	1998	NGKBR8HS-10	
DT60		NGKBR8HS-10	
DT60	1983-84		CHAQL78C
DT65	1978-97		CHAQL78C
DT65/T	-1983	NGKBR8HS	NGKBR8HIX
DT65C	1988-99	NGKBR8HS-10	
DT65TC	1994-95	NGKBR8HS-10	
DT75	1983-97		CHAQL78C
DT75/85	1990-92	NGKBR8HS	NGKBR8HIX
DT75/85	1993-00	NGKBR8HS-10	
DT75C	2001	NGKBR8HS-10	
DT75C	1993-00	NGKBR8HS	NGKBR8HIX
DT75M	2001	NGKBR8HS-10	
DT75M	-2000	NGKBR8HS	NGKBR8HIX
DT75TC	-2000	NGKBR8HS	NGKBR8HIX
DT75TC	2001	NGKBR8HS-10	
DT85	1979-97		CHAQL78C
DT85	1998		CHAQL78C
DT85	-1992	NGKBR8HS	NGKBR8HIX
DT85C	2001	NGKBR8HS-10	
DT85C	1993-00	NGKBR8HS	NGKBR8HIX
DT85C	-1992	NGKBR8HS	NGKBR8HIX
DT85M	2001	NGKBR8HS-10	
DT85M	-2000	NGKBR8HS	NGKBR8HIX
DT85MQ	1995-96	NGKBR8HS-10	
DT85Q	2001	NGKBR8HS-10	
DT85Q/TC	-2000	NGKBR8HS	NGKBR8HIX
DT85TC/W	2001	NGKBR8HS-10	
DT85W	-2000	NGKBR8HS	NGKBR8HIX
DT85WT	2001	NGKBR8HS-10	
DT85WT	1995-96	NGKBR8HS-10	
DT90	-2000	NGKBR8HCS-10	
DT90	2001	NGKBR8HS-10	
DT90TC	1996-97	NGKBR8HS	NGKBR8HIX
DT90TC	-1995	NGKBR8HCS-10	
DT90TC	1998	NGKBR8HS-10	
DT90 V4	1989-97		CHAQL78C
DT100	2001	NGKBR8HS-10	
DT100	1996-00	NGKBR8HS-10	
DT100	1990-95	NGKBR8HCS-10	
DT100	2000	NGKBR8HCS-10	
DT100 V4	1989-01		CHAQL78C
DT100TC	-1995	NGKBR8HCS-10	
DT100TC	1998	NGKBR8HS-10	
DT100TC	1996-97	NGKBR8HS	NGKBR8HIX
DT115 Carb	1981-97		CHAQL78C
DT115	-1990	NGKBR8HS	NGKBR8HIX
DT115	1992	NGKBR8HCS-10	
DT115 EFI	1996-01		CHAQL78C
DT115C	1991-93	NGKBR8HCS-10	
DT115C	-1990	NGKBR8HS	NGKBR8HIX
DT115C	2001	NGKBR8HS-10	
DT115S	1996	NGKBR8HS-10	
DT115S EFI	1998		CHAQL78C
DT115STC	1996	NGKBR8HS-10	
DT115TC	-1988	NGKBR8HS-10	

2		NGK	CHAMPION
DT115TC		NGKBR8HCS-10	
DT115TC (EFI)		NGKBR8HS-10	
DT140 Carb	1981-96		CHAQL78C
DT140	1992	NGKBR8HCS-10	
DT140	-1990	NGKBR8HS	NGKBR8HIX
DT140 EFI	1996	NGKBR8HS-10	
DT140 EFI	1997-01		CHAQL78C
DT140C	1991-96	NGKBR8HCS-10	
DT1140C	-1990	NGKBR8HS	NGKBR8HIX
DT140C EFI	1997	NGKBR8HCS-10	
DT140T	-2000	NGKBR8HCS-10	
DT140T	2001	NGKBR8HS-10	
DT140TC	-2000	NGKBR8HCS-10	
DT140TC EFI		NGKBR8HS-10	
DT150	1987-02	NGKBR8HS-10	
DT150G		NGKBR8HS-10	

2		NGK	CHAMPION
DT150S/SS/STC		NGKBR8HS-10	
DT150TC	1989	NGKBR8HS-10	
DT150TC EFI		NGKBR8HS-10	
DT150 V6 EFI	1986-94		CHAQL78C
DT175	1989-02	NGKBR8HS-10	
DT175TC	1989	NGKBR8HS-10	
DT175 V6	1991-93		CHAQL78C
DT200	1989-02	NGKBR8HS-10	
DT200 EFI	1986		CHAQL78C
DT225 EFI	1991		CHAQL78C
DT200G/T		NGKBR8HS-10	
DT200TC	1989	NGKBR8HS-10	
DT200V		NGKBR8HS-10	
DT225	1991-02	NGKBR8HS-10	
DT225TC		NGKBR8HS-10	
DT225TCL EFI		NGKBR8HS	NGKBR8HIX

4		NGK	CHAMPION	OEM
DF2.5, DF6		NGKCR6HSA		09482-00406
DF4, DF6	2003-04		CHARN9YC	
DF4, DF6	2003-10	NGKBPR6ES		09482-00299
DF4, DF6	2011+	NGKCPR6EA-9		09482-00L04
DF9.9A		NGKCR6E		09482-00528
DF9.9, DF15	1997-04		CHARA8HC	
DF9.9, DF15	2004+	NGKD CPR6E		09482-00446
DF9.9, DF15	2004-10	NGKBKR6E		09482-00427
DF9.9, DF15	2010+	NGKCPR6EA-9		09482-00L04
DF25, DF30	2000-04		CHARA8HC	
DF9.9B, DF15A, DF20A	2018+	NGKMR6K-9		09482-00661
DF25A, DF30A	2019+	NGKMR6K-9		09482-00661
DF25 V-TWIN		NGKBKR6E		09482-00427
DF40, DF50		NGKD CPR6E		09482-00446
DF40, DF50	1999-04		CHARA8HC	
DF60, DF70		NGKBPR6ES		09482-00299
DF60, DF70	1998-04		CHARN9YC	
DF40A, DF50A, DF60A, DF70A, DF90A		NGKD CPR6E		09482-00446
DF90, DF115, DF140, DF150, DF175		NGKBKR6E		09482-00427
DF90/115	2001-04		CHARC9YC	
DF140	2002-04		CHARC9YC	
DF200A/AP		NGKLR6E		09482-00649
DF200, DF225, DF250, DF200SS, DF300		NGKBKR6E		09482-00427
DF300B, DF350A, DF325A		NGKILZKR7D8		09482-00642



REC004

CHAPR05U

4

STARTER

ARRANQUE





AVVIAMENTO

DEMARRAGE

STARTER	MOTORES DE ARRANQUE	MOTORINI AVVIAMENTO	DÉMARREUR		
REF	OEM				
1 REC31100-95J01	31100-95J00/01 31100-94J10/20/21/22	DF8A, DF9.9A (AR) DF9.9, DF15 (R) DF9.9B, DF15A, DF20A DF15 DF20R, DF25, DF25R-V2 DF40, DF50X-K10 DF40A, DF50A, DF60A DF8A, DF8AR, DF9.9A DF9.9B, DF15A, DF20A, DF40A, DF50A, DF60A DF8A/8AR, DF9.9A/AR DF9.9/DF15(R) DF9.9B/DF15A/DF20A DF40/DF50 DF40A/DF50A/DF60A DF9.9, DF15 DF25, DF30Y-K6 DF25A, DF30A DT20, DT25, DT30G-Y DT25, DT30 DT40C-WG-X	(2010-16) (2004-11) (2013) (2012) (2006-11) (1999-10) (2010-18) (2020+) (2019-23) (2010-19) (2004-12) (2013-18) (1999-10) (2012-18) (1996-11) (2000-06) (2015+) (1986-00) (1998-00) (1986-99)	4 12V 9 CCW 12V 1.2kW 9 CCW PMGR 12V 1.4kW 9 CCW PMGR 2-4 12V 0.6 kw 9 CCW	1 2 3 4

NEW



REF	OEM				
5 REC31100-89J00	3100-89J00	DF25, DF30	Y-K6	(2000-06)	12V 0,6kW 8
6 REC31100-87J11	31100-87J10/11	DF40, DF50 DF60, DF70	X-K10 W-K9	(1999-10) (1998-09)	12V 1.0kW 8
7 REC31100-87J00	31100-87J00/10/11 31100-87500	DF40, DF50X-K10 DF60, DF70W-K9		(1999-10) (1998-09)	4 12V 8
8 REC99999-03249	31100-95240/2/3	DT50 DT65		(1980-83) (1980-82)	2 12V 1kW 9 CCW
9 REC31100-94702	31100-94702	DT55, DT65X-J		(1988-99)	2 9
10 REC31100-98L10	31100-98L10	DF70A, DF80A, DF90A, DF100B DF150, DF175, DF200AP(AT) DF200AT/AZ DF200, DF225, DF250 DF250A0, DF300AP, DF325A, DF350A DF300B DF70A, DF80A, DF90A DF100B, DF150AP, DF175AP, DF200AP DF150AT, DF175AT, DF200AT DF150T/Z, DF175T/Z DF150G/T/Z, DF175G/T/Z DF200, DF225, DF250 DF200AT/AZ DF250AP, DF300AP DF300T/Z DF300AP DF350, DF325A		(2018+) (2018+) (2018) (2019+) (2018+) (2020+) (2009+) (2018+) (2019) (2018) (2006+) (2004-12, 2019) (2018) (2018+) (2007-11) (2012) (2018+)	4 12V 1.4 kW 9 CW
12 REC31100-95601	31100-95600/1 31100-95310/12/13 31100-95521 31100-87000	DT75-DT85Y-J		(1988-00)	2 9
13 REC31100-92E00	31100-87D00/10 31100-92E00	DT90, DT100L - Y DT150, DT200, DT225W-K3 V6H-Y		(1990-00) (1998-03) (1987-00)	2 12V 0.9kW 8
14 REC31100-90J01	31100-90J00/1	DF90, DF100, DF115K1-K11 DF100A, DF115A, DF140A DF140 DF140A		(2001-11) (2013+) (2002-12) (2013)	4 12V 1.4kW 9 CCW
15 REC31100-92J00	31100-92J00	DF100C/A, DF115B/A/BG/BZG, DF140BG/BGZ/B/A		(2016+)	12V 1.4 kW 9
16 REC31100-94610	31100-94600/1/10 31100-94500/10/11/12	DT115, DT140G-Y		(1986-00)	2 12V 0.9kW 9 CCW

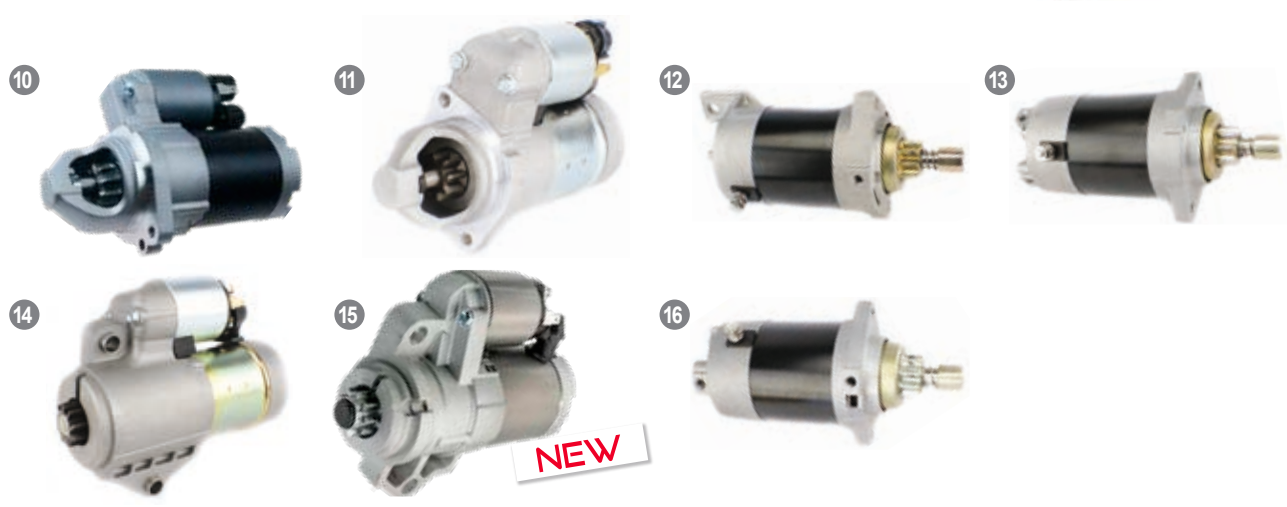

**SOLENOID FOR STARTERS**

**SOLENOIDE PARA MOTOR DE ARRANQUE**

**SOLENOIDE PER MOTORINI AVVIAMENTO**

**SOLENOIDE POUR DEMARREUR**

REF	OEM	
1 REC89-825096T01	38410-89J00 38410-94550/1/2 31800-94400/1	DT40C-W DT55, DT65 DT75, DT85 DF25, DF30 DT90, DT100 V6 DT115, DT140 DT150, DT200, DT225 DF40, DF50 DF115WT, DF140WT DF90, DF100, DF115 DF60, DF70 DF140
2 REC31800-94L01	31800-94L01	G-X (1986-99) J-X (1988-99) J-Y (1988-00) Y-K6 (200-06) L-Y (1990-00) H-Y (1987-00) G-Y (1986-00) W-K3 (1998-03) X-K10(1999-10) K3 (2003) (2001-11) W-K9 (1998-09) (2002-11)
		DF25A, DF30A (2015-23)



OPTIONS  
INSTAL.  
P. 66



REGULATORS AND RECTIFIERS GUIDE

GUÍA REGULADORES Y RECTIFICADORES

GUIDA REGOLATORE E RETTIFICATORE

GUIDE REGULATEURS ET RECTIFIEURS

REF	OEM		
1 REC32800-99J00	32800-99J00	DF8A, DF9.9A/AR	(2012+)
2 REC32800-95D01	32800-95D00/1 32800-95720	DF9.9, DF15 DT4-DT140 V6	(1996-11) (1986-04) H-Y (1987-00)
3 REC32800-94J11	32800-94J10/11	DF9.9B, DF15A, DF20A	
4 REC32800-94J01	32800-94J00/01	DF9.9, DF15 DF15	R (2004-11) (2012)
5 REC32800-89L01	32800-89L00/01	DF9.9B, DF15A, DF20A	
6 REC32800-89J00	32800-89J00	DF25, DF30 Y-K6	
7 REC32800-89J11	32800-89J10/11	DF25, DF30 Y-K6	
8 REC32800-38F10	32800-38F10	DF40, DF50X-K10	

REF	OEM		
9 REC32800-88L00	32800-88L00	DF40A, DF50A, DF60A	
10 REC32800-87J10	32800-87J10	DF40, DF50X-K10	
11 REC32800-87L00	32800-87L00	DF70A, DF80A, DF90A, DF100B	
12 REC32800-90J00	32800-90J00	DF90, DF100, DF115, DF140	(2001-11)
13 REC32800-90J20	32800-90J20	DF90, DF100, DF115, DF140	(2001-11)
14 REC32800-94620	32800-94610/20	DT115, DT140	
15 REC32800-92E20	32800-92E20	DT150, DT200, DT225 W-K3	
16 REC32800-93J03	32800-93J01/2/3	DF200, DF225, DF250	
17 REC32800-98J01	32800-98J01	DF250AP, DF300AP DF300T/Z	(2012+) (2007-11)





TRIM SYSTEM

SISTEMA DE TRIM

SISTEMA DI TRIM

SYSTÈME DE TRIM

1

TRIM, TILT & POWER TRIM

TRIM, TILT & POWER TRIM

TRIM, TILT & POWER TRIM

TRIM, TILT & POWER TRIM

TRIM		MOTOR TRIM		MOTORINO TRIM				MOTEUR DE TRIM	
REF	OEM								
1	REC38100-97E00-OED	38100-97E00-OED	DT40C-W G-X	(1986-99)	12V	4	2	2	
2	REC38100-87J00	37100-87J00-OEP 38100-87JOEP	DF40, DF50X-K10 TMY99-00	(1999-10)	12V	4	2	4	
3	REC38100-87J12	38100-87J11/20	DF40, DF50X-K10 DF40, DF50	(1999-10) (2010)	12V	4	2	4	
4	REC36120-ZW4-H12	38100-88L00/11/12	DF40A, DF50A DF60A	(2011-23) (2010-23)	12V	4		4	
5	REC38100-99E01-OEP	38100-99E01-OEP/OED 38100-99E01-00	DF60, DF70W-K9 DT55, DT65J-X DT75, DT85J-Y	(1998-09) (1988-99) (1988-00)	12V	2	2	2-4	
6	REC36120-ZY6-013	38100-93J11/13/30/40	DF60, DF70 W-K9	(1998-09)	12V	4		4	
7	REC36120-ZY3-013	38100-90J30/40 38100-93J14	DF60, DF70W-K9 DF200, DF225, DF250	(1998-09) (2012+)					
8	REC36120-ZY9-003	38100-87L00/1/2/3	DF70A DF90A	(2010-18) 2010-16	12V	4		4	
9	REC38100-87E10-OED	38100-87D00/01T/02H 38100-87E10-OED 38100-87D01-OED/02M	DT90, DT100L-Y	(1990-00)	12V	3	3	2	



REF	OEM							
10	REC38100-96J00	38100-92J01/02/10/12 38100-93J02 38100-96J00/01	DF90, DF100, DF115K1-K11 DF200, DF225, DF250 DF300T/Z DF150T/Z DF115, DF140 DF115A, DF140A DF115B, DF140B DF150, DF175 DF150A, DF175A	(2001-11) (2004-11) (2007-11) (2006-12) (2010-12) (2013-21) (2022-23) (2010-18) (2019-23)	12V	4	2	4
11	REC38100-87D10-OED	38100-87D10-OED/OIT 38100-87D10-35J 38100-92E00-OED 38100-87E20-OED	DT150, DT200, DT225W-K3 V6H-Y	(1998-03) (1987-00)	12V	3	2	2
12	REC38100-98L00	38100-98L00/01/02	DF350A DF300B	(2018-23) (2020-23)				
13	REC38100-87L12	38100-87L12/13	DF70A DF75A DF90A	(2019-23) (2023) (2017-23)				

10



11



12



13



COMPLETE POWER TRIM ASSEMBLY

POWER TRIM COMPLETO

MOTORINO POWER TRIM COMPLETO

POWER TRIM COMPLET

REF	OEM		
1	REC63P-43800-20	48600-94511-OED	3 RAM 115-225HP SHOWA SYSTEM
2	REC48503-93J12	48503-93J10/12 48503-94900-OED	DT115, DT140G-Y (1986-00) DF90 --> DF250 Complete 3-Ram T/T System SHOWA SYSTEM

1



2



WIRING HARNESS

INSTALACIÓN ELÉCTRICA

INSTALLAZIONE ELETTRICA

INSTALLATION ELECTRIQUE

CONVERSION KIT  
- Converts 3-wire Tilt and Trim motors to 2-Wire design

KIT CONVERSIÓN  
Sustituye de 2 a 3 cables.

KIT CONVERSIONE  
Sustituisce da 2 a 3 cavi.

FAISCEAU CONVERTISSEUR 3 A 2 FILS

REF

REC84-819514T26



TRIM PARTS

DESPIECES TRIM

ESPLOSO TRIM

PIÈCES TRIM

PISTON TRIM PARTS

DESPIECE PISTÓN TRIM

PARTI PISTONE TRIM

PIECES VERIN DE TRIM

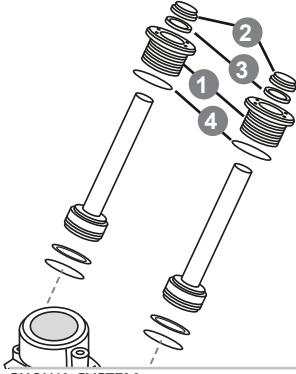

SHOWA SYSTEM 2010+

REF	OEM	CAP FOR SHOWA SYSTEM	TAPÓN PARA SHOWA SYSTEM	TAPPO PER SHOWA SYSTEM	NEZ DE VERIN DE TRIM POUR SHOWA SYSTEM	UN.
1 REC48630-96J03	48630-96J03					2
1 REC48630-94900	48630-94900					2
1 REC48630-92J00	48630-92J00					2
2 REC64E-43822-00		SEAL OIL	SELLO	PARAOLIO	JOINT TORIQUE	2
3 REC64E-4384J-00		SEAL OIL	SELLO	PARAOLIO	JOINT TORIQUE	2
4 REC6G5-43864-00		SEAL OIL	SELLO	PARAOLIO	JOINT TORIQUE	2

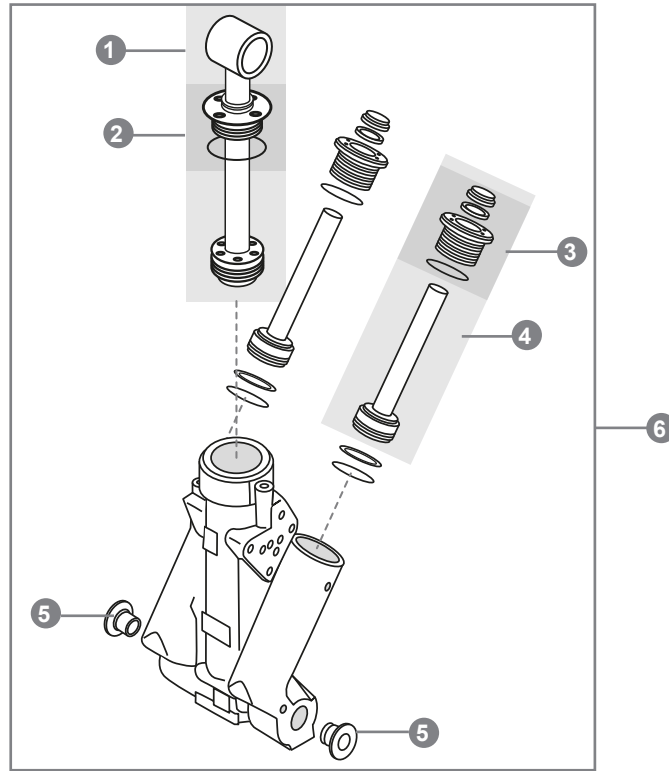

	1	2	3	4	5	6
DF115, DF140, DF150, DF175 2010-24						
DF200, DF250 2010-11	REC48401-93J11	REC64E-43811-02	REC48630-96J00	REC64E-43820-05	REC48326-95E00	REC48503-93J12
DF200 2012-24						
DF200X 2012-24						
DF225 2010-24	REC48401-98L00		REC48630-98L01	REC48610-98L00		
DF250 2016-24	REC48401-93J11	REC64E-43811-02	REC48630-96J00	REC64E-43820-05	REC48326-95E00	REC48503-93J12
DF250X 2012-24	REC48401-98L00		REC48630-98L01	REC48610-98L00		
DF300L 2016-24	REC48401-93J11	REC64E-43811-02	REC48630-96J00	REC64E-43820-05	REC48326-95E00	
DF300X 2016-24						
DF300, DF350 Duo Prop 2018-24	REC48401-98L00		REC48630-98L01	REC48610-98L00		

TRIM PISTON ASSY

PISTÓN TRIM COMPLETO

PISTONE TRIM COMPLETO

VERIN TRIM COMPLET



REF	OEM
REC48610-98L00	48610-98L00 48610-93J00/1
REC64E-43820-05	48601-94900



TRIM CAP		TAPÓN DE TRIM		TAPPO DE TRIM		NEZ DE VERIN DE TRIM	
REF	OEM						
1 REC48630-94900	48630-94900	DF60, DF70W-K9 DT115, DT140		G-Y	(1998-09) (1986-00)		
2 REC48630-96J03	48630-96J01/2/3	DF100A, DF115A, DF140A DF140 DF150T/Z, DF175T/Z (G)		(2013-16) (14002F/14002Z)	(2000-12) (2006-16)		
3 REC48630-92J00	48630-92J00	DF150T DF150AP, DF175AP, DF200AP DF200, DF225, DF250 DF200A/AP		(881864+) (2017+)	(2004-16) (2015-16)		
4 REC48630-96J00	48630-96J00	DF115WT, SF115WT K3, DF140WT, DF140WT DF140			(2003) (2002-11)		
5 REC48630-93J00	48630-93J00	DF200, DF225, DF250			(2004-11)		
6 REC48630-98L01	48630-98L00/1	DF250AP, DF300AP DF200, DF225, DF250 DF300T/Z DF350A, DF325A DF300B		(25003P/30002P)	(2012-18) (2004+) (2007-11) (2018+) (2020)		
7 REC64E-43811-02	48401-96J02						

TILT PISTON ASSY		PISTÓN TILT COMPLETO		PISTONE TILT COMPLETO		VERIN TILT COMPLET	
REF	OEM						
REC48401-93J11	48401-93J11 48401-93L00						
REC48401-98L00	48401-98L00 48400-93J07 48400-98J03						

3

SWITCHS & SONDAS		INTERRUPTORES Y SENSORES		INTERRUTTORI E SENSORI		INTERRUPTEURS ET CAPTEURS	
TRIM SWITCH, SIDE CONTROLS		INTERRUPTOR DE TRIM MANDOS LATERALES		INTERRUTTORE TRIM, COMANDO LATERALE		INTERRUPTEUR TRIM BOITIER LATERAL	
REF	OEM						
REC37850-90J06	37850-90J00/1/2/3/4/5/6			DF25 -->DF250			
TRIM SWITCH, SINGLE CONTROLS		INTERRUPTOR DE TRIM, MANDOS CONSOLA SIMPLE		INTERRUTTORE TRIM, PANNELLO SINGOLO		INTERRUPTEUR TRIM, CONSOLE SIMPLE	
REF	OEM						
REC37850-93J10	37850-93J10			DF8 -->DF250			
TRIM SWITCH DUAL CONTROLS		INTERRUPTOR DE TRIM MANDOS CONSOLA DUAL		INTERRUTTORE TRIM PANNELLO DOPPIO		INTERRUPTEUR TRIM CONSOLE DOUBLE	
REF	OEM						
REC37220-92E00	37220-92E00			DF40 -->DF250			

TRIM RELAY		RELÉ DE TRIM	RELE TRIM	RELAIS DE TRIM
REF	OEM			1
1 REC38410-93J21	38410-93J20/21	DF15A, DF20A DF25A, DF30A DF90A DF115 DF115A, DF140A DF115B, DF140B DF150A, DF175A DF200A DF300B DF350A	(2013-23) (2015-23) (2019-23) (2011-12) (2013-21) (2022-23) (2019-23) (2015-23) (2020-23) (2018-23)	4
2 REC38410-93J12	38410-93J12/11/10/00	DF40, DF50 DF40A, DF50A DF60A, DF70A, DF75A DF90A, DF150, DF175 DF140 DF200 DF225, DF250 DF250AP DF300 DF300AP	(2010) (2011-23) (2010-23) (2023) (2010-18) (2010-12) (2010-14) (2010-23) (2013-23) (2010-11) (2012-23)	4
3 REC6E5-8195A-01	38410-94550/51/52	DT40-DT225 DF40-DF115 DF115	(2010)	2-4 12V



TRIM SONDES		SENSORES DE TRIM	SENSORI TRIM	CAPTEUR TRIM
REF	OEM		1	2
1 REC34801-94710	34801-94700/10	DF25, DF30 Y-K6 DF40, DF50 X-K10 DF60, DF70 W-K9 DT55, DT65 J-X DT75, DT85 J-Y	(2000-06) (1999-10) (1998-09) (1988-99) (1988-00)	
2 REC34801-99E04	34801-99E01/2/3/4	DF40, DF50, DF115 DF140 DF150, DF175	(2010) (2010-12) (2010-18)	
3 REC34840-98J03	34840-98J00/1/2/3	DF40A, DF50A, DF60A DF100A, DF115A DF115 DF115B DF140A DF140B, DF115B, DF100C DF200, DF225 DF250AP, DF300AP DF250 DF300B, DF325A, DF350A DF300T/Z DF300AP	(2010+) (2024-25) (2015+) (2010-25) (2018+) (2007-11) (2013)	
4 REC34840-98J11	34840-98J11	DF40A, DF50A, DF60A DF70A, DF75A, DF80A, DF90A, DF100B DF70A, DF90A DF150, DF175, DF200AT/AZ DF150A, DF175A, DF200A DF150AP, DF175AP, DF200AP DF150AT, DF175AT, DF200AT DF150T/G/Z, DF175T/G/Z DF200, DF225, DF250 DF200A DF250AP, DF300AP DF350A, DF325A, DF300B	(2014+) (2012-23) (2020-21) (2019-25) (2017+) (2019-23) (2014-16) (2024+) (2015-23) (2020-23) (2020+)	
5 REC34840-87L01	34840-87L00/01	DF60A DF70A, DF90A	(2010-14) (2010-11)	
6 REC34801-93J03	34801-93J00/1/2/3	DF200 DF225	(2010-14) (2010-23)	



TRIM PLUGS EXTRACTOR		EXTRACTOR TAPONES DE TRIM	ESTRATTORE PER TAPPI DI TRIM	EXTRACTEUR DE BOUCHON DE TRIM
REF		(A)		
RECTOOLTRIMKIT	RECTOOLTRIM1 1/2" + RECPIN4	+ RECPIN4.5 38 mm		
	RECTOOLTRIM2 1/2" + RECPIN4	+ RECPIN4.5 32 mm		
	RECTOOLTRIM3 1/2" + RECPIN6	35 mm		
	RECTOOLTRIM4 1/2" RECPIN4.5	47mm		
SPARE KITS Replacement pins are not guaranteed. KITS DE RECAMBIO	Los pines de repuesto no tienen garantía. KIT DE RICAMBIO	I pini di ricambio non sono garantiti. KITS DE RECHANGE Les broches de	remplacement ne sont pas garanties.	



REF		
RECPIN4	3 x 4 mm	RECTOOLTRIM1 RECTOOLTRIM2 RECTOOLTRIM1
RECPIN4.5	3 x 4.5 mm	RECTOOLTRIM2 RECTOOLTRIM4
RECPIN5	3 x 5 mm	RECTOOLTRIM8 RECTOOLTRIM3
RECPIN6	3 x 6 mm	RECTOOLTRIM5 RECTOOLTRIM6 RECTOOLTRIM7





# Steering System

STEERING SYSTEM

SISTEMA DE GOBIERNO

SISTEMA DI GUIDA

SYSTÈME DE DIRECTION

1

ENGINE CONTROLS

MANDOS DE CONTROL

COMANDI DI CONTROLLO

BOITIER DE COMMANDE

TOP MOUNT	MANDO PARA CONSOLA	COMANDO PER CONSOLLA	BOITIER POUR CONSOL
REF	OEM	TRIM SWITCH	TRIM SWITCH HORIZ. 
1 REC67200-88L00	67200-88L00 67200-93J12/13	A REC37850-93J10	DF70A-250
2 REC67200-88L10	67200-88L10 67200-93J15	B REC37220-92E00	



SIDE MOUNT	MANDO LATERAL	COMANDO LATERALE	BOITIER LATERAL
------------	---------------	------------------	-----------------

REF	OEM		TRIM SWITCH
1 REC67200-94J20	67200-94J20 67200-91J00/01/04	DF8A, DF9.9A DF9.9, DF15 DF25, DF30 DF25A, DF30A DF25V-TWIN	(2010+)
			(2005-10) (2005-08)
REC67200-99E56	67200-99E10/30-0EP 67200-99E50/51/56	DF25, DF30 DF40, DF50 DF60, DF70 DF25A, DF30A DF40, DF50	(W+W/O PT) (2000-04)
			(1999-04) (1998-04)
2 REC67200-93J51	67200-93J50/51 67200-93J00/1/2/3/4/6	DF60Q, DF70 DF70A, DF90A DF90, DF115, DF140 DF150, DF175, DF200A DF200, DF225, DF250	(2014+)
			(2005-10) (2010+) (2005-10)



REC37850-90J06

SINGLE CONTROL	MANDO INDIVIDUAL	COMANDO	BOITIER
----------------	------------------	---------	---------

REF	OEM	
REC67200-93J30	67200-93J30	DF8A - 250 HP



# 2

## COMPONENTS

### CABLE CONNECTOR

REF	OEM		A (mm)
1 REC663-48344-00		6>115HP	37
2 PAF25-07000007W	67275-95600	6>115HP	14.5
3 PAF115-08000002			38
4 PAF40-05000016W			63

## COMPONENTES

### CONECTORES DE CABLES

## COMPONENTI

### CAVO CONNETTORE



## COMPOSANT

### EMBOUT DE CABLE



### BLOCK CONTROL HANDLE

### PLACA CERRADURA SELECTOR

### PLACCA SERRATURA SELETORE

### CALE POIGNEE DE CONTRÔLE

REF OEM

PAF15-13010010W 67256-95600



### CLIP

### CLIP

### CLIP

### CLIP

REF OEM

PAGB/T896-6 57292-94300



# 3

## STEERING

## DIRECCIÓN

## COMANDO



## COMMANDE

### THROTTLE CABLE

### CABLE DE ACELERADOR

### CAVO ACCELERATORE

### CÂBLE D'ACCELERATEUR

REF	OEM		
REC63610-89E01	63610-89E01-000	DT15C (1989-97)	
REC63610-93501	63610-93501-000	DT9.9 - 16 (1982-92)	
1 REC63610-96321-000	63610-96321-000	DT9.9K, DT15K-G-Y (1986-00)	560 mm
REC63610-96302	63610-96302-000	DT9.9, DT15K1-K4 (2001-04)	
REC63610-94402	63610-94402-000	D20, DT25, DTG-Y (1986-00)	490 mm
REC63610-91J20	63610-91J20 (2002-15)	DT40C-W-G-X (1986-99)	
2 REC63610-91J20	63610-91J00/1/3/4	DF4, DF5, DF6 (2002-15)	









### CONTROL CABLES

### CABLES DE CONTROL

### CAVI COMANDO

### CÂBLES DE COMMANDE

REF	RO			
PRE3300C05		5' / 1,50 m		
PRE3300C06		6' / 1,80 m		
PRE3300C07		7' / 2,10 m		
PRE3300C08	99105-11002-008	8' / 2,45 m		
PRE3300C09	99105-11002-009	9' / 2,75 m		
PRE3300C10	99105-11002-010	10' / 3,05 m		
PRE3300C11	99105-11002-011	11' / 3,35 m	10-32"	3"
PRE3300C12	99105-11002-012	12' / 3,65 m		76 mm
PRE3300C13	99105-11002-013	13' / 3,95 m		
PRE3300C14	99105-11002-014	14' / 4,25 m		
PRE3300C15	99105-11002-015	15' / 4,60 m		
PRE3300C16	99105-11002-016	16' / 4,90 m		
PRE3300C17	99105-11002-017	17' / 5,20 m		

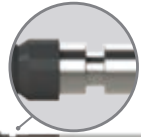

REF	RO			
PRE3300C18	99105-11002-018	18' / 5,50 m		
PRE3300C19	99105-11002-019	19' / 5,80 m		
PRE3300C20	99105-11002-020	20' / 6,10 m		
PRE3300C21	99105-11002-021	21' / 6,40 m		
PRE3300C22	99105-11002-022	22' / 6,70 m		
PRE3300C23	99105-11002-023	23' / 7,00 m		
PRE3300C24	99105-11002-024	24' / 7,30 m	10-32"	3"
PRE3300C25	99105-11002-025	25' / 7,60 m		76 mm
PRE3300C26	99105-11002-026	26' / 7,90 m		
PRE3300C27	99105-11002-027	27' / 8,25 m		
PRE3300C28	99105-11002-028	28' / 8,55 m		
PRE3300C29	99105-11002-029	29' / 8,85 m		
PRE3300C30	99105-11002-030	30' / 9,15 m		



IGNITION STARTER  
SWITCH

## LLAVES DE ARRANQUE

## CHIAVI DI ACCENSIONE CONTACTEUR A CLÉ

	REF	OEM		
1	REC37110-99E00	37110-99E00		2-4
2	REC37110-93J11	37110-93J10/11	DF9.9 - DF250	4



## SWITCH PANEL

## INTERRUPTOR PANEL

## INTERRUTTORE PANNELLO

## TABLEAU DE COMMANDE

	REF	OEM	STATIONS
1	REC37100-96J25	37100-96J20/21/22/23/24/25	1
2	REC37100-96J15	37100-96J14/15	2

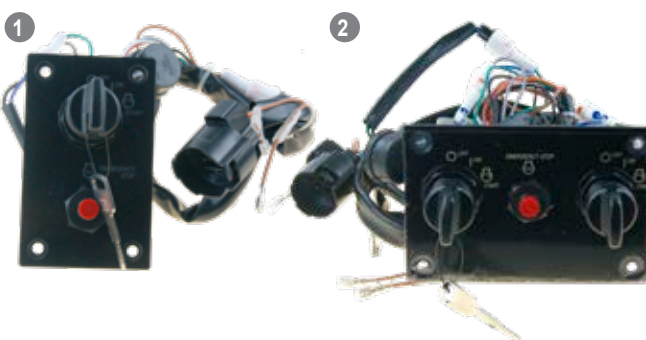

## CUT OFF SWITCHES

DESCONECTORES DE  
SEGURIDADCHIAVETTA DI  
SICUREZZACOUPE CIRCUIT DE  
SECURITE

## CUT OFF SWITCHES

## DESCONECTORES DE SEGURIDAD

## CHIAVETTA DI SICUREZZA

## COUPE CIRCUIT DE SECURITE

	REF	OEM		
1	REC37800-93954	37800-93953/4	DT2, DT2.2G-Y DT20, DT25, DT30G-Y DT25, DT30K1-K2 DT40G-X-W-C DT9.9, DT15K1-K5 DT9.9K, DT15K-G-Y	(1986-00) (1986-00) (2001-02) (1986-99) (2001-04) (1986-00)
2	REC37830-89E03	37830-95000 37830-89E02	DT4, J4, DT5Y DT5Y DT5, DT6, DT8Y-G DT6, DT8Y-K2 DT8, DT9.9C-J-V DT9.9K, DT15K-G-Y DT9.9, DT15K1-K4 DT15C	(1988-97) (1998-02) (1986-00) (2000-02) (1988-97) (1986-00) (1989-97) (1988-00)
3	REC37820-92E03	37820-92E00	DT75, DT85Y-J DT4, DT140HP	(1988-00)
4	REC37830-95D04	37830-95D00/1/2/3/4	DF9.9, DF140 HP V6H-Y	4--->30HP
5	REC37830-91J04	37830-91J04	DF4, DF5, DF6	(2002-11)
6	REC37820-93J05	37820-93J05	DF8 - DF300 DF60, DF70 DF25, DF30	W-K9 (1998-09) Y K6 (2000-06)



# 6

## HARNESS

ARNES EXTENSION  
ANALOGIC SYSTEM

REF	OEM		TRIM
1 REC36620-93J12	36620-93J12	2 m	✓
2 REC36620-93J02	36620-93J02	5 m	✓
3 REC36620-94J01	36620-94J01	5 m	
4 REC36620-93J62	36620-93J62	8 m	✓



## ARNÉS

EXTENSIÓN DE ARNÉS SISTEMAS  
ANALÓGICOS

## CAVI

ESTENSIONE  
SISTEMA ANALOGICO

## FAISCEAU ELECTRIQUE

RALLONGE FAISCEAU  
SISTÈME ANALOGIQUE

ARNES EXTENSION  
DIGITAL SYSTEM

REF	OEM		SPEC
1 REC36620-98J33	36620-98J33	6,5 m	1.0
2 REC36620-98L00	36620-98L00	6,5 m	2.0

ESTENSIONE  
SISTEMA DIGITALE

RALLONGE FAISCEAU  
SISTÈME DIGITAL



# 7

## SILENBLOCK

SILENBLOCK

REF	OEM		
1 REC54130-96320	54130-96310/20	DT20/DT25/DT30 DT25/DT30	G-Y (1986-00) K1-K2 (2001-02)
2 REC54160-94410	54160-94410	DT40 DT40W	C-W G-X (1986-99) K1-K4 (2001-04)

## SILENBLOCK

SILENBLOCK

## SILENBLOCK





SILENBLOCK



## SILENBLOCK

SILENBLOCK



BRACKET		BRACKET		BRACKET		BRACKET	
BOLT, CLAMP BRACKET		SOPORTE BARRA DE DIRECCIÓN		SUPPORTO BARRA DIREZIONE		TUBE SUPPORT CABLE DE DIRECTION	
REF	OEM						
PAF15-01010007	09159-22003/4/6						
PIN		PIN CIERRE TAPAS PROTECTORAS		CHIAVISTELLO		GOUPILLE	
REF	OEM						
REC61616-93ELO	61616-93ELO 61616-93E00	DF8 - DF70					
HOOD LATCH		CIERRE CAPOTA		CHIUSURA DEL TETTO		FERMETURE DE CAPOTE	
REF	OEM						
REC61610-90L00	61610-90L00 61610-93900/1 61610-93E01	DF8A/AR, DF9.9A/AR (2010+) DF9.9/DF15(R) (2004-12) DF9.9, DF15 T-K3 (1996-03) DT9.9, DT15 K1-K4 G-Y (1986-04) DF9.9B, DF15A, DF20A (2013+) DT20, DT25, DT30 G-Y (1986-02) DF25A, DF30A (2015+) DT40W K1-K4 (2001-04) DT40C-W G-X (1986-99) DF40, DF50 X-K10 (1999-10) DF60, DF70 W-K9 (1998-09)					
PLUG		TAPON EJE DE MOTOR DIRECCION		TAPPO		BOUCHON	
REF	OEM						
REC41151-94500	41151-94500	25 - 350					
WING NUT		PALOMILLA FIJACION MOTOR		DADO FARFALLA		ECROU PAPILLON	
REF	OEM						
REC41212-93001-OEP	41212-93001-OEP/OED 41212-93900-OED	DT9.9K, DT15K G-Y (1986-00) DT15C (1989-97) DT20, DT25, DT30 K1-K2 G-Y (1986-02) DF25, DF30 Y-K6 (2000-06) DT40W K1-K4 (2001-04)					
BUSH, SWIVEL		CASQUILLO BASCULANTE		TAPPO GIREVOLE		BAGUE	
REF	OEM						
1 REC43211-87JL0	43211-87JL0 43211-94401	DF8 (2010+) DF9.9, DF15 (2004+) DF20 (2011+)					
2 REC43711-97E11	43711-97E00/11	DT40 --> DT225 HP DF40 --> DF300 HP					
3 REC43211-94401	43211-94401	DF9.9 (2006-10) DF15 (2004-10) DT15 (1989-97) DF25, DF30 (2000-07) DT35 (1986-89) DT40 (1986-98) DF40, DF50 (1999-10)					



# Cooling System

COOLING SYSTEM

SISTEMA DE REFRIGERACIÓN

SISTEMA DI RAFFREDDAMENTO

SYSTÈME DE REFRROIDISSEMENT

















1

THERMOSTAT

TERMOSTATO

TERMOSTATO

THERMOSTAT

THERMOSTAT	TERMOSTATO		TERMOSTATO	THERMOSTAT		
REF	OEM	°C				
1 REC67F-12411-01	17670-93J00	60°	DF70A, DF80A, DF90A DF100B DF90, DF100, DF115 DF140 DF115WT, DF140WTK-3 DF150T/Z, DF175T/Z DF200, DF225, DF250 DF300T/Z	(2009+) (2018+) (2001-11) (2002-12) (2003) (2006-11) (2004+) (2007-11)		
2 REC17670-87J00	17670-87J00	72°	DF40, DF50X-K10 DF60, DF70W-K9 DF100A, DF115A, DF140A DF140	(1999-10) (1998-09) (2013+) (2002-12)		
3 REC17670-90J10	17670-90J10	71°	DF150, DF175 DF200, DF250, DF225 DF300 DF70, DF80, DF90 (A) DF100B DF90, DF100, DF115 DF100, DF115, DF140	(2006+) (2004+) (2019+) (2009+) (2018+) (2001-11) (2013+) (2018+)		
4 REC60V-12411-00	17670-90J20	50°	DF150, DF175 DF200A/AP/AT DF250AP, DF300AP	(2012+) (2015+) (2012+)		
5 REC17670-91J01	17670-91J00/1	50°	DF2.5 DF4, DF5, DF6 DF9.9B, DF15A, DF20A	(2006) (2002+) (2013+)		
6 REC17670-93962	17670-93962	50°	DF40, DF50X-K10 DF60, DF70W-K9 DT20, DT25, DT30G-Y DT25, DT30 K1-K2 DT40C-W G-X DT40WK1-K4 DT55, DT65J-X DT9.9, DT15K1-K4 DT9.9K, DT15K G-Y	(1999-10) (1998-09) (198600) (2001-02) (1986-99) (2001-04) (1988-99) (2001-04) (1986-00)		
7 REC17670-94402	17670-94402	60°	DF25, DF30Y-K6 DF640, DF50X-K10 DF60, DF70W-K9 DF9.9, DF15 DT20, DT25, DT30G-Y DT25, DT30K1-K2 DT40C-W G-X DT40W K1-K4 DT9.9, DT15	(2000-06) (1999-10) (1998-09) (1996-11) (1986-00) (2001-02) (1986-99) (2001-04) (1986-04)		
8 REC17670-94J01	17670-94J00/1	60°	DF8A, DF9.9A (AR) DF9.9, DF15 (R) DF20R, DF25R/Q, V2 DF25A, DF30A	(2010+) (2004-12) (2006-13) (2015+)		

WATER FLUSH PLUG	TAPÓN DE AGUA	TAPPO ACQUA	BOUCHON DE REFRROIDISSEMENT
------------------	---------------	-------------	-----------------------------

REF	OEM	
1 REC17913-93J00	17913-93J00	DF8 --> DF350
2 REC17914-93J00	17914-93J00/LO	



GASKET	JUNTA	GUARNIZIONE	JOINT
--------	-------	-------------	-------

REF	OEM			
1 REC17685-94410	17685-94410	DT40C-W, G-X, W DT55, DT65 DF40, DF50	K1-K4 J-X X-K10	(986-04) (1988-99) (1999-10)
2 REC17685-87D10	17685-87D00/10	DT90, DT100 DT150, DT200, DT225	L-Y, V6-H-Y W-K3	(1987-00) (1998-03)

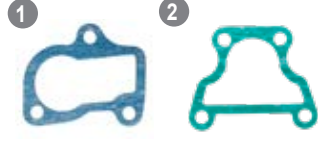

3

IMPELLER	IMPULSORES	GIRANTE	TURBINE
----------	------------	---------	---------

O-RING	O-RING TAPON DE AGUA	FASCIA TONDA	JOINT TORIQUE
--------	----------------------	--------------	---------------

REF	OEM			
REC09280-13005	09280-13005	DF25/DF30 DF25A/DF30A DF60/DF70 DF90/DF100/DF115 DF100A/DF115A/DF140A DF115/DF140 DF140 DT20/DT25/DT30 DT55/DT65 DT75/DT85	Y-K6 W-K9 WT K3 J-X J-Y	(2000-06) (2015+) (1998-09) (2001-11) (2013-19) (2003) (2002-12) (1986-02) (1988-99) (1988-00)



WATER PRESSURE VALVE	VALVULA CONTROL PRESION AGUA	VALVOLA DI PRESSIONE DELL'ACQUA	VANNE DE PRESSION D'EAU
----------------------	------------------------------	---------------------------------	-------------------------

REF	OEM		
1 REC17660-90J00	17660-90J00	DF90/DF100/DF115 DF100A/DF115A/DF140A DF140 DF150/DF175/DF200 DF150A/DF175A/DF200A DF150AP/DF175AP/DF200AP DF200A/DF200AP/DF200AT/DF200AZ	AT/AZ
2 REC17660-99E01	17660-99E00/1	DF200/DF225/DF250 DF25/DF25R/DF25Q V2 DF250AP/DF300AP DF300T/Z DF40/DF50 DF40A/DF50A/DF60A DF70A/DF75A/DF80A/DF90A/DF100B	X-K10



WATER HOSE SEAL	RETÉN DE TUBO DE AGUA	GOMMA TUBO ACQUA	BAGUE DE TUBE D'EAU
-----------------	-----------------------	------------------	---------------------

REF	OEM			
1 REC17566-94400	17566-94400/1	DF40 - DF50	X-K10	(1999-10)
2 REC17563-94400	17563-94400	DT40	C-W G-X	(1986-99)
3 REC17565-94400	17565-94400	DT40	W K1-K4	(2001-04)
4 REC17564-93J01	17564-93J01	DF150-DF350		(2006+)



IMPELLER GUIDE	GUÍA DE IMPULSORES	GUIDA GIRANTE	GUIDE TURBINES
----------------	--------------------	---------------	----------------

H4		REF	HIGH PERFORMANCE	CEP	A (mm)	B (mm)	C (mm)
1	DF2.5	2003+	REC17461-97JM0				
	DF4, DF6	2003+					
2	DF8	2010+	REC17461-98503	REC17461-98503-HP	17461-98503	CEF500336	10,15 41 14
	DF9, DF15	2004+				CEF500329	13,2 42 22
	DF25	1999-10					
	DF25A	2015+					
3	DF30	1999-07	REC17461-96312	REC17461-96312-HP	17461-96312 17461-94L00	CEF500362G	17,1 67,5 16,18
	DF30A	2015+					
	DF40, DF50	1999+					
	DF60	1998-09					
4	DF70	1998+	REC17461-87E12	REC17461-87E12-HP	17461-87E10/11/12	CEF500365	22,2 78,3 26
	DF80, DF90	2010+					
	DF100	2001+					
5	DF115, DF140	2002+	REC17461-90J01	REC17461-90J01-HP	17461-90J01	CEF500367	24,3 86 31,7
	DF150	2008+					
	DF175	2007+					
6	DF200, DF225, DF250	2004+	REC17461-93J00	REC17461-93J00-HP	17461-93J00	CEF500393	24,3 87 39
	DF300	2007+					

**HIGH PERFORMANCE**

GASKETS INCLUDED  
JUNTAS INCLUIDAS  
GUARNIZIONI INCLUSE  
JOINTS INCLUS

MADE IN

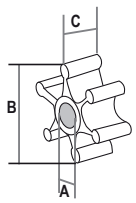

H2		REF	HIGH PERFORMANCE	OEM	CEP	A (mm)	B (mm)	C (mm)
2	DT4	1988-01						
	DT5	1986-02	REC17461-98503	REC17461-98503-HP	17461-98501/2/3	CEF500336	10,15 41 14	
	DT6	1984-02						
	DT8	1980-87						
7	DT8	1988-97	REC17461-92D02	REC17461-92D02-HP	17461-92D02	CEF500319	12,2 42 20	
8	DT9,9	1980-87	REC17461-93004		17461-93001/3/4		15 70 12,5	
7	DT9,9	1988-97	REC17461-92D02	REC17461-92D02-HP	17461-92D02	CEF500319	12,2 42 20	
8	DT14	1977-80	REC17461-93004		17461-93001/3/4		15 70 12,5	
9	DT15	1986-97	REC17461-93903	REC17461-93903-HP	17461-93901/2/3	CEF500329	13,2 42 22	
8	DT16	1977-82	REC17461-93004		17461-93001/2/3/4		15 70 12,5	
3	DT20	1986-88	REC17461-96312	REC17461-96312-HP	17461-96301	CEF500362G	17,1 67,5 16,18	
8	DT25	1977-82	REC17461-93004		17461-93001/2/3/4		15 70 12,5	
3	DT25	1983-88	REC17461-96312	REC17461-96312-HP	17461-96301	CEF500362G	17,1 67,5 16,18	
10	DT25	1989-00			17461-96400	CEF500399	17,2 67 16,16	
8	DT28	1972-82	REC17461-93004		17461-93002		15 70 12,5	
3	DT30	1983-85	REC17461-96312	REC17461-96312-HP	17461-96301	CEF500362G	17,1 67,5 16,18	
10	DT30	1989-00			17461-96400	CEF500399	17,2 67 16,16	
3	DT35	1987-89	REC17461-96312	REC17461-96312-HP	17461-96301	CEF500362G	17,1 67,5 16,18	
11	DT40	1983	REC17461-94700	REC17461-94700-HP	17461-95201	CEF500312	19,13 51,8 19	
3	DT40	1984-98	REC17461-96312	REC17461-96312-HP	17461-96310	CEF500362G	17,1 67,5 16,18	
12	DT50	1978-84	REC17461-95300		17461-95501 17461-95300	CEF500360	20,1 67,5 19	
11	DT55	1985-97	REC17461-94700	REC17461-94700-HP	17461-94700/1 17461-95200	CEF500361	17,1 67 19	
	DT60	1983						
12	DT60	1984	REC17461-96312		17451-96301	CEF500362G	17,1 67,5 16,18	
11	DT65	1985-97	REC17461-94700	REC17461-94700-HP	17461-94701	CEF500361	17,1 67 19	
12	DT75	1983-97	REC17461-95300		17461-95501 17461-95300/1/2	CEF500360	20,1 67,5 19	
	DT85	1983-00						
4	DT90, DT100	1988+	REC17461-87E12	REC17461-87E12-HP	17461-87E12	CEF500365	22,2 78,3 35,1	
5	DT115, DT140	1986-01	REC17461-90J01	REC17461-90J01-HP	17461-94510 17461-90J00/1	CEF500367	24,3 86 31,7	
	DT150	1987-96						
	DT200, DT225	1998-03						



KEY		CHAVETA	CHIAVETTA	CLAVETTE		
REF	OEM					
1	REC09420-03002	09420-03002	DF4, DF5, DF6 DT4/J4, DT5Y DT4K1 DT5, DT6, DT8G-Y DT5Y DT6, DT8Y-K2	(2006+) (1988-00) (2001) (1986-00) (1998-02) (2000-02)	REC17461-98503	
2	REC17462-93990	17462-93990	DF9.9, DF15 DT9.9 DT15	(2004-10) (1983-87) (1983-97)		
3	REC09420-03005	09420-03005/0	DF8Z, DF9.9A (AR) DF9.9, DF15 (R) DF9.9B, DF15A, DF20A DF15	(2010+) (2004-11) (2013+) (2012)	REC17461-93903	
4	REC09420-04006	09420-04006	DF20R, DF25 (RVZ) DF25/R/QVZ DF25, DF30Y-K6 DF40, DF50X-K10 DF40A, DF50A, DF60A DT20, DT25, DT30G-Y DT25, DT30 DT25C, DT30C DT40C-W DT40W	(2006-11) (2013) (2000-06) (1999-10) (2010+) (1986-00) (2001-02) (1989-00) (1986-99) (2001-04)	REC17461-96312	
5	REC09420-04009	09420-04009	DF40A, DF50A, DF60A, DF90A, DF100B DT90, DT100	(2014+) L-Y (1990-00)		
6	REC09420-04005	09420-04005	DT55/DT65 DT75/DT85	J-X (1988-99) J-Y (1988-00)	<b>NEW</b>	
7	REC09420-05009	09420-05006/9	DF90, DF100, DF115 DF115WT, DF140WT V6H-Y DF100A, DF115, DF140A DF140 DF150, DF175 DF200, DF225, DF250 DF250AP, DF300AP DF350, DF300 DT115, DT140G-Y DT150, DT200, DT225W-K3	K3 (2003) (1987-00) (2013+) (2002-12) (2006+) (2004+) (2013+) (2007) (1986-00) (1989-03)		
8	REC09420-05005	09420-05005	DT115, DT140	G-Y 1986-2000	<b>NEW</b>	













IMPELLER PLATE		TAPA DEL IMPULSOR	COPERCHIO GIRANTE	PLAQUE DE POMPE À EAU			
REF	OEM						
1	REC17471-97J00	17471-97J00-00	DF2.5	(2006-11)			
2	REC17471-97JL0	17471-97JL0	DT2.5	(2012+)			
3	REC17471-98610	17471-98610	DF4, DF5, DF6	(2002+)			<b>NEW</b>
4	REC17471-98601	17471-98601 17471-98600	DT4-J4-DT5Y DT4K1 DT5Y	(1988-00) (2001) (1998-02)			
5	REC17471-93902	17471-93902	DF9.9(R)T-K3 DF15(R)-K3 DT15C DT9.9, DT15K1-K4 DT9.9K, DT15K-G-K4 DT9.9K, DT15K-G-Y	(1996-11) (1996-12) (1989-97) (2001-04) (2001-04) (1986-00)			
6	REC17471-95J01	17471-95J00/01	DF20R, DF25, DF25R/Q (V2) DF40A, DF50A, DF60A	(2006-13) (2010+)			
7	REC17471-94401	17471-94401	DF25, DF30Y-K6 DF40, DF50X-K10 DF20, DF25, DF30G-Y DF25C, DT30C-K-Y DT40C-W-G-X DT25, DT30 K1-K2 DT40W - K1-K4	(2000-06) (1999-10) (1986-00) (1989-00) (1986-99) (2001-02) (2001-04)		<b>NEW</b>	
8	REC17471-87L01	17471-87L01	DF70A, DF80A, DF90A, DF100B	(2009+)			
9	REC17471-92J00	17471-92J00 17471-87E00/01	DT90, DT100L-Y DF60, DF70W-K9 DF90, DF100, DF115 DF140	(1990-00) (1998-09) (2001-11) (2002-12)		<b>NEW</b>	
10	REC17471-92J02	17471-92J00/1/2	DF100A, DF115A, DF140A DF150, DF175 (T/Z) DF200, DF225, DF250 DF150AP, DF175AP, DF200AP DF150AT, DF175AT, DF200AT DF200A/AP DF200AT/AZ	(2013+) (2006+) (2004+) (2017+) (2019) (2015-17) (2018)		<b>NEW</b>	
11	REC17471-87D01	17471-87D00/01	DT150, DT200, DT225 W-K3 V6 H-Y	(1998-03) (1987-00)			
12	REC17471-98L00	17471-98L00	DF350A, DDF325A DF300B	(2018+) (2020+)		<b>NEW</b>	

## WATER PUMP

## BOMBA DE AGUA

## POMPA ACQUA

## POMPE À EAU

HOUSING, WATER PUMP		CUERPO BOMBA DE AGUA		CORPO, POMPA ACQUA		CORPS DE POMPE À EAU	
REF	OEM						
1 REC17411-93901	17411-93901/10	DT9.9, DT15 DT9.9K, DT15K-G-Y DT15C DF9.9, DF15 (R) DF9.9, DF15T-K3	K1-K4	(2001-04) (1986-00) (1989-97) (2004-11) (1996-03)	SUZUKI P. 93		
2 REC17450-93921	17450-93920/21/30 17450-93440	DT9.9K, DT15K G-Y		(1986-00)	SUZUKI P. 93		
3 REC17411-94J00	17411-94J00	DF9.9 - DF15 DF15 DF15A, DF20A	(R)	(2004-12) (2010-12) (2013-23)	SUZUKI P. 95		
4 REC17411-94421	17411-94421/31	DT20, DT25, DT30 DT25, DT30 DF25, FG30 DT40C-W-G-X DT40W DF40, DF50X-K10 DF50	G-Y K1-K2 Y-K6 K1-K4	(1986-00) (2001-02) (2000-06) (1986-99) (2001-04) (1999-10) (2010)	SUZUKI P. 99	SUZUKI P. 101	
5 REC17410-95J00	17410-95J00	DF25/R/Q V2		(2010-23)			
6 REC17411-94L00	17411-94L00	DF25A/DF30A		(2015+)			
7 REC17410-88L00	17410-88L00	DF40A DF50A/DF60A		(2011-23) (2010+)	SUZUKI P. 103		
8 REC17410-99E10	17410-99E10	DF70A, DF90A/DF100B DF75A		(2010-23) (2023)	SUZUKI P. 105		
9 REC17400-90812	17400-90810/11/12 17411-90J00	DF90, DF100, DF115 DF140 DF100A, DF115A, DF140A DF100C DF115B, DF140B DF115 DF140 DF140A DF140B		(2001-11) (2002-11) (2013-23) (2023) (2021+) (2011-12) (2012) (2013-21) (2022-23)			
10 REC17410-92J00	17410-92J00	DF150T/Z, DF175T/Z DF150A, DF175A, DF200A DF150 DF175 DF175A		(2006-18) (2015+) (2010-18) (2010-18) (2019-23)	SUZUKI P. 107		
11 REC17411-96J01	17411-96J01/2/3/4	DF200, DF225, DF250 DF250AP, DF300AP DF300A/B, DF325A, DF350A DF300 DF300AP DF300T/Z		(2004+) (2014+) (2018+) (2010-11) (2012-23) (2007-11)	SUZUKI P. 111		
12 REC17410-93J01	17400-93J00/01 17411-93J00				SUZUKI P. 113	SUZUKI P. 115	





## WATER PUMP, COVER

## TAPA DE LA BOMBA

## COPERCHIO POMPA

## PLAQUE DE POMPE À EAU

REF	OEM					
1 REC56130-94413-0EP	56130-94413-0EP 56130-94411-0EP	DF40, DF50X-K10 DF40W-K1-K4 DT40C-W G-X		(1999-10) (2001-04) (1986-99)		
2 REC56130-96331-0EP	56130-96331-0EP 56130-96320-0EP	DT20, DT25, DT30		(1986-02)		

**WATER PUMP SERVICE KITS**

**KITS DE REPARACIÓN BOMBA DE AGUA**

**KIT RICAMBI POMPA ACQUA**

**KIT REPARATION DE POMPE À EAU**

REF	OEM		
1 REC17400-98661	17400-98661 17400-986L0/1	DF4, DF5, DF6	(2002-15)
2 REC17400-98652	17400-98652/61	DT4 /J4, DT5Y DT4K1	(1988-02) (2001)
3 REC17400-98551	17400-98551	DT5,DT6, DT8G-Y DT6, DT8Y-K2	(1986-00) (2000-02)
4 REC17400-92D01	17400-92D01/11	DT8C, DT9.9C-J-V	(1988-97)
5 REC17400-94J00	17400-94J200	DF9.9, DF15 DF15	(2007+) (2010-12) (2010+)
6 REC17400-99J01	17400-99J00/01	DF9.9A/AR/B DF8A/AR DF15A, DF20A	(2013-23) (2001-04)
7 REC17400-93912	17400-93911/12	DT9.9, DT15K1-K4 DT9.9K, DT15KG-Y	(1986-00) (1996-03)
8 REC17400-93951	17400-93950	DF9.9, DF15T-K3 DT9.9K, DT15K-G-Y DT15C	(1986-00) (1989-97) (1986-00)
9 REC17400-96403	17400-96350/1/2/3 17400-96403	DT40C-W-G-X DT25C, DT30C-K-Y DF25, DF30 DF40, DF50	(1986-99) (1989-00) (2000-07) (1999-10)
10 REC17400-95J02	17400-95J01/2	DF25V	(2010-14)
11 REC17400-94L00	17400-94L00	DF25A, DF30A	(2015-23)

REF	OEM		
12 REC17400-88L00	17400-88L00	DF40A, DF50A DF60A	(2011-23) (2010-23)
13 REC17400-94701	17400-94700/1	DT55, DT65J-X	(1988-99)
14 REC17400-95351	17400-95550 17400-95350/1	DT75, DT85J-Y	(1988-00)
15 REC17400-87L01	17400-87L00/1	DF70A, DF90A DF75A	(2010-23) (2023)
16 REC17400-92J00	17400-92J200	DF90, DF100, DF115, DF140	(2006-08)
17 REC17400-87E04	17400-87E03	DT90, DT100L-Y DF60, DF70W-K9	(1990-00) (1998-09)
18 REC17400-90J20	17400-90J11	DF90, DF100, DF115K1-K11 DF140 DF115	(2001-11) (2002-11) (2010)
19 REC17400-92J21	17400-92J21	DF100A, DF115, DF115A DF140A, DF150AP, DF175AP DF115 DF115A, DF140A DF115B, DF140B DF140	(2009+) (2011-12) (2013-21) (2022-23) (2012)
20 REC17400-94611	17400-94611	DT115, DT140G-Y	(1986-00)
21 REC17400-87D11	17400-87D00/10/11	V6H-Y DT150, DT200, DT225W-K3	(1987-00) (1998-03)

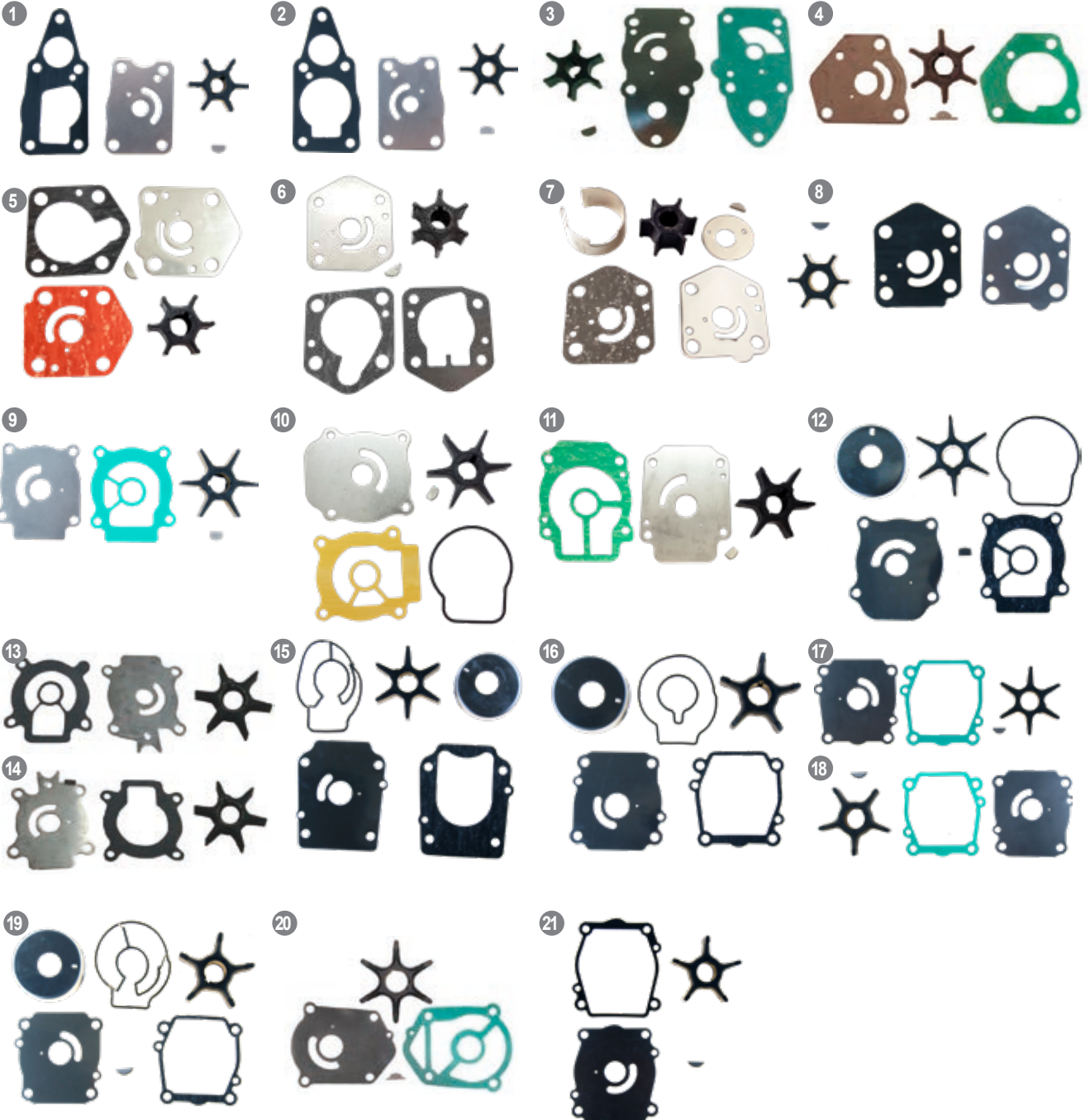

REF	OEM	
22 REC17400-96J03	17400-96J00/1/2/3	DF150/G/AP, DF170, DF175G/AP DF200A/AP (2006+) DF150, DF175 (2010-18) DF150A, DF175A (2019-23) DF200A (2015-23) DF200 (2010-14) DF225 (2010-23) DF250 (2011-23)
23 REC17400-93J01	17400-93J00/1/2/3	DF200A/AP (2006+) DF150, DF175 (2010-18) DF150A, DF175A (2019-23) DF200A (2015-23) DF200 (2010-14) DF225 (2010-23) DF250 (2011-23)



REF	OEM	
24 REC17400-98J01	17400-98J00/1/2	DF250AP (2013-23) DF300 (2010-11) DF300AP (2012-23) DF300B (2020-23) DF350A (2018-22)
25 REC17400-98L03	17400-98L03	DF250AP (2013-23) DF300 (2010-11) DF300AP (2012-23) DF300B (2020-23) DF350A (2018-22)





**GUIDE OF WATER PUMP SERVICE KITS**

**GUÍA KITS DE BOMBA DE AGUA**

**GUIDA KIT POMPA ACQUA**

**GUIDE KIT POMPE À EAU**

	REF
DT4	1984-98 REC17400-98652
DT5	1992-02
DT6	1984-02
DT8	1986-97
DT9.9	1985-87 REC17400-98551
DT15C	1989-97
DT15	1983-88
DT8	1988-97 REC17400-92D01
DT9.9C	1988-97
DT25C	1989-00
DT30C	1988-97
DT20	1985-88
DT25C	1984-88 REC17400-96403
DT30C	1984-87
DT35	1983-98
DT40C	1983-98

	REF
DT55	1985-97 REC17400-94701
DT65	1985-00
DT75	1985-00 REC17400-95351
DT85	1985-00
DT115	1986-01 REC17400-94611
DT140	1986-03 REC17400-87D11
V6	1986-03

	REF
DF4, DF6	2002+ REC17400-98661
DF9.9A	2010+ REC17400-99J01
DF9.9	2007+ REC17400-94J00
DF15	2007+
DF9.9/B	
DF15/A	1997-06 REC17400-93951
DF20A	
DF25/30	2000-07 REC17400-96403
DF40/50	1999-10 REC17400-96403
DF25A/30A	2014+ REC17400-94L00
DF60/70	1998-10 REC17400-87E04
DF40A/50A	2010+ REC17400-88L00
DF60A	
DF70A/80A	2009+ REC17400-87L01
DF90A	
DF90/100	2006-08 REC17400-92J00
DF115/140	

	REF
DF90/115	2001-05 REC17400-90J20
DF140	
DF100A	
DF115/A	
DF140A	2009+ REC17400-92J21
DF150AP	
DF175AP	
DF150/G/AP	
DF175/G	
DF175AP	2006+ REC17400-96J03
DF200A/AP	
DF200/225	2004+ REC17400-93J01
DF250	
DF250SS	
DF300A/AP	2007+ REC17400-98J01
DF25	
V-TWIN	2006+ REC17400-95J02

**WATER PUMP COVER GASKET**

**JUNTA TAPA BOMBA AGUA**

**GUARNIZIONE COPERCHIO**

**JOINT DE COUVERCLE**

REF	OEM	
1 REC11552-88L00	11552-88L00	DF40A, DF50A, DF60A (2010+)
2 REC11552-96J00	11552-96J00	DF150A, DF175A, DF200A (2015+) DF150T/G/Z, DF175T/G/Z (2006-18)
3 REC11552-87L00	11552-87L00	DF70A, DF80A, DF90A, DF100B (2009-20)



**WATER PUMP, O-RING**

**JUNTA TÓRICA BOMBA DE AGUA**

**GUARNIZIONE**

**JOINT TORIQUE DE POMPE À EAU**

REF	OEM	
1 REC17416-95J00	17416-95J00	DF20R, DF25R (VZ) (2006-13) DF40A, DF50A, DF60A (2010+)
2 REC17416-99E10	17416-99E10	DF40A, DF50A, DF60A (2014+) DF70A, DF80A, DF90A (2009+) DF100B (2018+)
3 REC17416-92J10	17416-92J10	DF90, DF100, DF115 (2001-11) DF100A, DF115A, DF140A (2013+) DF140 (2002-12)
4 REC17417-92J00	17417-92J00	DF90, DF100, DF115 (2001-11) DF140 (2002-11)
5 REC17416-93J00	17416-93J00	DF200, DF225, DF250 (2004+) DF250AP, DF300AP (2012+) DF300T/Z (2007-11) DF325A, DF350A (2018+)
6 REC17416-96J00	17416-96J00	DF150AP, DF175AP, DF200AP (2017+) DF150AT, DF175AT, DF200AT (2019) DF150T, DF175T (G)/Z (2006-18) DF200A, DF200AP (2015-17) DF200AT/AZ (2018)





**UPPER OIL SEAL**

**RETEN SUPERIOR CUERPO BOMBA**

**PARAOILIO SUPERIORE POMPA**

**JOINT D'HUILE**

REF	OEM	
REC09282-17007	09282-17007	DF40/DF50 (1999-10) DT25C/DT30C (1989-00)



WATER PUMP GASKET

JUNTAS BOMBA

GUARNIZIONE POMPA

JOINTS POMPE

REF	OEM					
1 REC17472-97JL0	17472-97JL0	DF2.5	(2012+)			
2 REC17472-97J00	17472-97J00	DF2.5	(2006-11)			
3 REC17472-91J00	17472-91J00	DF4, DF5, DF6	(2002-14)	SUZUKI	P. 89	
4 REC17472-98611	17472-98611	DT4/J4, DT5Y DT4K1 DT5Y	(1988-00) (2001) (1998-02)			
5 REC17472-98503	17472-98503	DT5, DF6, DT8G-Y DT6, DT8Y-K2	(1986-00) (2000-02)			
6 REC17472-92D10	17472-92D10	DT8C, DT9.9C-J-V	(1988-97)			
7 REC17452-93910	17452-93910	DF9.9, DF15T-K3 DT9.9K, DT15K-G-Y DT9.9, DT15 K1-K4 DT15C	(1996-03) (1986-00) (2001-04) (1989-97)	SUZUKI	P. 93	
8 REC17472-93911	17472-93911	DF9.9, DF15T-K3 DT9.9K, DT15K-G-Y DT9.9, DT15K1-K4 DT15C	(1996-03) (1986-00) (2001-04) (1989-97)	SUZUKI	P. 93	
9 REC17472-96303	17472-96301/2/3	DT20, DT25, DT30 DF25, DF30 DF20R, DF25R (VZ) DF40, DF50 DF40A, DF50A, DF60A	(1986-04) (2000-06) (2006-13) (1999-10) (2010+)	SUZUKI	P. 97 SUZUKI P. 99	SUZUKI P. 101 SUZUKI P. 103
10 REC56132-95J00	56132-95J00	DF20R, DF25/R/Q	V2 (2006-13)	SUZUKI	P. 97	
11 REC55122-94400	55122-88L00	DF40, DF50X-K10 DF40A, DF50A, DF60A DF40A, DF50A, DF60A	(1999-10) (2010+) (2014+)	SUZUKI	P. 103	
12 REC17472-87E10	17472-87E10	DF90, DF100, DF115 DF100A, AF115A, DF140A, DF100C DF140	(2001-11) (2013+) (2002+)			
13 REC17472-95310	17472-95310	DT55, DT65J-X	(1988-99)			
14 REC17472-87L00	17472-87L00	DF70A, DF80A, DF90A DF100B	(2009+) (2018+)	SUZUKI	P. 60	SUZUKI P. 105
15 REC17472-93J00	17472-93J00	DF150, DF175T-Z (G) DF200, DF225, DF250 DF200A	(2006-14) (2004+) (2015)	SUZUKI	P. 111	
16 REC17472-87D10	17472-87D00/10	DT150, DT200, DT225 V6	W-K3 (1998-03) H-Y (1987-00)			
17 REC17472-98J00	17472-98J00	DF250AP, DF300AP DF300T/Z	(2012+) (2007-11)	SUZUKI	P. 113	
18 REC17472-98L00	17472-98L00	DF300B, DF325A, DF350A	(2018+)	SUZUKI	P. 115	

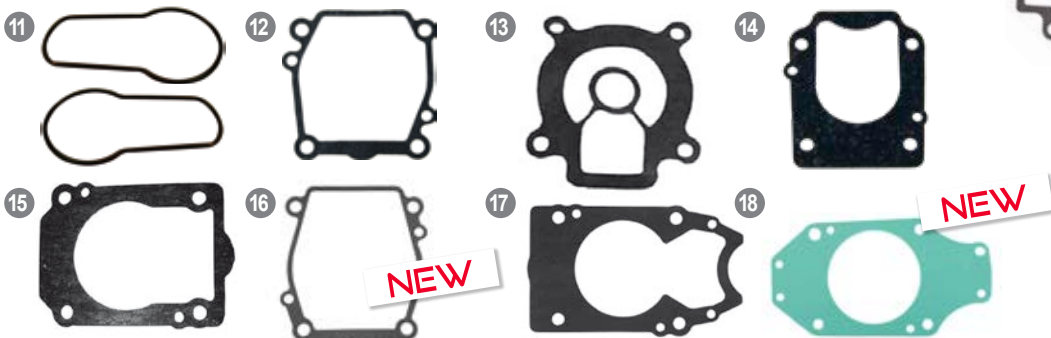
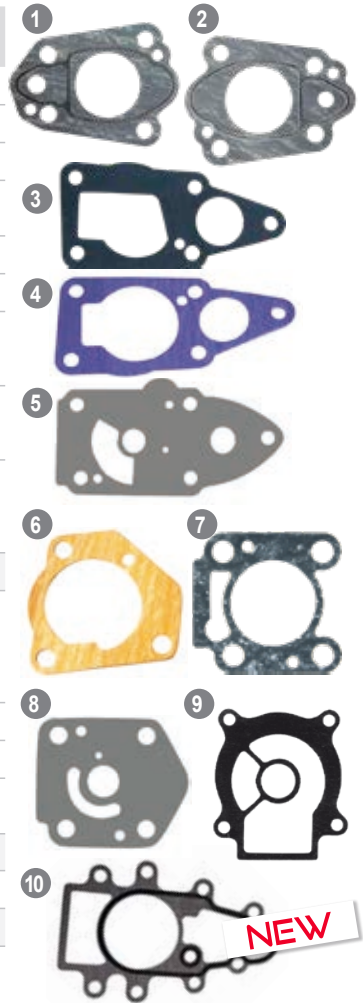

INSERT CUP

CASQUILLO INOX

GHIERA INOX

INSERT INOX

REF	OEM		
1 REC17413-97J00	17413-97J00	DF2.5	
2 REC17413-94J00	17413-94J00	DF8A/AR, DF9.9A/AR DF9.9, DF15(R) DF9.9B, DF15A, DF20A	(2010-19) (2004-12) (2013+)
3 REC17413-94L00	17413-94L00	DF15 DF15A, DF20A DF25A, DF30A	(2010-12) (2013-23) (2015-23)
4 REC17413-95J00	17413-95J00	DF40A, DF50A, DF60A DF20R, DF25, RVZ DF20, DF25R, DF25QVZ DF25V	(2010-23) (2006-11) (2013) (2010-14)
5 REC17413-99E11	17413-99E11	DF40A, DF50A, DF60A DF70A, DF80A, DF90A DF75A DF100B	(2014+) (2010-23) (2023) (2018+)

REF	OEM		
6 REC17413-92J01	17413-92J00/1	DF100A, DF115A, DF140A DF140 DF90, DF100, DF115 DF115 DF115A, DF140A DF150, DF175 DF150A, DF175A DF200A DF200 DF225, DF250 DF250AP DF300 DF300AP DF300B DDF350A	(2013+) (2012) (2001-11) (2011-12) (2013-23) (2010-18) (2019-23) (2015-23) (2010-14) (2010-23) (2013-23) (2010-11) (2012-23) (2020-23) (2018-23)
7 REC17413-96J01	17413-96J00/1	DF200, DF225, DF250 DF250AP, DF300AP DF300T/Z DF300B, DF325A, DF350A	(2004+) (2013+) (2007-11) (2018+)
8 REC17413-93J02	17413-93J00/1/2		





# Anodes

ANODES

ÁNODOS

ANODI

ANODES

1

**RECMAR®**

RECMAR ANODE

ÁNODO RECMAR

ANODI RECMAR

ANODE RECMAR

RECMAR ANODE  
GUIDE

ÁNODOS RECMAR  
GUÍA

ANODI RECMAR  
GUIDE



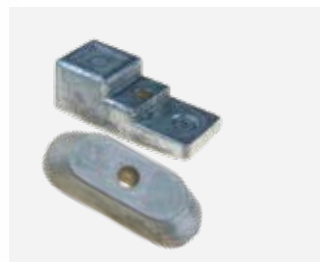
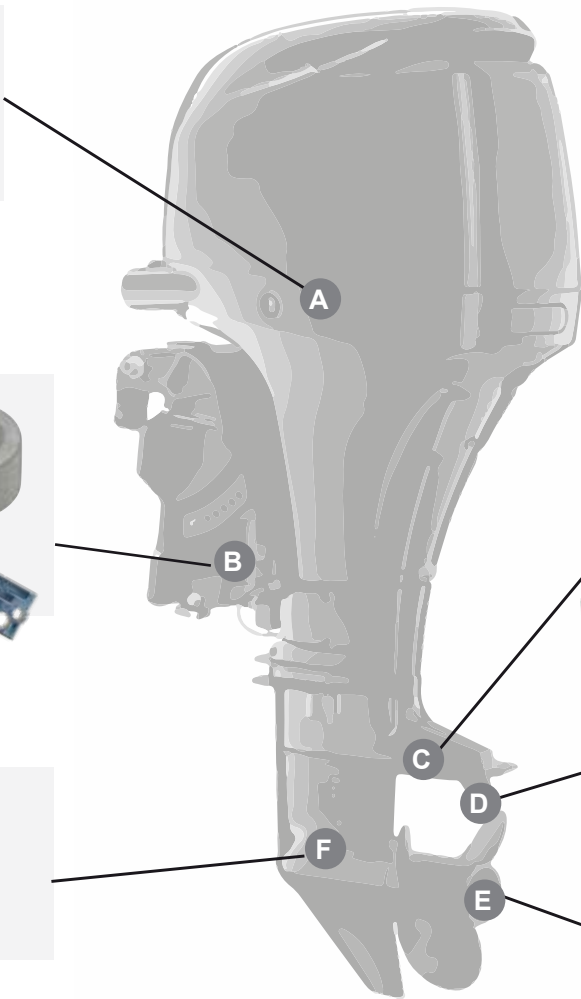
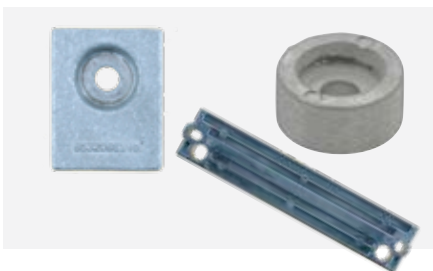











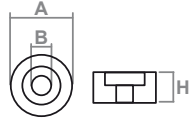



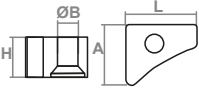



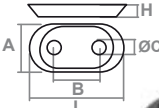



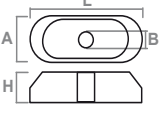



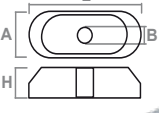

ANODES RECMAR  
GUIDA

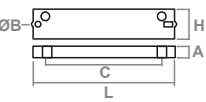



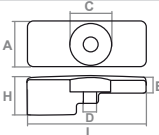









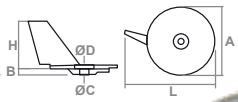

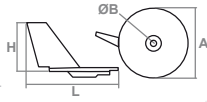
		POWER HEAD UN.	A UN.	E UN.	B UN.	F UN.	D UN.	TRIM UN.	RECTIFIER UN.	CARTER UN.
DF2.5	2010-25	REC55321-95J00	1			REC55321-87J01	1			
DF4/5/6	2010-16				REC55321-87J01	1	REC55321-87J01	1		
DF4A/5A/6A	2017-25	REC55321-95J00	1			REC55321-87J01	1			
DF8A/AR DF9.9A/AR	2010-24	REC55321-87J01	1			REC55321-87J01	1	REC55300-95500	1	
DF9.9B DF15A/20A	2014-25	REC55321-87J01	1		REC55321-87J01	2	REC55321-87J01	1		
DF9.9/15	2010-13	REC6BL-11325-00	1		REC55321-87J01	1	REC55321-90L00	1	REC55321-939L0	1
DF20R DF25R V2	2010-14	REC55321-95J00	2	REC55321-87J01	1	REC55321-87J01	1	REC55321-87J01	1	REC55125-91L01
DF25A/30A	2015-25							REC55321-87J01	1	
								REC55300-95500	1	
DF40A/50A/60A	2010-25	REC55321-87J01	2		REC55321-87J01	2	REC55300-95500	1	REC55125-95500	1
								REC55321-87J01	1	
								REC55320-95311	2	
DF70A/75A/ DF80A/90A DF100B	2010-25	REC55321-87J01	2	REC55321-87J01	1	REC55320-94900	1	REC55321-87J01	1	REC55125-90J01
								REC55321-87J01	1	
DF90/100 DF115 DF140 DF100C/A DF115A/B DF140A/B DF150/A DF175/A DF200/A	2010-12	REC55321-87J01	2		REC55320-94900	1	REC55321-90J01	1	REC55125-90J01	1
									REC55321-87J01	2
	2013-25	REC55321-87J01	2	REC55321-87J01	1	REC55321-87J01	1	REC55320-94900	1	REC55321-90J01
									REC55125-90J01	1
									REC55321-87J01	1
	2010-25	REC55321-87J01	3	REC55321-87J01	1	REC55321-87J01	1	REC55320-94900	1	REC55320-95311
									2	REC55125-90J01
										1
DF200 DF225 DF250 (V6)	2010-25	REC55321-87J01	4	REC55321-87J01	2	REC55320-95311	1	REC55320-95311	2	REC55125-90J01
										1
										REC55321-87J01
DF300/A	2010-25	REC55321-87J01	4	REC55321-87J01	2	REC55320-95311	1	REC55320-95311	2	REC55125-90J01
										1
										REC55321-87J01
DF300B DF325A	2018-25	REC55321-87J01	4	REC55321-87J01	2	REC55320-95311	1	REC55320-95311	2	REC55125-90J01
										1
										REC55321-87J01
										1

REC888-8888-00 = ZN  
REC888-8888-00AL = AL

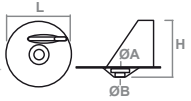
REF	OEM		KG (kg)	KG (lbs)	L	H	A	B	C	D	
REC55321-95J00	55321-95J00	DF2.5 DF4A/5A/6A	(2010-25) (2017-25)	0,01 0,02	mm	13,5	13	5			
REC55321-95J00AL	55321-95J00	DF20R, DF25R V2	(2010-14)	0,06 0,01	inch	0,53	0,51	0,20			
REC6BL-11325-00	55321-99E00	DF9.9, DF15	(2010-13)	0,02 0,04	mm	25	13	6			
REC6BL-11325-00AL	55321-99E00			0,01 0,01	inch	0,99	0,51	0,24			
REC6E5-45251-00	41810-87D00	DT90-DT225	(1987-03)	0,15 0,33	mm	48	24	23	6,50	23	
REC6E5-45251-00AL	41810-87D00			0,06 0,13	inch	1,89	0,94	0,91	0,26	0,91	
REC55320-95311	55320-95311	DF40A/50A/60A DF150/A, DF175/A, DF200/A	(2010-25) (2010-25)	0,08 0,18	mm	40	12	30	17	6,5	
REC55320-95311AL	55320-95311	DF200/225/250 (V6) DF300/A DF300B, DF325A	(2010-25) (2010-25) (2018-25)	0,03 0,07	inch	1,58	0,47	1,18	0,67	0,26	

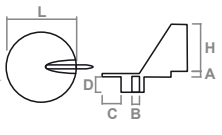
REF	OEM		 (kg)	 (lbs)	L	H	A	B	C	D			
 REC55321-87J01	55321-87J01	DF2.5 DF4/5/6 DF4A/5A/6A DF8A/AR, DF9.9A/AR DF9.9/15 DF9.9B, DF15A, DF20A DF20R, DF25R V2 DF25A/30A/40A/50A/60A	(2010-25) (2010-16) (2017-25) (2010-24) (2010-13) (2014-25) (2010-14)	0,01 0,02	mm	7	20	6,50					
 REC55321-87J01AL	55321-87J01	DF70A/75A/80A/90A/100B DF90/100/115/140 DF100C/A, 115A/B, 140A/B DF150/A, DF175/A, DF200/A DF200/225/250 (V6) DF300/A DF300B, DF325A	(2010-25) (2010-12) (2014-25) (2010-25) (2010-25) (2010-25) (2018-25)	0,01 0,01	inch	0,28	0,79	0,26					
 REC676-11325-00	11281-94400	DT8-DT65 DF60-DF70	(1988-00) (1998-09)	0,03 0,06	mm	25	15	22	7				
 REC676-11325-00AL	11281-94400			0,01 0,02	inch	0,99	0,59	0,87	0,21				
 REC55300-95500	55300-95500	DF8A/AR, DF9.9A/AR DF25A, DF30A	(2010-24) (2020-25)	0,08 0,18	mm	76	10	20	38	6,5			
 REC55300-95500AL	55300-95500	DF40A, DF50A, DF60A	(2010-25)	0,03 0,07	inch	2,99	0,39	0,79	1,50	0,26			
 REC55321-90L00	55321-90L00			0,05 0,11	mm	48	12	18	M6				
		DF9.9/15	(2010-13)										
 REC55321-90L00A	55321-90L00			0,01 0,03	inch	1,89	0,47	0,71	M6				
 REC55320-98400	55320-98400			0,05 0,11	mm	48	12	18	7				
		DT2-DT5	(1986-05)										
 REC55320-98400AL	55320-98400			0,02 0,05	inch	1,89	0,47	0,71	0,28				
 REC55320-94900	55320-94900	DF70A/75A/80A/90A, DF100B DF90/100/115/140 DF100C/A, DF115A/B, DF140A/B	(2010-25) (2010-12) (2014-25)	0,51 1,12	mm	196	40	14	6,50	176			
 REC55320-94900AL	55320-94900	DF150/A, DF175/A, DF200/A DF200/225/250 (V6) DF300/A DF300B, DF325A	(2010-25) (2010-25) (2010-25) (2018-25)	0,20 0,44	inch	7,72	1,58	0,55	0,26	6,93			
 REC55321-90J01	55321-90J01			0,08 0,17	mm	56	18	22	5	18	6		
		DF90/100/115/140 DF100C/A, DF115A/B, DF140A/B	(2010-12) (2014-25)										
 REC55321-90J01AL	55321-90J01			0,03 0,07	inch	2,21	0,71	0,87	0,20	0,71	0,24		
 REC11261-93J00	11261-93J00	DF15A DF60A, DF70A	(2013-23) (2010-23)										

REF	OEM		 (kg)	 (lbs)	L	H	A	B	C	D		
 REC55125-91L01	55125-91L01		0,14	0,31	mm	82	48	70	4	8,50	17	 
	DF20R, DF25R V2 DF25A, DF30A	(2010-14) (2020-25)										
 REC55125-91L01AL	55125-91L01		0,05	0,10	inch	3,23	1,89	2,76	0,16	0,33	0,67	
 REC55125-90J01	55125-90J01		0,22	0,49	mm	113	59	85		8,5		 
	DF70A/75A/80A/90A/100B(2010-25) DF90/100/115/140 DF100C/A, DF115A/B, DF140A/B DF150/A, DF175/A, DF200/A (2010-25)	(2010-12) (2014-25)										
 REC55125-90J01AL	55125-90J01		0,09	0,20	inch	4,45	2,32	3,35		0,33		
	DF200/225/250 (V6) DF300/A	(2010-25) (2010-25)										
 REC55125-95500	55125-87E01 55125-95500		0,19	0,42	mm	70	50	61	9	20		 
	DF60-DF70 DT90-DT100	(1998-09) (1990-00)										
 REC55125-95500AL	55125-87E01 55125-95500		0,08	0,17	inch	2,76	1,97	2,40	0,35	0,79		
 REC55125-94502	55125-94502		0,33	0,72	mm	98	67	21		11		 
	DT115-DT140	(1986-00)										
 REC55125-94502AL	55125-94502		0,12	0,26	inch	3,86	2,63	0,83		0,43		
 REC55120-87801	55120-87801		0,32	0,71	mm	89	61	7		21	4	 
	DT150-DT200-DT225	(1998-03)								$10 \times 1,25$		
 REC55120-87801AL	55120-87801		0,13	0,28	inch	3,50	2,40	0,28		0,83	0,16	

KITS

REF	CONTENT		
<sup>13</sup> Al RECKITS150-350AL			
<sup>12</sup> Mg RECKITS150-350M	REC55320-94900 --> x 1 REC55321-87J01 --> x 8 REC55320-95311 --> x 3	150 - 350	
<sup>30</sup> Zn RECKITS150-350ZN			
<sup>13</sup> Al RECKITS200-250AL			
<sup>12</sup> Mg RECKITS200-250M	REC55320-94900 --> x 1 REC55320-95311 --> x 3	200- 250	
<sup>30</sup> Zn RECKITS200-250ZN			
<sup>13</sup> Al RECKITS90-140AL			
<sup>12</sup> Mg RECKITS90-140M	REC55321-90J01 --> x 1 REC55321-87J01 --> x 4 REC55320-94900 --> x 1	90-140	
<sup>30</sup> Zn RECKITS90-140KITZN			
<sup>13</sup> Al RECKITS40-50AL			
<sup>12</sup> Mg RECKITS40-50M	REC55320-95311 --> x 2 REC55321-87J01 --> x 4 REC55125-95500 --> x 1	40-50	
<sup>30</sup> Zn RECKITS40-50ZN			

2



ANODES CANADA METAL

ÁNODOS CANADA METAL

ANODI CANADA METAL

ANODES CANADA METAL

	OEM	KG (kg)	Ø				
<sup>30</sup> Zn CM55300-95500	55300-95500	0,08		DF9.9 DF15	(2004-10) (1996-03)		
<sup>13</sup> Al CM55300-95500A	55300-95500	0,023		DF40, DF50 DF40A, DF50A, DF60A	(1999-10) (2010+)		
<sup>30</sup> Zn CM55320-98400	55320-98400	0,05	7mm	DF9.9, DF15	(1997-10)		
<sup>13</sup> Al CM55320-98400A	55320-98400	0,046					
<sup>30</sup> Zn CM55320-95310	55320-98311 55320-95310	0,08		DF25 --> DF300	(2000+)		
<sup>13</sup> Al CM55320-95310A	55320-98311 55320-95310	0,03					
<sup>30</sup> Zn CM55321-87J00	55321-87J00/1	0,02		DF8 --> DF300			
<sup>13</sup> Al CM55321-87J00A	55321-87J00/1	0,007				REC09280-22019 PAGB/T5783-M6X14	
<sup>30</sup> Zn CM41811-98500	41811-98500	0,05	M6	DT4, DT15 DF9.9, DF15			



		OEM	 (kg)	Ø				
	CM55321-94900	55320-94900	0,51					
	CM55321-94900A	55320-94900	0,21					
	CM55125-95500	55125-87E01	0,25					
	CM55125-95500A	55125-87E01	0,087					
	CM55321-93900	55321-93900 55320-93900	0,08					
	CM55321-93900A	55321-93900 55320-93900	0,02					
	CM55125-87D00	55125-87D00 55320-93900 55125-87801	0,34					
	CM55125-87D00A	55125-87D00 55320-93900 55125-87801	0,14					
	CM55125-96310	55125-96310	0,15					
	CM55125-96310A	55125-96310	0,07					
	CM55125-95301A	55125-95301	0,06					
	CM55125-94502	55125-94502	0,33					
	CM55320-98600	55320-98600	0,10					
	CM55320-98600A	55320-98600	0,034					
	CM55321-90J01	55321-90J01	0,10					
	CM55321-90J01A	55321-90J01	0,036					
	CM11130-94600	11130-94600	0,02					
	CM11130-94600A	11130-94600	0,01				PAGB/T5783-M6X14	

KITS ANODES CANADA METAL

KITS ÁNODOS CANADA METAL

KIT ANODI CANADA METAL

KITS ANODES CANADA METAL

	REF		
	1	CMSZ4050KITA	40 --> 50 hp
	2	CMSZ90140KITA	90 --> 140 hp



## GASKETS &amp; SCREWS

## JUNTAS Y TORNILLOS

## GUARNIZIONI E VITI

## JOINTS ET VIS

## SS SCREW

## TORNILLO INOX

## VITE INOX

## VIS INOX

	REF	OEM	ANODE	
1	PAGB/T5783-M6X14	09103-06281	REC55321-87J01	6 x 14
2	REC09116-06121	09116-06121	REC55320-94900	6 X 25
3	REC09116-06094	09116-06094	REC55320-95311AL	6 X 15
4	PAGB/T818-M6X14	09128-06221	REC55321-87J01	6 x 14



## O-RING

## JUNTA TÓRICA

## FASCIA TONDA

## JOINT TORIQUE

REF	OEM	ANODE
REC09280-22019	09280-22019	REC55321-87J01



## GASKET, ANODE COVER

## JUNTA TAPA DEL ÁNODO

## GUARNIZIONE, COPERCHIO ANODO

## JOINT, COUVERCLE D'ANODE

REF	OEM	
REC11265-87E10	11265-87E00/-H17	DF25 --> DF140









# Engine parts

ENGINE PARTS

PARTES DEL MOTOR

PARTI MOTORE

PIÈCES MOTEUR

<p>REC10W30U3 REC10W30U6 REC10W40U3 REC10W40U6</p> 	<p>+ INFO INSTAL. P. 18</p>	<p>RECGREU1 RECGREU12</p> 	<p>+ INFO INSTAL. P. 45</p>		<p>+ INFO INSTAL. P. 32</p>	<p></p>	<p>+ INFO INSTAL. P. 33</p>	<p></p>	<p>+ INFO INSTAL. P. 36</p>
--	---	---	---	---	---	---	---	--	---

4 STROKES

4 TIEMPOS

4 TEMPI

4 TEMPS

DF9.9, DF15 (2004-12)

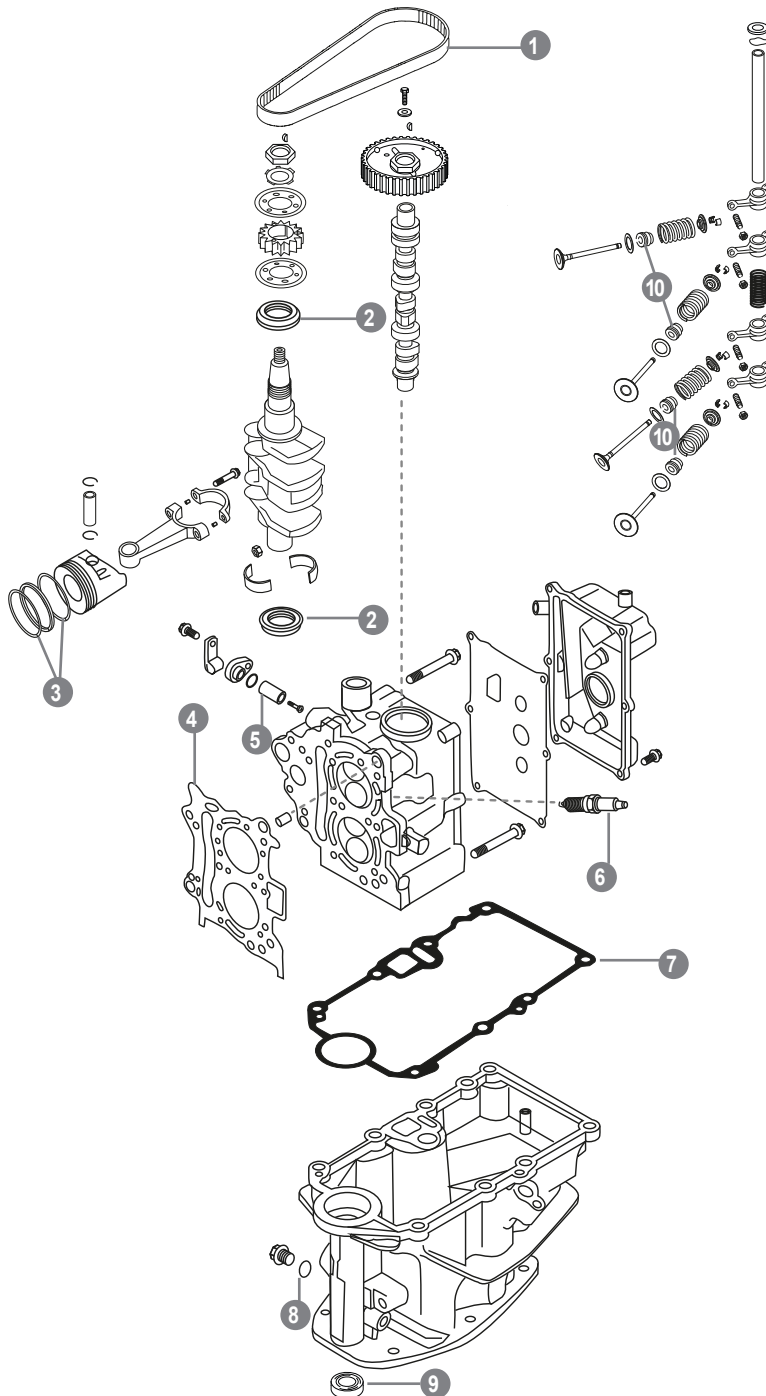

REF	OEM					UN.	
1	REC12761-93E0	12761-93E0	BELT	CORREA	CINGHIA	COURROIE	1
2	REC09283-32048	09283-32048	OIL SEAL	RETEN 32X44X6.5	GUARNIZIONE DELL'OLIO	JOINT D'HUILE	2
3	REC12140-02C10	12140-02C10	RING SET, PISTON STD	AROS DE PISTON STD	KIT FASCE PISTONE	KIT SEGMENTS	2
4	REC11141-94J0	11141-94J0	CYLINDER HEAD GASKET	JUNTA CULATA	GUARNIZIONE TESTA	JOINT DE CULASSE	1
5	REC6BL-11325-00AL	55321-99E0	ALUMINIUM ANODE	ANODO ALUMINIO	ANODO ALLUMINIO	ANODE ALUMINIUM	1
6	NGKCPR6EA-9	09482-00L04	SPARK-PLUG	BUJIA	CANDELA	BOUGIE	1
7	REC11489-93E11	11489-93E11	OIL PAN GASKET	JUNTA CARTER	GUARNIZIONE COPPA DELLOLIO	JOINT DE CARTER D'HUILE	1
8	REC09168-12017	09168-12017	GASKET DRAIN OIL	JUNTA TAPON CARTER	GUARNIZIONE TAPPO DE COPPA	JOINT DE VIDANGE	1
9	REC09282-12010	09282-12010	OIL SEAL	RETEN ACEITE	PARAOLIO	JOINT SPI	1
10	PAF166-010003	09289-05006	SEAL VALVE STEM	RETÉN VÁLVULA	PARAOLIO VALVOLA	JOINT DE QUEUE DE SOUPAPE	4

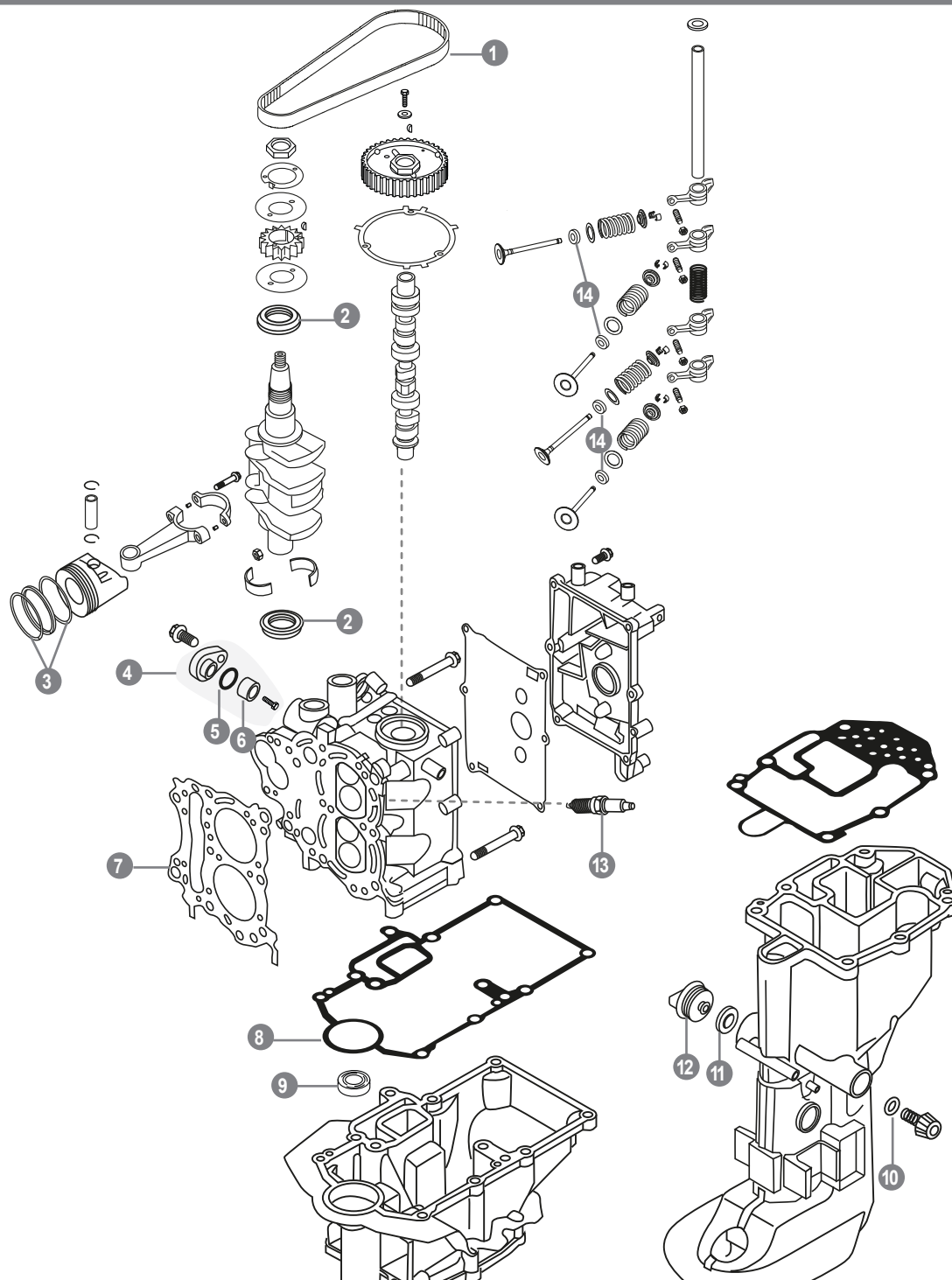

REF	OEM					UN.	
1	REC12761-93ELO	12761-93ELO	BELT	CORREA	CINGHIA	COURROIE	1
2	REC09283-32048	09283-32048	OIL SEAL	RETEN 32X44X6.5	GUARNIZIONE DELL'OLIO	JOINT D'HUILE	2
3	REC12140-89L10	12140-89L10	RING SET, PISTON STD	AROS DE PISTON STD	FASCE PISTON	KIT DE SEGMENTS	2
4	REC11261-93J00	11261-93J00	COVER PROTECTION ANODE ASSY	TAPA ANODO COMPLETA	COPERCHIO PROTEZIONE ANODO COMPLETO	COUVERCLE COMPLET DE PROTECTION ANODE	1
5	REC09280-22019	09280-22019	ANODE O-RING	TORICA ANODO	FASCIA TONDA ANODO	JOINT TORIQUE	1
6	REC55321-87J01AL	55321-87J01	ALUMINIUM ANODE	ANODO ALUMINIO	ANODO ALLUMINIO	ANODE ALUMINIUM	1
7	REC11141-89L00	11141-89L00	CYLINDER HEAD GASKET	JUNTA CULATA	GUARNIZIONE TESTA	JOINT DE CULASSE	1
8	REC51211-89L00	51211-89L00	OIL PAN GASKET	JUNTA CARTER	GUARNIZIONE COPPA DELL'OLIO	JOINT DE CARTER D'HUILE	1
9	REC09282-12010	09282-12L04	OIL SEAL	RETEN ACEITE	PARAOLIO	JOINT SPI	1
10	REC09168-12017	09168-12017	GASKET DRAIN OIL	JUNTA TAPON CARTER	GUARNIZIONE TAPPO DE COPPA	JOINT DE VIDANGE	1
11	REC17914-93J00	17914-93J00	GASKET	JUNTA	GUARNIZIONE	JOINT	1
12	REC17913-93J00	17913-93J00	WATER FLUSH PLUG	TAPON AGUA	TAPPO ACQUA	BOUCHON DE REFROIDISSEMENT	1
13	NGKCPR6EA-9	09482-00L04	SPARK-PLUG	BUJIA	CANDELA	BOUGIE	1
14	PAF166-010003	09289-05006	SEAL VALVE STEM	RETÉN VÁLVULA	PARAOLIO VALVOLA	JOINT DE QUEUE DE SOUPAPE	4

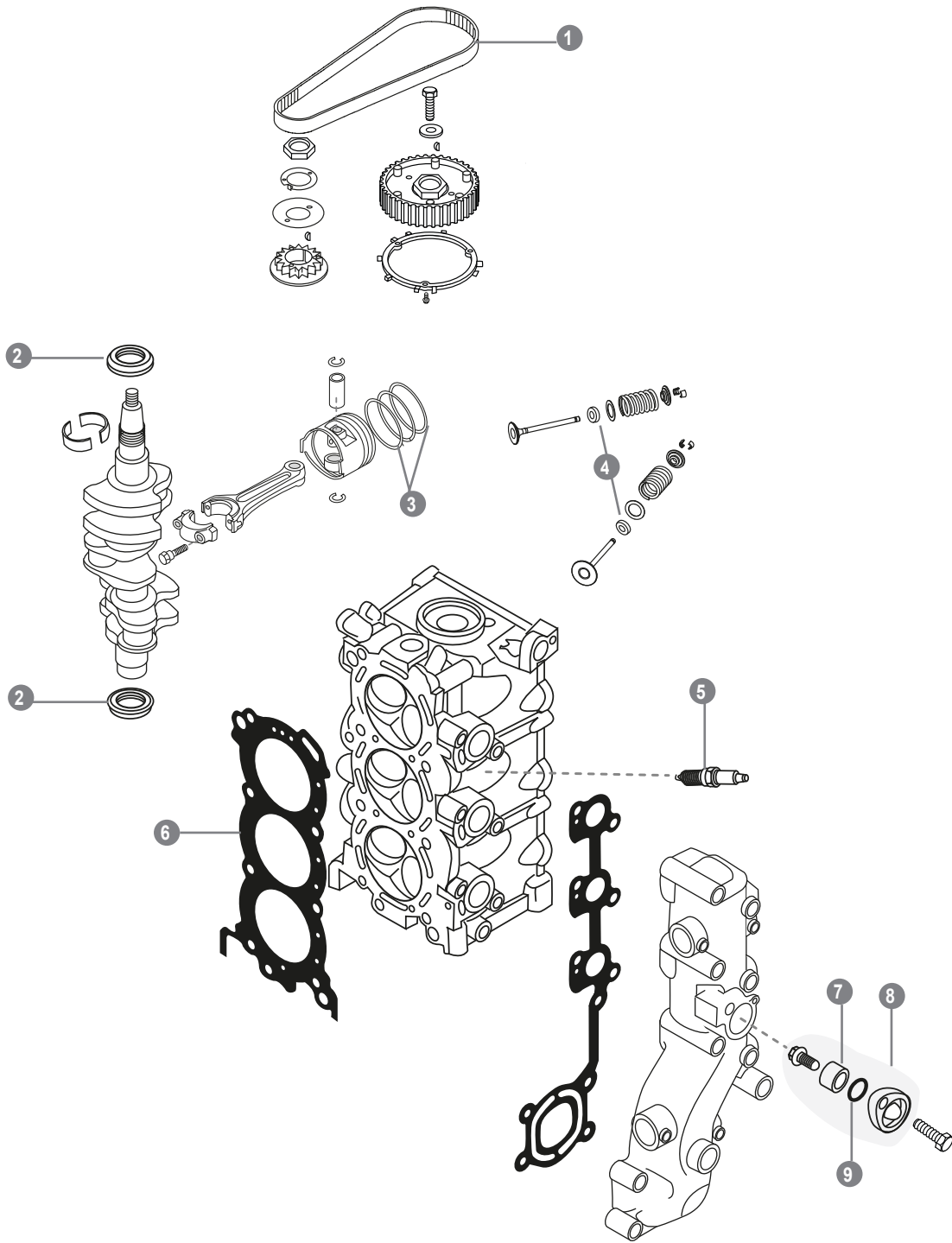

REF	OEM					UN.	
1	REC12761-94L10	12761-94L10	BELT	CORREA	CINGHIA	COURROIE	1
2	REC09283-32048	09283-32048	OIL SEAL	RETEN 32X44X6.5	GUARNIZIONE DELL'OLIO	JOINT D'HUILE	2
3	REC12140-89L10	12140-89L10	RING SET, PISTON STD (2021+)	AROS DE PISTON STD (2021+)	FASCE PISTON (2021+)	KIT DE SEGMENTS (2021+)	3
	REC12140-89L00	12140-89L00	RING SET, PISTON STD (-2020)	AROS DE PISTON STD (-2020)	FASCE PISTON (-2020)	KIT DE SEGMENTS (-2020)	
4	REC09289-05008	09289-05008	OIL SEAL	RETEN	GUARNIZIONE DELL'OLIO	JOINT D'HUILE	6
5	NGKDCPR6E	09482-00446	SPARK-PLUG	BUJIA	CANDELA	BOUGIE	3
6	REC11141-94L00	11141-94L00	CYLINDER HEAD GASKET	JUNTA CULATA	GUARNIZIONE TESTA	JOINT DE CULASSE	1
7	REC55321-87J01AL	55321-87J01	ALUMINIUM ANODE	ANODO ALUMINIO	ANODO ALLUMINIO	ANODE ALUMINIUM	1
8	REC11261-93J00	11261-93J00	COVER PROTECTION ANODE ASSY	TAPA ANODO COMPLETA	COPERCHIO PROTEZIONE ANODO COMPLETO	COUVERCLE COMPLET DE PROTECTION ANODE	1
9	REC09280-22019	09280-22019	ANODE O-RING	TORICA ANODO	FASCIA TONDA ANODO	JOINT TORIQUE	1

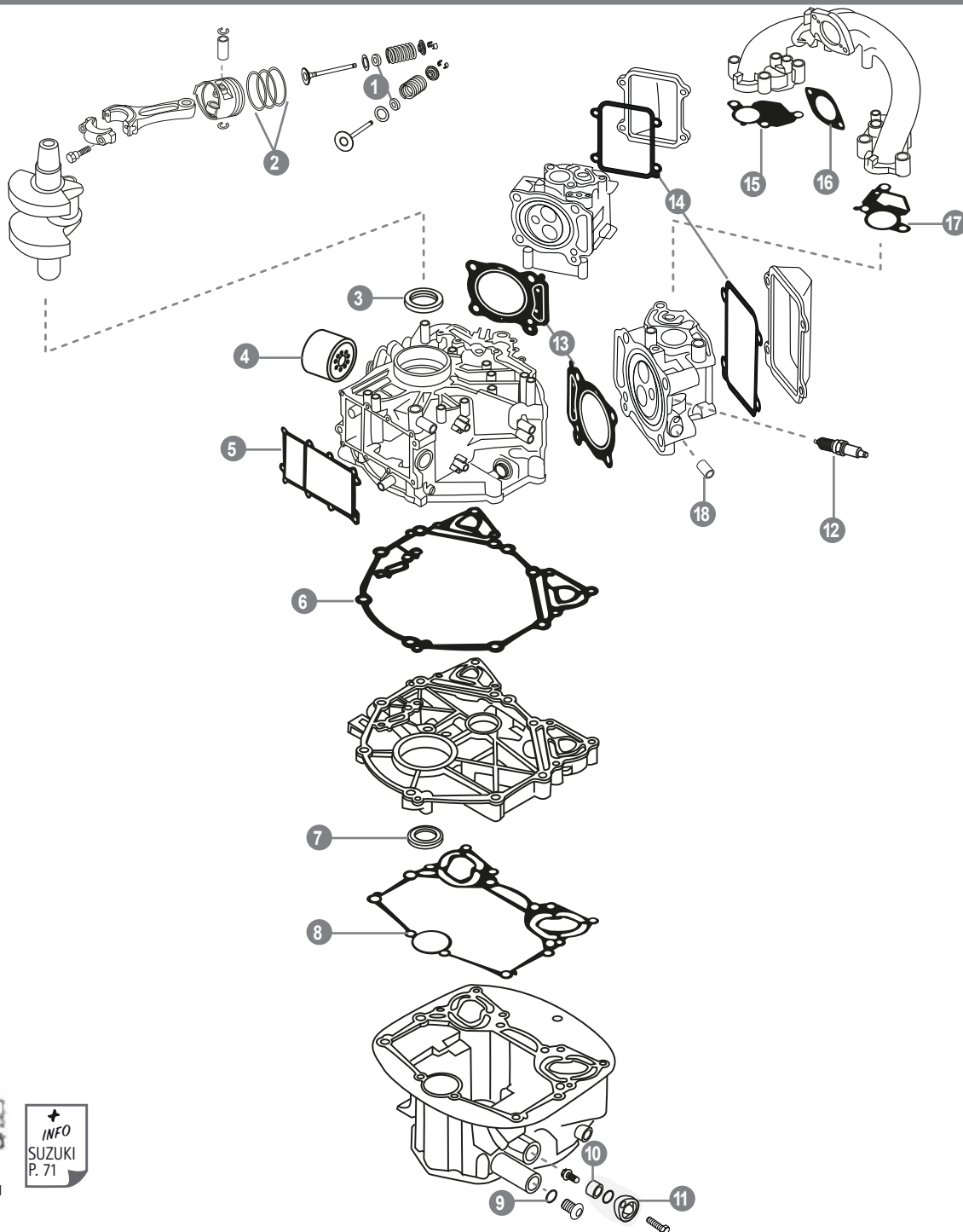

+  
 INFO  
 SUZUKI  
 P. 71

REC11410-95811

REF	OEM					UN.	
1	PAF166-010003	09289-05006	SEAL VALVE STEM	RETEN VÁLVULA	PARAOLIO VALVOLA	JOINT DE QUEUE DE SOUPAPE	4
2	REC12140-75F30	12140-75F30	RING SET, PISTON STD	AROS DE PISTON STD	FASCE PISTON	KIT DE SEGMENTS	2
3	REC09283-32048	09283-32048	OIL SEAL	RETEN 32X44X6.5	GUARNIZIONE DELL'OLIO	JOINT D'HUILE	1
4	REC16510-87J00	16510-87J01	OIL FILTER	FILTRO ACEITE	FILTRO OLIO	FILTRE A HUILE	1
5	REC11219-95J01	11219-95J01	GASKET	JUNTA	GUARNIZIONE	JOINT	1
6	REC11351-95J01	11351-95J01	GASKET	JUNTA	GUARNIZIONE	JOINT	1
7	REC09283-34014	09283-34014	OIL SEAL	RETEN 34X46X8	GUARNIZIONE DELL'OLIO	JOINT D'HUILE	1
8	REC11489-95J01	11489-95J01	OIL PAN GASKET	JUNTA CARTER	GUARNIZIONE COPPA DELLOLIO	JOINT DE CARTER D'HUILE	1
9	REC09168-12012	09168-12012	OIL DRAIN PLUG GASKET	JUNTA TAPON CARTER	GUARNIZIONE TAPPO	JOINT DE VIDANGE	1
10	REC55321-87J01AL	55321-87J01	ALUMINIUM ANODE	ANODO ALUMINIO	ANODO ALLUMINIO	ANODE ALUMINIUM	1
11	REC11261-93J00	11261-93J00	COVER ANODE ASSY	TAPA ANODO COMPLETA	COPERCHIO ANODO COMPLETO	COUVERCLE COMPLET D'ANODE	1
12	NGKBKR6E	09482-00427	SPARK-PLUG	BUJIA	CANDELA	BOUGIE	2
13	REC11141-95J00	11141-95J00	CYLINDER HEAD GASKET	JUNTA CULATA	GUARNIZIONE TESTA	JOINT DE CULASSE	2
14	REC11189-95J00	11189-95J00	GASKET	JUNTA	GUARNIZIONE	JOINT	2
15	REC13122-95J00	13122-95J00	GASKET INTAKE MANIFOLD	JUNTA COLECTOR ADM.	GUARN. COLLETTORE ASPIRAZIONE	JOINT COLLECTEUR D'ADMISSION	1
16	REC13125-95J00	13125-95J00	CARBURETOR GASKET	JUNTA CARBURADOR	GUARNIZIONE CARBURATORE	JOINT DU CARBURATEUR	1
17	REC13119-95J00	13119-95J00	GASKET	JUNTA	GUARNIZIONE	JOINT	1
18	REC55321-95J00	55321-95J00	ANODE	ANODO	ANODO	ANODE	2

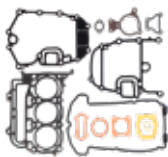
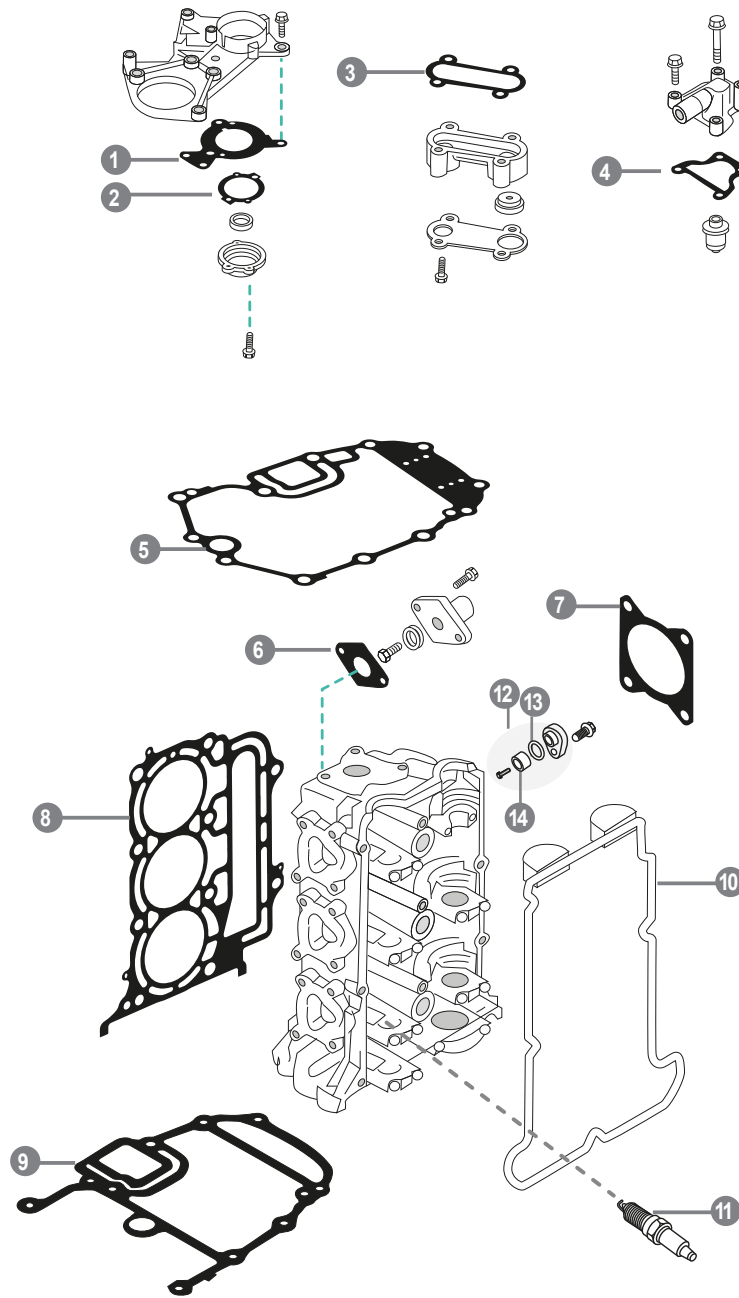

REC11400-87804

INFO  
SUZUKI  
P. 71

	REF	OEM				UN.	
1	REC11413-87J00	11413-87J00	UPPER GASKET	JUNTA SUPERIOR	GUARNIZIONE SUPERIORE	JOINT SPI	1
2	REC11433-87J00	11433-87J00	SEAL UPPER, GASKET	JUNTA DEL RETÉN SUPERIOR	GUARNIZIONE PARAOLIO SUPERIORE	JOINT SPI	1
3	REC17616-87J00	17616-87J00	PRESURE VALVE, GASKET	JUNTA DE LA VÁLVULA DE PRESIÓN	GUARNIZIONE, VALVOLA PRESIONE	JOINT SOUPAPE DE PRESSION	1
4	REC17685-87D10	17685-87D10	THERMOSTAT COVER GASKET	JUNTA TAPA DE TERMOSTATO	GUARNIZIONE COPERCHIO TERMOSTATO	JOINT LOGEMENT THERMOSTAT	1
5	REC11489-87J00	11489-87J00	OIL PAN, GASKET	JUNTA DEL CÁRTER	GUARNIZIONE COPPA OLIO	JOINT DE CARTER	1
6	REC11265-87E10	11265-87E10	GASKET, COVER ANODE	JUNTA TAPA DEL ÁNODO	GUARNIZIONE COPERCHIO ANODO	JOINT D'ANODE D'ECHAPPEMENT	1
7	REC13421-87J00	13421-87J00	THRPOTTLE BODY GASKET	JUNTA DEL CUERPO DE MARIPOSA	GUARNIZIONE CORPO FARFALLATO	JOINT DE THROTTLE BODY	1
8	REC11141-87J02	11141-87J02	CYLINDER HEAD, GASKET	JUNTA DE CULATA	GUARNIZIONE TESTATA	JOINT DE CULASSE	1
9	REC51211-87J00	51211-87J00	GASKET ENGINE	JUNTA BASE MOTOR	GUARNIZIONE BASE MOTORE	JOINT DE TÊTE MOTRICE	1
10	REC11189-87J00	11189-87J00	GASKET CYLINDER COVER	JUNTA TAPA DE BALANCÍN	GUARNIZIONE COPERCHIO PUNTERIE	JOINT COUVERCLE	1
11	NGKDCPR6E	09482-00446	SPARK-PLUG	BUJIA	CANDELA	BOUGIE	3
12	REC11261-93J00	11261-93J00	COVER ANODE ASSY	TAPA ANODO COMPLETA	COPERCHIO ANODO COMPLETO	COUVERCLE COMPLET D'ANODE	1
13	REC09280-22019	09280-22019	ANODE O-RING	TÓRICA ANODO	FASCIA TONDA ANODO	JOINT TORIQUE	1
14	REC55321-87J01AL	55321-87J01	ALUMINIUM ANODE	ANODO ALUMINIO	ANODO ALLUMINIO	ANODE ALUMINIUM	1

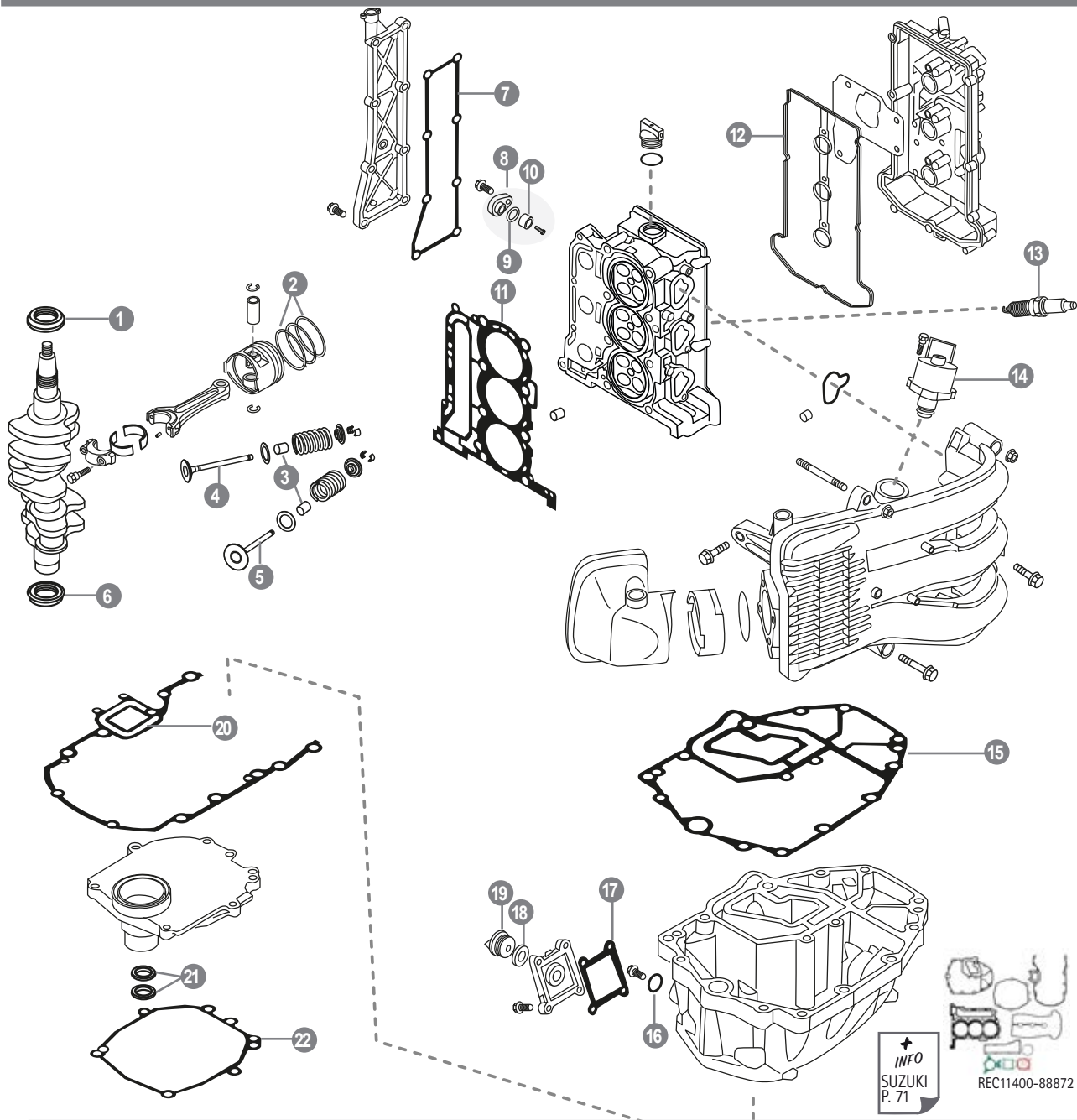

REF	OEM					UN.	
1	REC09283-37005	09283-37005	OIL SEAL	RETEN	GUARNIZIONE DELL'OLIO	JOINT D'HUILE	1
2	REC12140-88L01	12140-88L01	RING SET, PISTON STD	AROS DE PISTON STD	FASCE PISTON	KIT DE SEGMENTS	3
3	PAF166-010003	09289-05006	SEAL VALVE STEM	RETÉN VÁLVULA	PARAOILIO VALVOLA	JOINT DE QUEUE DE SOUPAPE	6
4	REC12915-73G20	12915-73G20	EXHAUST VALVE 21.5X5.5X81.3	VALVULA ESCAPE 21.5X5.5X81.3	VALVOLA DI SCARICO 21.5X5.5X81.3	SOUPAPE D'ÉCHAPPEMENT 21.5X5.5X81.3	3
5	REC12911-88L00	12911-88L00	INTAKE VALVE 26.6X5.5X80.2	VALVULA ADMISION 26.6X5.5X80.2	VALVOLA DI ASPIRAZIONE 26.6X5.5X80.2	SOUPAPE D'ADMISSION 26.6X5.5X80.2	3
6	REC12281-87J00	12281-87J00	OIL SEAL	RETEN 30X44X7	PARAOILIO	JOINT D'HUILE	1
7	REC14151-88L00	14151-88L00	GASKET	JUNTA	GUARNIZIONE	JOINT	1
8	REC11261-93J00	11261-93J00	COVER ANODE ASSY	TAPA ANODO COMPLETA	COPERCHIO ANODO COMPLETO	COUVERCLE COMPLET D'ANODE	1
9	REC09280-22019	09280-22019	ANODE O-RING	TORICA ANODO	FASCIA TONDA ANODO	JOINT TORIQUE	1
10	REC55321-87J01AL	55321-87J01	ALUMINIUM ANODE	ANODO ALUMINIO	ANODO ALLUMINIO	ANODE ALUMINIUM	1
11	REC11141-88L00	11141-88L00	CYLINDER HEAD GASKET	JUNTA CULATA	GUARNIZIONE TESTA	JOINT DE CULASSE	1
12	REC11189-88L00	11189-88L00	GASKET	JUNTA	GUARNIZIONE	JOINT	1
13	NGKDPCR6E	09482-00446	SPARK-PLUG	BUJIA	CANDELA	BOUGIE	3
14	REC18137-88L01	19137-88L02	SENSOR	SENSOR	SENSORE	CAPTEUR	1
15	REC11489-88L01	11489-88L01	OIL PAN, GASKET	JUNTA DEL CÁRTER	GUARNIZIONE COPPA OLIO	JOINT DE CARTER	1
16	REC09168-12012	09168-12012	OIL DRAIN PLUG GASKET	JUNTA TAPON CÁRTER	GUARNIZIONE TAPPO	JOINT DE VIDANGE	1
17	REC11552-88L00	11552-88L00	OIL PAN, GASKET	JUNTA DEL CÁRTER	GUARNIZIONE COPPA OLIO	JOINT DE CARTER	1
18	REC17914-93J00	17914-93J00	GASKET	JUNTA	GUARNIZIONE	JOINT	1
19	REC17913-93J00	17913-93J00	WATER FLUSH PLUG	TAPON AGUA	TAPPO ACQUA	BOUCHON DE REFROIDISSEMENT	1
20	REC51211-88L00	51211-88L00	GASKET ENGINE	JUNTA BASE MOTOR	GUARNIZIONE BASE MOTORE	JOINT DE TÊTE MOTRICE	1
21	REC09282-17009	09282-17011	OIL SEAL	RETEN	GUARNIZIONE DELL'OLIO	JOINT D'HUILE	2
22	REC51123-88L00	51123-88L00	GASKET	JUNTA	GUARNIZIONE	JOINT	1

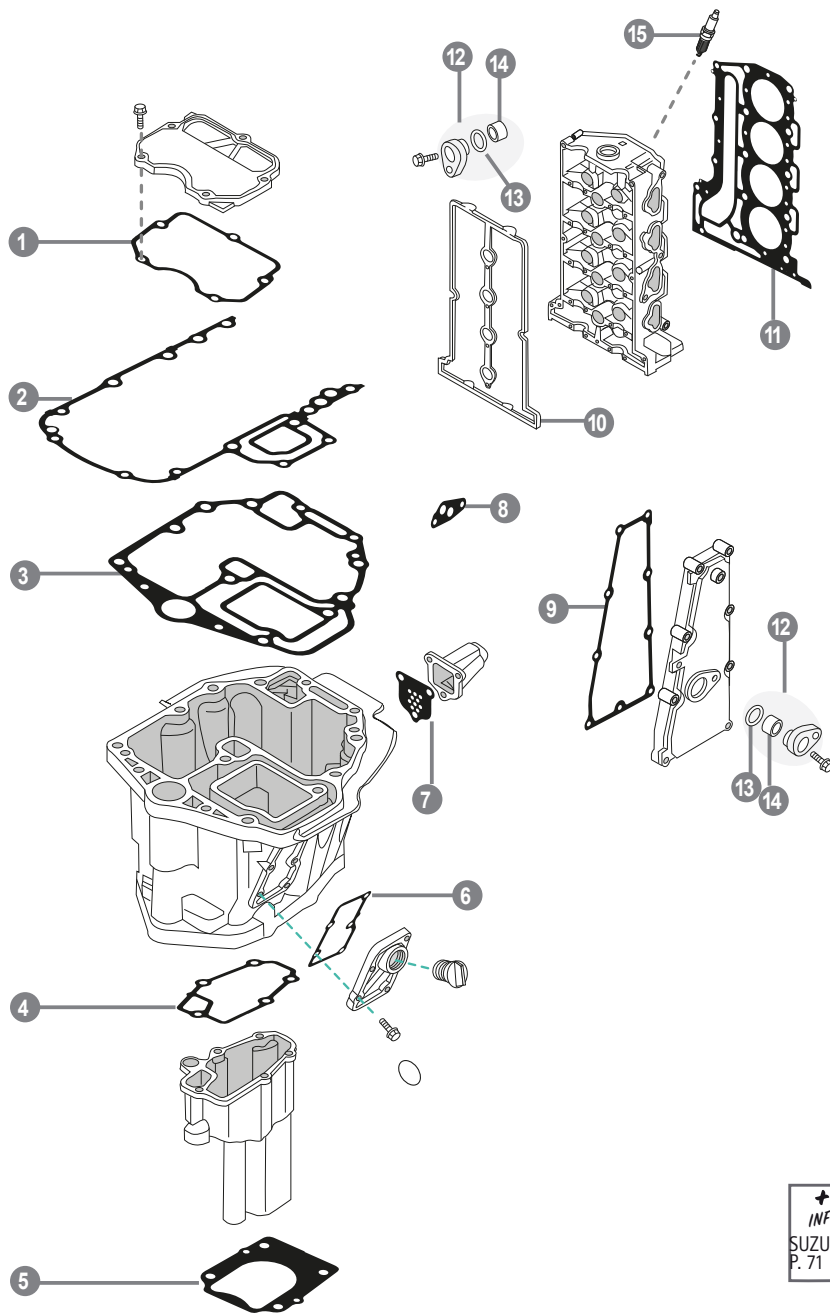

★  
INFO  
SUZUKI  
P. 71

REC11410-87851

	REF	OEM				UN.	
1	REC51123-87L00	51123-87L00	GASKET, MOUNT CASE COVER	JUNTA DE LA TAPA DE SILEMBLOCK	GUARNIZIONE COPERCHIO SILEMBLOCK	JOINT DE COUVERCLE SILEMBLOCK	1
2	REC51211-87L10	51211-87L00/10	ENGINE HOLDER GASKET	JUNTA BASE MOTOR	GUARNIZIONE BASE MOTORE	JOINT BASE MOTEUR	1
3	REC11489-87L00	11489-87L00	OIL PAN GASKET	JUNTA CARTER	GUARNIZIONE COPPA	JOINT DE CARTER	1
4	REC52331-87L00	52331-87L00	GASKET EXHAUST COVER	JUNTA TAPA DE ESCAPE	GUARNIZIONE COPERCHIO SCARICO	JOINT DE COUVERCLE D'ECHAPPEMENT	1
5	REC17472-87L00	17472-87L00	WATER PUMP GASKET	JUNTA BOMBA DE AGUA	GUARNIZIONE POMPA ACQUA	JOINT DE POMPE À EAU	1
6	REC52331-87L00	52331-87L00	GASKET EXHAUST COVER	JUNTA TAPA ESCAPE	GUARNIZIONE COPERCHIO SCARICO	JOINT DE COUVERCLE D'ECHAPPEMENT	1
7	REC11542-87L00	11542-87L00	MULTI EXHAUST GASKET	JUNTA MÚLTIPLE DE ESCAPE	GUARNIZIONE SCARICO MULTIPLO	JOINT DE PIPE D'ECHAPPEMENT	1
8	REC16539-87L00	16539-87L00	FILTER ADAPTER GASKET	JUNTA ADAPTADOR DE FILTRO	GUARNIZIONE ADATTATORE DE FILTRO	JOINT D'ADAPTATEUR DE FILTRE	1
9	REC14151-87L00	11151-87L00	GASKET EXHAUST COVER	JUNTA TAPA ESCAPE	GUARNIZIONE COPERCHIO SCARICO	JOINT DE COUVERCLE D'ECHAPPEMENT	1
10	REC11189-87L00	11189-87L00	GASKET CYLINDER HEAD COVER	JUNTA TAPA DE CULATA	GUARNIZIONE COPERCHIO TESTATA	JOINT DE COUVERTURE DE CULASSE	1
11	REC11141-87L00	11141-87L00	CYLINDER-HEAD GASKET	JUNTA DE CULATA	GUARNIZIONE TESTATA	JOINT DE CULASSE	1
12	REC11261-93J00	11261-93J00	COVER ANODE ASSY	TAPA ANODO COMPLETA	COPERCHIO ANODO COMPLETO	COUVERCLE COMPLET D'ANODE	2
13	REC09280-22019	09280-22019	ANODE O-RING	TORICA ANODO	FASCIA TONDA ANODO	JOINT TORIQUE	2
14	REC55321-87J01AL	55321-87J01	ALUMINIUM ANODE	ANODO ALUMINIO	ANODO ALLUMINIO	ANODE ALUMINIUM	2
15	NGKDCPR6E	09482-00446	SPARK-PLUG	BUJIA	CANDELA	BOUGIE	4

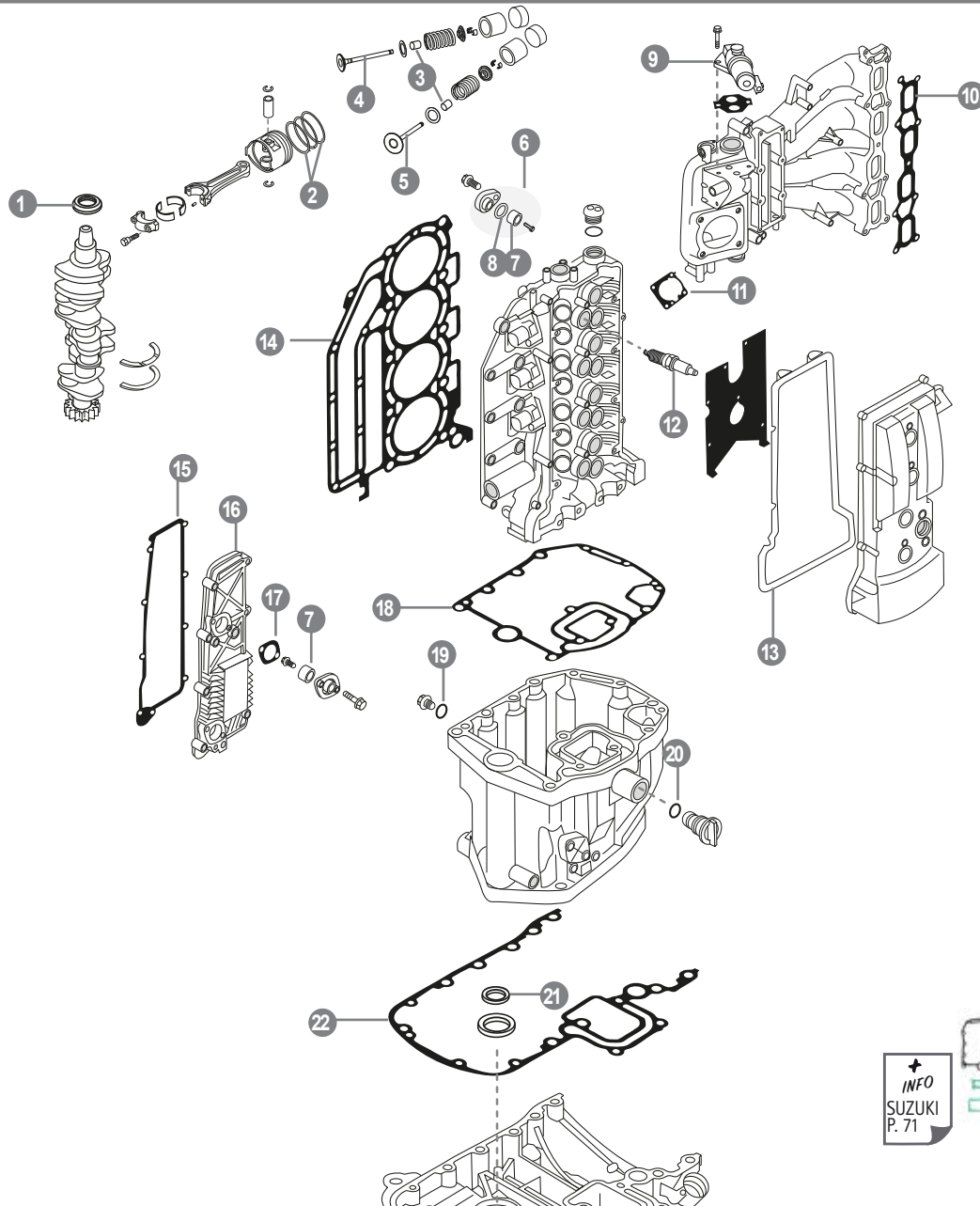

INFO  
SUZUKI  
P. 71

REC11410-90823

REF	OEM				UN.			
1	REC09283-52004	09283-52004	OIL SEAL	RETEN 52X70X10	PARAOLIO	JOINT D'HUILE	1	
2	REC12140-86FA0	12140-86FA0	RING SET, PISTON STD	AROS DE PISTON STD	FASCE PISTON	KIT DE SEGMENTS	4	
3	REC09289-06003	09289-06003	OIL SEAL	RETEN 6X13.6X10.2	PARAOLIO	JOINT D'HUILE	8	
4	REC12911-86FA2	12911-86FA2	INTAKE VALVE 33X6X86.2	VALVULA ADMISION 33X6X86.2	VALVOLA DI ASPIRAZIONE 33X6X86.2	SOUPAPE D'ADMISSION 33X6X86.2	4	
5	REC12915-86FA1	12915-86FA1	EXHAUST VALVE 28X6X86	VALVULA ESCAPE 28X6X86	VALVOLA DI SCARICO 28X6X86	SOUPAPE D'ÉCHAPPEMENT 28X6X86	4	
6	REC11261-93J00	11261-93J00	COVER ANODE ASSY	TAPA ANODO COMPLETA	COPERCHIO ANODO COMPLETO	COUVERCLE COMPLET ANODE	1	
7	REC55321-87J01AL	55321-87J01	ALUMINIUM ANODE	ANODO ALUMINIO	ANODO ALLUMINIO	ANODE ALUMINIUM	2	
8	REC09280-22019	09280-22019	ANODE O-RING	TORICA ANODO	FASCIA TONDA ANODO	JOINT TORIQUE	1	
9	REC18137-77E00	18137-77E00	VALVE IAC	VALVULA IAC	VALVOLA IAC	VANNE IAC	1	
10	REC13119-90J00	13119-90J00	MANIFOLD GASKET	JUNTA COLECTOR	GUARNIZIONE COLLETTORE	JOINT DE COLLECTEUR	1	
11	REC13421-90J02	13421-90J02	GASKET, THROTTLE BODY	JUNTA CUERPO ACELER.	GUARN. CORPO FARFALLATO	JOINT DE THROTTLE BODY	1	
12	NGKBKR6E	09482-00427	SPARK-PLUG	BUJIA	CANDELA	BOUGIE	4	
13	REC11189-90J00	11189-90J00	GASKET	JUNTA	GUARNIZIONE	JOINT	1	
14	REC11141-90J01	11141-90J01	CYLINDER HEAD GASKET	JUNTA CULATA	GUARNIZIONE TESTA	JOINT DE CULASSE	1	
15	REC14151-90J00	14151-90J00	RECTIFIER GASKET	JUNTA RECTIFICADOR	GUARNIZIONE RETTIFICATORE	JOINT DE REGULATEUR	1	
16	REC32800-90J00	32800-90J00	REGULATOR RECTIFIER	REGULADOR RECTIFICADOR	REGOLATORE RETTIFICATORE	REGULATEUR RECTIFIEUR	1	
	REC32800-90J20	32800-90J20	(2004-05)				1	
17	REC11265-87E10	11265-87E10	GASKET	JUNTA	GUARNIZIONE	JOINT	1	
18	REC11489-90J00	11489-90J00	OIL PAN GASKET	JUNTA CARTER	GUARNIZIONE COPPA	JOINT DE CARTER	1	
19	REC09168-12012	09168-12012	OIL DRAIN PLUG GASKET	JUNTA TAPON CARTER	GUARNIZIONE TAPPO	JOINT DE VIDANGE	1	
20	REC09280-13005	09280-13005	O-RING	TÓRICA	FASCIA TONDA	JOINT TORIQUE	1	
21	REC09282-24003	09282-24003	OIL SEAL	RETEN 24X36X6	PARAOLIO	JOINT D'HUILE	1	
	REC51211-90J10	51211-90J10	(-681517)					
22	REC51211-90J2	51211-90J20	(681518+)	ENGINE HOLDER GASKET	JUNTA BASE MOTOR	GUARNIZIONE BASE MOTORE	JOINT DE TETE MOTICE	1

DF100A, DF115A, DF140A (2012-21)  
DF140 (2002-12)

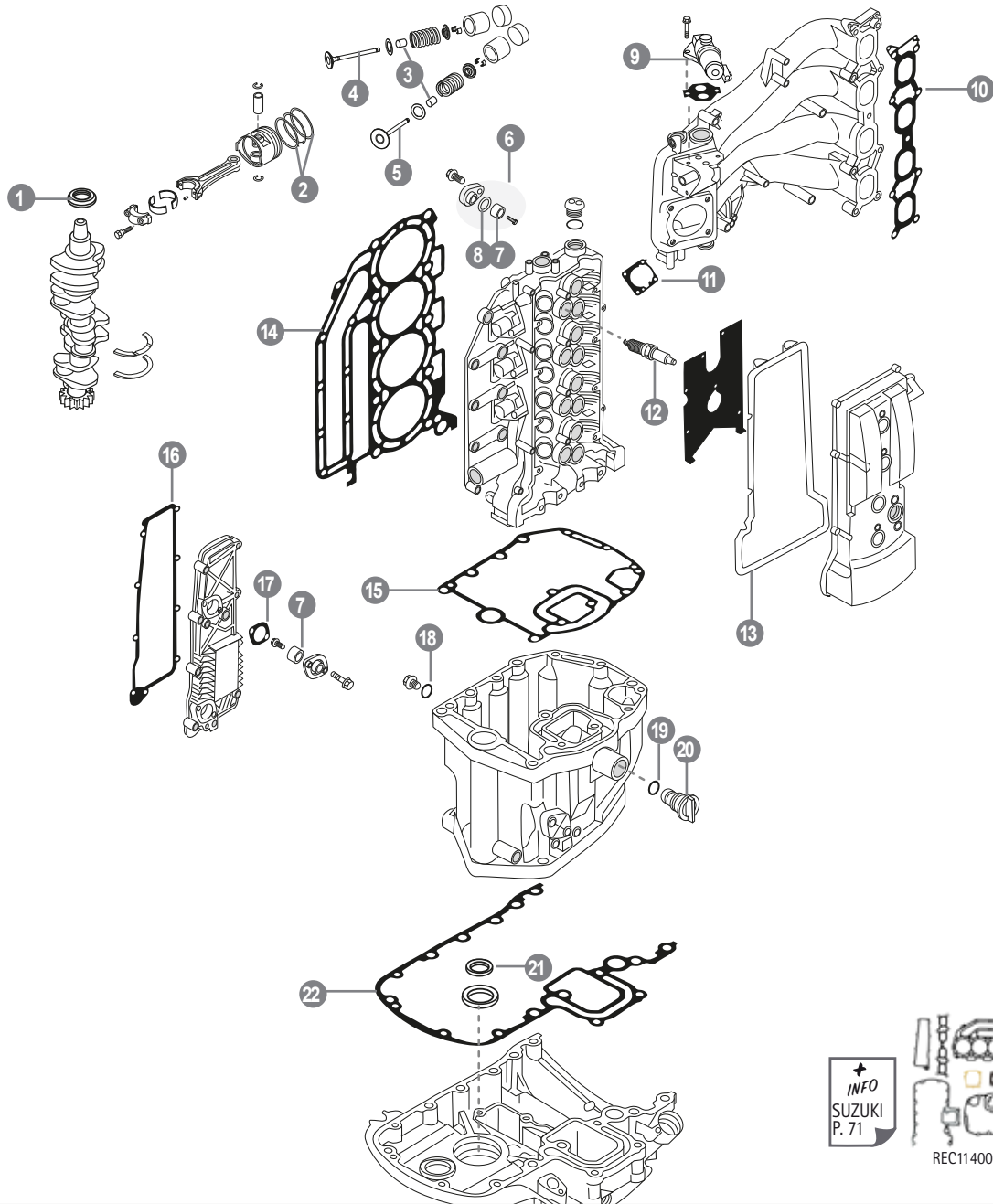

INFO  
SUZUKI  
P. 71

REC11400-92863

REF	OEM					UN.	
1	REC09283-52006	09283-52006	OIL SEAL	RETEN 52X70X10	PARAOLIO	JOINT D'HUILE	1
2	REC12140-92J10	12140-92J10	RING SET, PISTON STD	AROS DE PISTON STD	FASCE PISTON	KIT DE SEGMENTS	4
3	REC09289-06003	09289-06003	OIL SEAL	RETEN 6X13.6X10.2	PARAOLIO	JOINT D'HUILE	8
4	REC12911-86FA2	12911-86FA2	INTAKE VALVE 33X6X86.2	VALVULA ADMISION 33X6X86.2	VALVOLA DI ASPIRAZIONE 33X6X86.2	SOUPAPE D'ADMISSION 33X6X86.2	4
5	REC12915-86FA1	12915-86FA1	EXHAUST VALVE 28X6X86	VALVULA ESCAPE 28X6X86	VALVOLA DI SCARICO 28X6X86	SOUPAPE D'ÉCHAP. 28X6X86	4
6	REC11261-93J00	11261-93J00	COVER ANODE ASSY	TAPA ANODO COMPLETA	COPERCHIO ANODO COMPLETO	COUVERCLE COMPLET ANODE	1
7	REC55321-87J01AL	55321-87J01	ALUMINIUM ANODE	ANODO ALUMINIO	ANODO ALLUMINIO	ANODE ALUMINIUM	2
8	REC09280-22019	09280-22019	ANODE O-RING	TORICA ANODO	FASCIA TONDA ANODO	JOINT TORIQUE	1
9	REC18137-77E00	18137-77E00	VALVE IAC	VALVULA IAC	VALVOLA IAC	VANNE IAC	1
10	REC13119-90J00	13119-90J00	MANIFOLD GASKET	JUNTA COLECTOR	GUARNIZIONE COLLETTORE	JOINT DE COLLECTEUR	1
11	REC13421-90J02	13421-90J02	GASKET, THROTTLE BODY	JUNTA CUERPO ACELER.	GUARN. CORPO FARFALLATO	JOINT DE THROTTLE BODY	1
12	NGKBKR6E	09482-00427	SPARK-PLUG	BUJIA	CANDELA	BOUGIE	4
13	REC11189-90J00	11189-90J00	GASKET	JUNTA	GUARNIZIONE	JOINT	1
14	REC11141-92J01	11141-92J01	CYLINDER HEAD GASKET	JUNTA CULATA	GUARNIZIONE TESTA	JOINT DE CULASSE	1
15	REC11489-90J00	11489-90J00	OIL PAN GASKET	JUNTA CARTER	GUARNIZIONE COPPA	JOINT DE CARTER	1
16	REC14151-90J00	14151-90J00	RECTIFIER GASKET	JUNTA RECTIFICADOR	GUARNIZIONE RETTIFICATORE	JOINT DE REGULATEUR	1
17	REC11265-87E10	11265-87E10	GASKET	JUNTA	GUARNIZIONE	JOINT	1
18	REC09168-12012	09168-12012	OIL DRAIN PLUG GASKET	JUNTA TAPON CARTER	GUARNIZIONE TAPPO	JOINT DE VIDANGE	1
19	REC17914-93J00	17914-93J00	GASKET	JUNTA	GUARNIZIONE	JOINT	1
20	REC17913-93J00	17913-93J00	WATER FLUSH PLUG	TAPON AGUA	TAPPO ACQUA	BOUCHON DE REFROIDISSEMENT	1
21	REC09282-24003	09282-24003	OIL SEAL	RETEN 24X36X6	PARAOLIO	JOINT D'HUILE	1
22	REC51211-90J2	51211-90J2	ENGINE HOLDER GASKET	JUNTA BASE MOTOR	GUARNIZIONE BASE MOTORE	JOINT DE TETE MOTICE	1

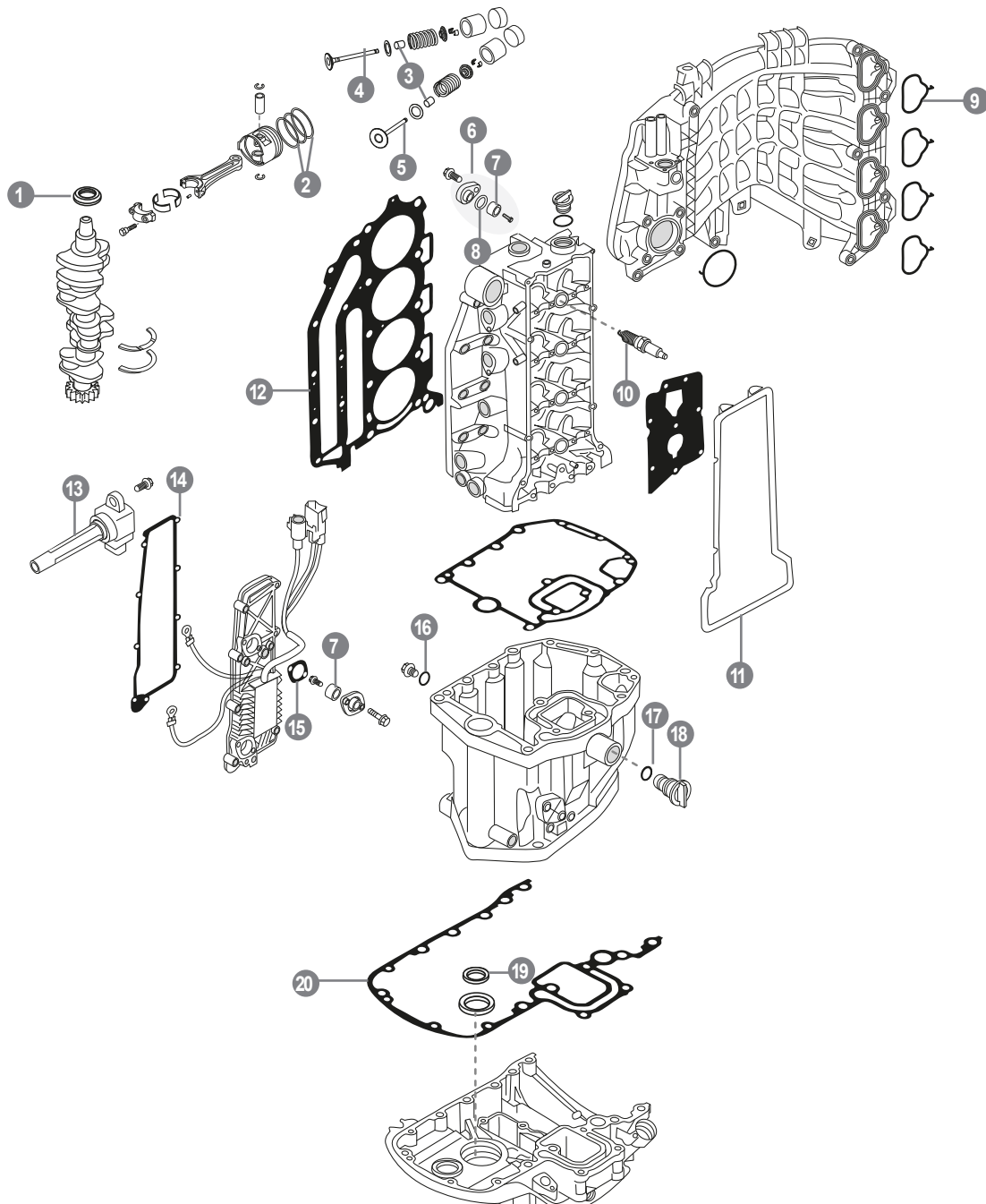

REF	OEM					UN.	
1	REC09283-52006	09283-52006	OIL SEAL	RETEN 52X70X10	PARAOLIO	JOINT D'HUILE	1
2	REC12140-92J10	12140-92J10	RING SET, PISTON STD	AROS DE PISTON STD	FASCE PISTON	KIT DE SEGMENTS	4
3	REC09289-06003	09289-06003	OIL SEAL	RETEN 6X13.6X10.2	PARAOLIO	JOINT D'HUILE	8
4	REC12911-86FA2	12911-86FA2	INTAKE VALVE 33X6X86.2	VALVULA ADMISION 33X6X86.2	VALVOLA DI ASPIRAZIONE 33X6X86.2	SOUPAPE D'ADMISSION 33X6X86,2	4
5	REC12915-86FA1	12915-86FA1	EXHAUST VALVE 28X6X86	VALVULA ESCAPE 28X6X86	VALVOLA DI SCARICO 28X6X86	SOUPAPE D'ÉCHAP. 28X6X86	4
6	REC11261-93J00	11261-93J00	COVER ANODE ASSY	TAPA ANODO COMPLETA	COPERCHIO ANODO COMPLETO	COUVERCLE COMPLET ANODE	1
7	REC55321-87J01AL	55321-87J01	ALUMINIUM ANODE	ANODO ALUMINIO	ANODO ALLUMINIO	ANODE ALUMINIUM	2
8	REC09280-22019	09280-22019	ANODE O-RING	TORICA ANODO	FASCIA TONDA ANODO	JOINT TORIQUE	1
9	REC13119-90J00	13119-90J00	MANIFOLD GASKET	JUNTA COLECTOR	GUARNIZIONE COLLETTORE	JOINT DE COLLECTEUR	1
10	NGKLR6E	09482-00649	SPARK-PLUG	BUJIA	CANDELA	BOUGIE	4
11	REC11189-90J00	11189-90J00	GASKET	JUNTA	GUARNIZIONE	JOINT	1
12	REC11141-99L00	11141-99L00	CYLINDER HEAD GASKET	JUNTA CULATA	GUARNIZIONE TESTA	JOINT DE CULASSE	1
13	REC33410-96L00	33410-99L00	COIL	BOBINA	BOBINA	BOBINE	1
14	REC14151-90J00	14151-90J00	RECTIFIER GASKET	JUNTA RECTIFICADOR	GUARNIZIONE RETTIFICATORE	JOINT DE REGULATEUR	1
15	REC11265-87E10	11265-87E10	GASKET	JUNTA	GUARNIZIONE	JOINT	1
16	REC09168-12012	09168-12012	OIL DRAIN PLUG GASKET	JUNTA TAPON CARTER	GUARNIZIONE TAPPO	JOINT DE VIDANGE	1
17	REC17914-93J00	17914-93J00	GASKET	JUNTA	GUARNIZIONE	JOINT	1
18	REC17913-93J00	17913-93J00	WATER FLUSH PLUG	TAPON AGUA	TAPPO ACQUA	BOUCHON DE REFROIDISSEMENT	1
19	REC09282-24003	09282-24003	OIL SEAL	RETEN 24X36X6	PARAOLIO	JOINT D'HUILE	1
20	REC51211-90J30	51211-90J30	ENGINE HOLDER GASKET	JUNTA BASE MOTOR	GUARNIZIONE BASE MOTORE	JOINT DE TETE MOTICE	1

A DF150, DF175 (2006-18) B DF150, DF175, DF200 (2019+)

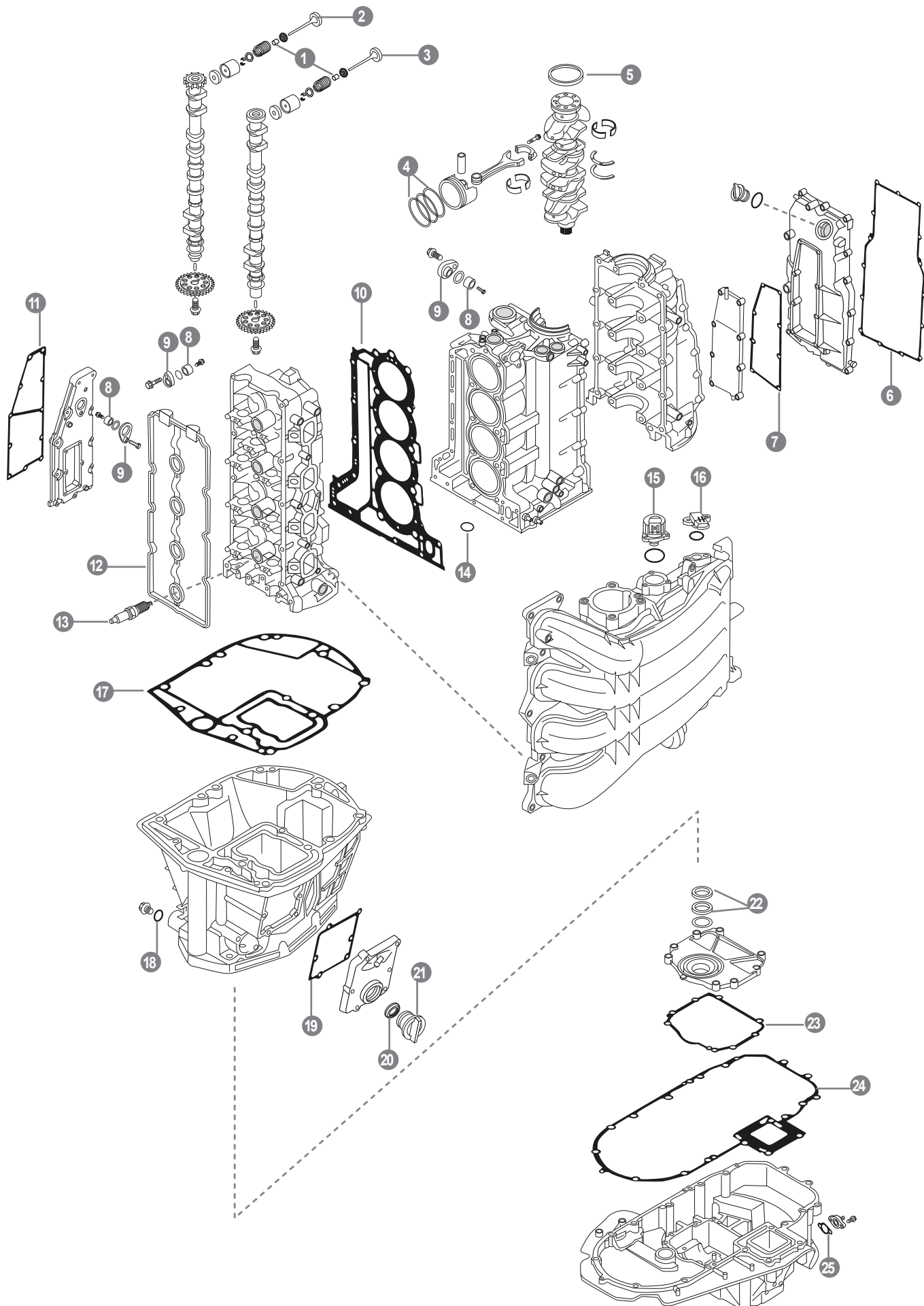

	REF	OEM				UN.	
1	PAF166-010003	09289-05006	SEAL VALVE STEM	RETEN VALVULA	PARAOILIO VALVOLA	JOINT DE QUEUE DE SOUPAPE	8
2	REC12915-93J60	12915-93J60	EXHAUST VALVE 31.5X5.5X92	VALVULA ESCAPE 31.5X5.5X92	VALVOLA DI SCARICO 31.5X5.5X92	SOUPAPE D'ECHAP. 31.5X5.5X92	4
3	REC12911-93J00	12911-93J00	INTAKE VALVE 35.85X5.5X92.1	VALVULA ADMISION 35.85X5.5X92.1	VALVOLA DI ASPIRAZIONE 35.85X5.5X92.1	SOUPAPE D'ADMISSION 35.85X5.5X92.1	4
4	A REC12140-96J00	12140-96J00	RING SET, PISTON STD	AROS DE PISTON STD	FASCE PISTON	KIT DE SEGMENTS	4
	B REC12140-96J10	11140-96J10					
5	REC09283-91001	09283-91001	OIL SEAL	RETEN	PARAOILIO	JOINT D'HUILE	1
6	REC11332-96J00	11332-96J00	GASKET	JUNTA	GUARNIZIONE	JOINT	1
7	REC11342-96J00	11342-96J00	GASKET	JUNTA	GUARNIZIONE	JOINT	1
8	REC55321-87J01AL	55321-87J01	ALUMINIUM ANODE	ANODO ALUMINIO	ANODO ALLUMINIO	ANODE ALUMINIUM	2
9	REC11261-93J00	11261-93J00	COVER ANODE ASSY	TAPA ANODO COMPLETA	COPERCHIO ANODO COMPLETO	COUVERCLE COMPLET ANODE	2
10	A REC11141-96J01	11141-96J01	CYLINDER HEAD GASKET	JUNTA CULATA	GUARNIZIONE TESTA	JOINT DE CULASSE	1
	B REC11141-96L00	11141-96L00					
11	REC14151-96J00	14151-96J00	GASKET	JUNTA	GUARNIZIONE	JOINT	1
12	REC11189-96J00	11189-96J00	GASKET	JUNTA	GUARNIZIONE	JOINT	1
13	NGKBKR6E	09482-00427	SPARK-PLUG	BUJIA	CANDELA	BOUGIE	4
14	REC11318-96J00	11318-96J00	O-RING	TORICA	FASCIA TONDA	TORIQUE	1
15	REC18137-93J00	18137-93J00	SENSOR	SENSOR	SENSORE	CAPTEUR	1
16	REC18590-72F21	18590-72F21	MAP SENSOR	SENSOR MAP	SENSORE MAP	CAPTEUR MAP	1
17	REC11489-96J01	11489-96J01	OIL PAN GASKET	JUNTA CARTER	GUARNIZIONE COPPA	JOINT DE CARTER	1
18	REC09168-12012	09168-12012	OIL DRAIN PLUG GASKET	JUNTA TAPON CARTER	GUARNIZIONE TAPPO	JOINT DE VIDANGE	1
19	REC11552-96J00	11552-96J00	GASKET	JUNTA	GUARNIZIONE	JOINT	1
20	REC17914-93J00	17914-93J00	GASKET	JUNTA	GUARNIZIONE	JOINT	1
21	REC17913-93J00	17913-93J00	WATER FLUSH PLUG	TAPON AGUA	TAPPO ACQUA	BOUCHON DE REFROIDISSEMENT	1
22	REC51124-93J01	51124-93J01	OIL SEAL	RETEN 24X39X6.7	PARAOILIO	JOINT D'HUILE	2
23	REC51123-96J02	51123-96J02	GASKET	JUNTA	GUARNIZIONE	JOINT	1
24	REC51211-96J00	51211-96J00	GASKET	JUNTA	GUARNIZIONE	JOINT	1
25	REC51142-96J00	51142-96J00	GASKET	JUNTA	GUARNIZIONE	JOINT	1



INFO  
SUZUKI  
P. 71

A  
REC11400-96893



INFO  
SUZUKI  
P. 71

B  
REC11410-96811

REC10W30U3  
REC10W30U6  
REC10W40U3  
REC10W40U6

INFO  
INSTAL.  
P. 18

REGREU1  
REGREU12

INFO  
INSTAL.  
P. 20

INFO  
INSTAL.  
P. 32

INFO  
INSTAL.  
P. 33

INFO  
INSTAL.  
P. 36

A DF200, DF225, DF250 (2004-23) B DF250AP, DF300AP (2012+), DF300T/Z (2007-11)

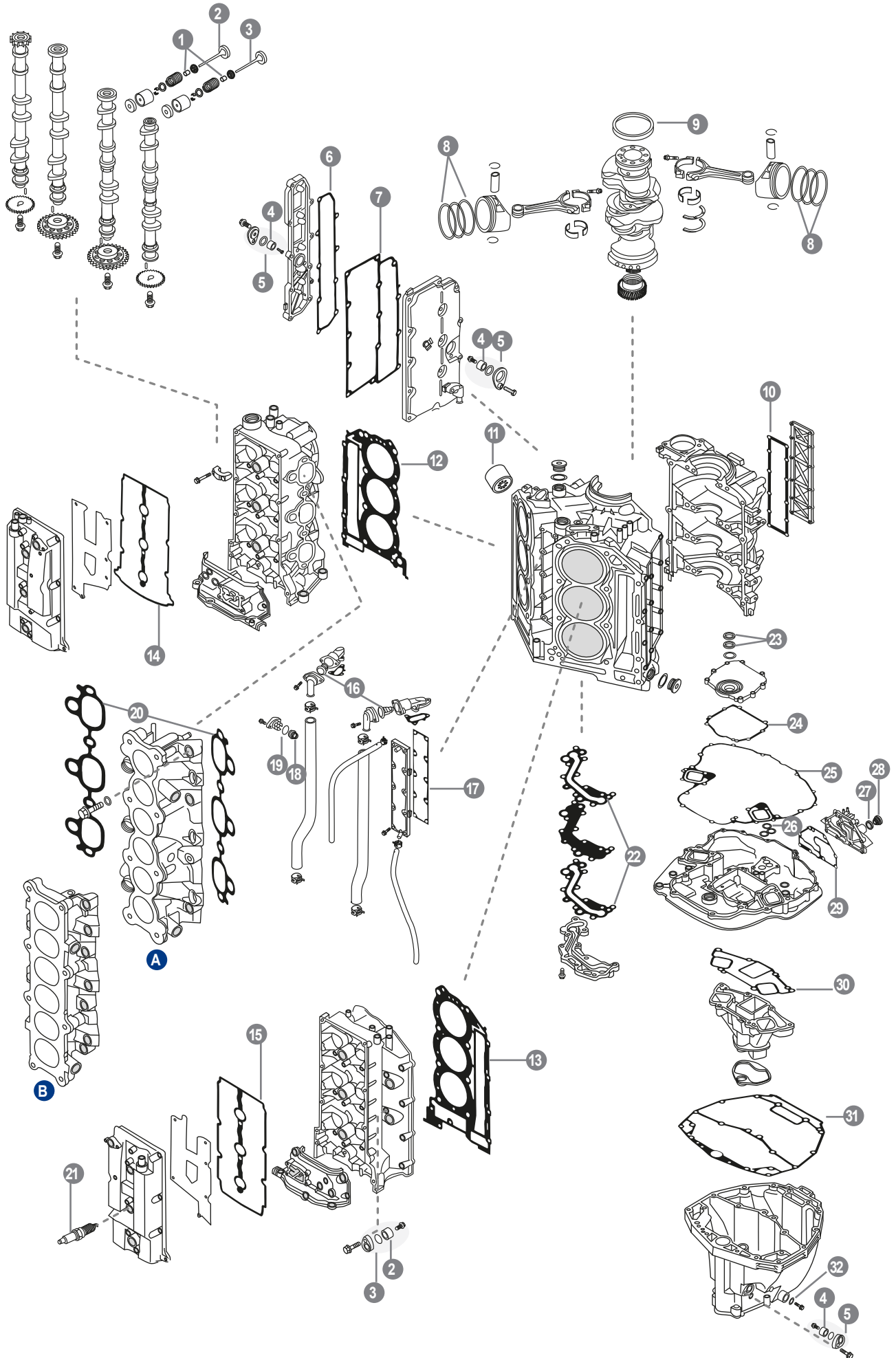

	ref	OEM				UN.	
1	PAF166-010003	09289-05006	SEAL VALVE STEM	RETÉN VÁLVULA	PARAOLIO VALVOLA	JOINT DE QUEUE DE SOUPAPE	12
2	REC12915-93J60	12915-93J60	EXHAUST VALVE 31.5X5.5X92	VALVULA ESCAPE 31.5X5.5X92	VALVOLA DI SCARICO 31.5X5.5X92	SOUPAPE D'ÉCHAP. 31.5X5.5X92	6
3	<b>A</b> REC12911-93J00	12911-93J00	INTAKE VALVE 35.85X5.5X92.1	VALVULA ADMISION 35.85X5.5X92.1	VALVOLA DI ASPIRAZIONE 35.85X5.5X92.1	SOUPAPE D'ADMISSION 35.85X5.5X92.1	6
	<b>B</b> REC12911-98J00	12911-98J00	INTAKE VALVE 38X5.5X92.1	VALVULA ADMISION 38X5.5X92.1	VALVOLA DI ASPIRAZIONE 38X5.5X92.1	SOUPAPE D'ADMISSION 38X5.5X92.1	6
4	REC55321-87J01AL	55321-87J01	ALUMINIUM ANODE	ANODO ALUMINIO	ANODO ALLUMINIO	ANODE ALUMINIUM	4
5	REC11261-93J00	11261-93J00	COVER ANODE ASSY	TAPA ANODO COMPLETA	COPERCHIO ANODO COMPLETO	COUVERCLE COMPLET ANODE	4
6	REC14151-93J00	14151-93J00	GASKET EXHAUST COVER	JUNTA TAPA ESCAPE	GUARNIZIONE COPERCHIO SCARICO	JOINT DE COUVERCLE D'ECHAPPEMENT	1
7	REC14152-93J00	14152-93J00	GASKET EXHAUST COVER	JUNTA TAPA ESCAPE	GUARNIZIONE COPERCHIO SCARICO	JOINT DE COUVERCLE D'ECHAPPEMENT	1
8	<b>A</b> REC12140-93J00	12140-93J00					
	<b>B</b> REC12140-98J10	12140-98J10	RING SET, PISTON STD	AROS DE PISTON STD	FASCE PISTON	KIT DE SEGMENTS	6
9	REC09283-91001	09283-91001	OIL SEAL	RETEN	PARAOLIO	JOINT D'HUILE	1
10	REC11332-93J00	11332-93J00	CYLINDER BLOCK PLATE GASKET	JUNTA TAPA BLOQUE	GUARNIZIONE COPERCHIO BLOCCO	JOINT DE COUVERCLE DE BLOC	1
11	REC16510-93J00	16510-96J11	OIL FILTER	FILTRO ACEITE	FILTRO OLIO	FILTRE A HUILE	1
12	<b>A</b> REC11142-93J10	11142-93J10	CYLINDER HEAD GASKET PORT	JUNTA CULATA BABOR	GUARNIZIONE TESTA BABORDO	JOINT DE CULASSE GAUCHE	1
	<b>B</b> REC11142-98J10	11142-98J10					
13	<b>A</b> REC11141-93J10	11141-93J10	CYLINDER HEAD GASKET STB	JUNTA CULATA ESTRIBOR	GUARNIZIONE TESTA TRIBORDO	JOINT DE CULASSE DROIT	1
	<b>B</b> REC11141-98J10	11141-98J10					
14	REC11189-93J00	11189-93J00	GASKET	JUNTA	GUARNIZIONE	JOINT	1
15	REC11179-93J00	11179-93J00	GASKET	JUNTA	GUARNIZIONE	JOINT	1
16	REC67F-12411-01	17670-90J01	THERMOSTAT 60°	TERMOSTATO 60°	TERMOSTATO 60°C	THERMOSTAT 60°	2
17	REC11272-93J00	11272-93J00	CYLINDER BLOCK PLATE GASKET	JUNTA TAPA BLOQUE	GUARNIZIONE COPERCHIO BLOCCO	JOINT DE COUVERCLE DE BLOC	1
18	REC17660-99E01	17660-99E01	WATER PRESSURE VALVE	VALVULA DE PRESION DE AGUA	VALVOLA DI PRESSIONE DELL'ACQUA	VANNE DE PRESSION D'EAU	1
19	REC09280-26006	09280-26006	O-RING	TÓRICA	FASCIA TONDA	TORIQUE	1
20	<b>A</b> REC13119-93J00	13119-93J00					
	<b>B</b> REC13119-98J00	13119-98J00	GASKET INTAKE MANIFOLD	JUNTA COLECTOR ADMISION	GUARNIZIONE COLLETTORE ASPIRAZIONE	JOINT COLLECTEUR D'ADMISSION	2
21	NGKBR6E	09482-00427	SPARK-PLUG	BUJIA	CANDELA	BOUGIE	6
22	REC16433-93J00	16433-93J00	GASKET OIL GALLERY	JUNTA	GUARNIZIONE	JOINT	2
23	REC51124-93J01	51124-93J01	OIL SEAL 24X39X6.7	RETEN 24X39X6.7	PARAOLIO 24X39X6.7	JOINT D'HUILE 24X39X6.7	2
24	REC51123-93J00	51123-93J00	GASKET MOUNT OIL SEAL COVER	JUNTA BASE RETEN	GUARNIZIONE	JOINT CARTER D'HUILE	1
25	REC51211-93J00	51211-93J00	ENGINE HOLDER GASKET	JUNTA CARTER	GUARNIZIONE COPPA	JOINT DE CARTER	1
26	REC51116-93J01	51116-93J01	SEAL, WATER RETURN	JUNTA RETORNO DE AGUA	GUARNIZIONE, RITORNO ACQUA	JOINT, RETOUR D'EAU	1
27	REC17914-93J00	17914-93J00	GASKET	JUNTA	GUARNIZIONE	JOINT	1
28	REC17913-93J00	17913-93J00	WATER FLUSH PLUG	TAPON AGUA	TAPPO ACQUA	BOUCHON DE REFROIDISSEMENT	1
29	REC51142-93J00	51142-93J00	BASE GASKET	JUNTA BASE	GUARNIZIONE	JOINT DE BASE	1
30	REC14212-93J00	14212-93J00	GASKET EXHAUST COVER	JUNTA TAPA ESCAPE	GUARNIZIONE COPERCHIO SCARICO	JOINT DE COUVERCLE D'ECHAPPEMENT	1
31	REC11489-93J00	11489-93J00	OIL PAN GASKET	JUNTA CARTER	GUARNIZIONE COPPA DELLOLIO	JOINT DE CARTER D'HUILE	1
32	REC09168-12012	09168-12012	OIL DRAIN PLUG GASKET	JUNTA TAPON CARTER	GUARNIZIONE TAPPO	JOINT DE VIDANGE	1

**B**

REC11410-98831

SUZUKI  
P. 71REC10W30U3  
REC10W30U6  
REC10W40U3  
REC10W40U6INSTAL.  
P. 18REGREU1  
REGREU12INSTAL.  
P. 20INSTAL.  
P. 32INSTAL.  
P. 33**LOCTITE**INSTAL.  
P. 36

DF300B, DF325A, DF350A (2018-23)

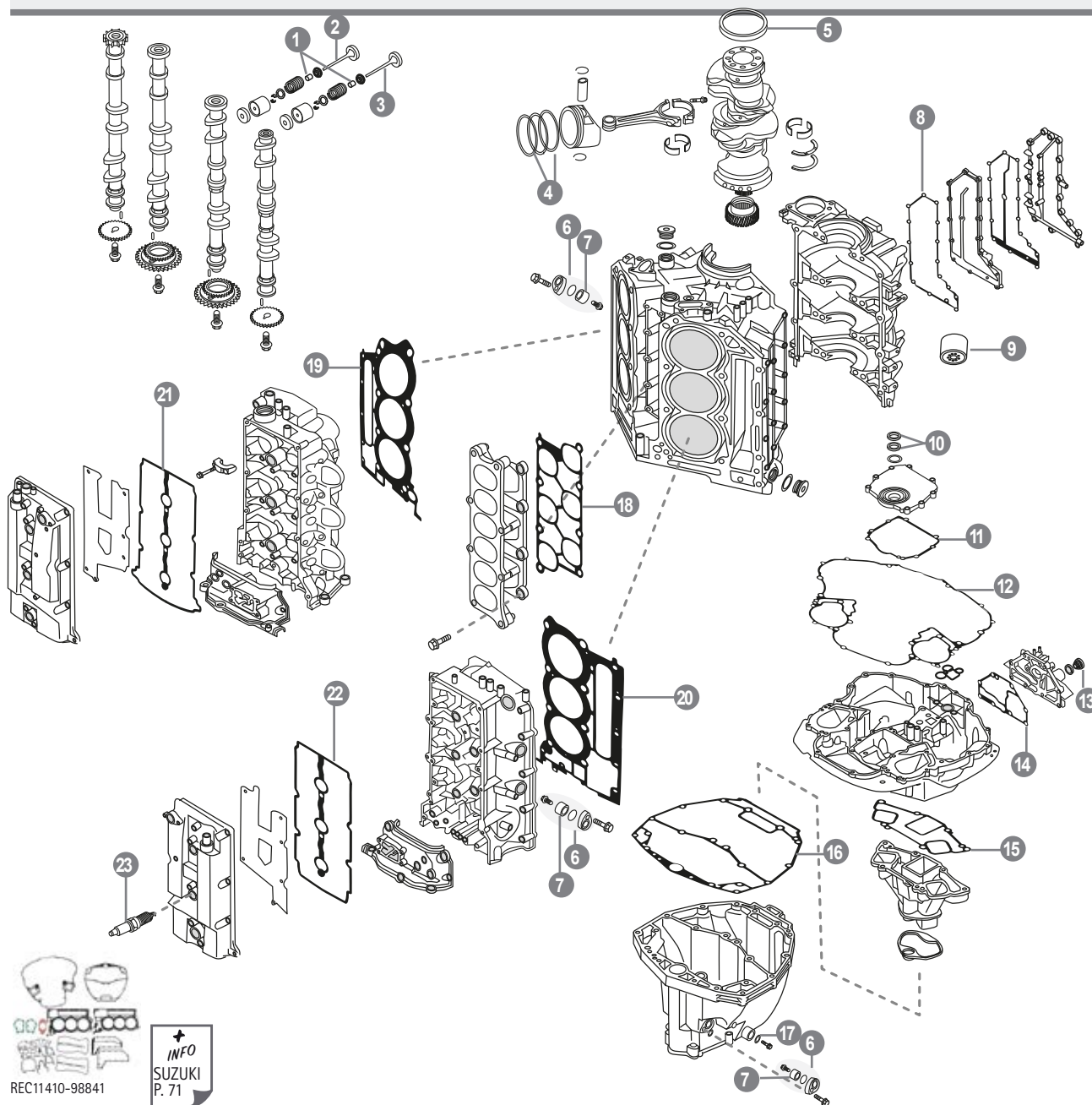

REC11410-98841

+  
 INFO  
 SUZUKI  
 P. 71

REF	OEM				UN.		
1	PAF166-010003	09289-05006	SEAL VALVE STEM	RETÉN VÁLVULA	PARAOILIO VALVOLA	JOINT DE QUEUE DE SOUPAPE	12
2	REC12911-98L00	12911-98L00	INTINTAKE VALVE	VALVULA ADMISION	VALVOLA DI ASPIRAZIONE	SOUPAPE D'ADMISSION	3
3	REC12915-98L00	12915-98L00	EXHAUST VALVE	VALVULA ESCAPE	VALVOLA DI SCARICO	VALVE D'ÉCHAPPEMENT	3
4	REC12140-98J10	12140-98J10	RING SET, PISTON STD	AROS DE PISTON STD	FASCE PISTON	KIT DE SEGMENTS	6
5	REC09283-91001	09283-91001	OIL SEAL	RETEN	PARAOILIO	JOINT D'HUILE	1
6	REC11261-93J00	11261-93J00	COVER ANODE ASSY	TAPA ANODO COMPLETA	COPERCHIO ANODO COMPLETO	COUVERCLE COMPLET ANODE	3
7	REC55321-87J01AL	55321-87J01	ALUMINIUM ANODE	ANODO ALUMINIO	ANODO ALLUMINIO	ANODE ALUMINIUM	3
8	REC11333-98L00	11333-98L00	CYLINDER BLOCK PLATE GASKET	JUNTA TAPA BLOQUE	GUARN. COPERCHIO BLOCCO	JOINT DE COUVERCLE DE BLOC	1
9	REC16510-93J00	16510-96J11	OIL FILTER	FILTRO ACEITE	FILTRO OLIO	FILTRE A HUILE	1
10	REC51124-93J01	51124-93J01	OIL SEAL 24X39X6.7	RETEN 24X39X6.7	PARAOILIO 24X39X6.7	JOINT D'HUILE 24X39X6.7	2
11	REC51123-98L00	51123-98L00	GASKET, OIL SEAL COVER D	JUNTA TAPA ACEITE D	GUARN. COPERCHIO PARAOILIO D	JOINT COUVERCLE D'HUILE D	1
12	REC51211-98L00	51211-98L00	HOUSING GASKET	JUNTA CUERPO	GUARN. DELL'ALLOGGIAMENTO	JOINT DE LOGEMENT	1
13	REC17913-93J00	17913-93J00	WATER FLUSH PLUG	TAPON AGUA	TAPPO ACQUA	BOUCHON REFROIDISSEMENT	1
14	REC51142-98L00	51142-98L00	GASKET,ENGINE HOLDER	JUNTA SOPORTE MOTOR	GUARN. DEL SUPPORTO MOTORE	JOINT DU SUPPORT MOTEUR	1
15	REC12472-98L00	12412-98L00	GASKET	JUNTA	GUARNIZIONE	JOINT	1
16	REC11489-98L00	11489-98L00	GASKET,OIL PAN	JUNTA CARTER	GUARNIZIONE COPPA OLIO	JOINT DE CARTER	1
17	REC09168-12012	09168-12012	OIL DRAIN PLUG GASKET	JUNTA TAPON CARTER	GUARNIZIONE TAPPO	JOINT DE VIDANGE	1
18	REC13119-98L00	13119-98L00	GASKET,INTAKE MANIFOLD	JUNTA COLECTOR ADMIS.	GUARN. COLLETTORE ASPIRAZIONE	JOINT COLLECTEUR D'ADMIS.	1
19	REC11142-98L00	11142-98L00	CYLINDER HEAD GASKET	JUNTA CULATA	GUARNIZIONE TESTA	JOINT DE CULASSE	1
20	REC11141-98L00	11141-98L00	CYLINDER HEAD GASKET	JUNTA CULATA	GUARNIZIONE TESTA	JOINT DE CULASSE	1
21	REC11189-93J00	11189-93J00	GASKET	JUNTA	GUARNIZIONE	JOINT	1
22	REC11179-93J00	11179-93J00	GASKET	JUNTA	GUARNIZIONE	JOINT	1
23	NGKILZKR7D8	09482-000642	SPARK-PLUG	BUJIA	CANDELA	BOUGIE	6

ENGINE GASKET, 4 STROKES

JUNTAS DE MOTOR, 4 TIEMPOS

GUARNIZIONI DE MOTORE 4 TEMPI

JOINTS DE MOTEUR, 4 TEMPS

CYLINDER HEAD GASKET		JUNTAS DE CULATA		GUARNIZIONE DE TESTATA		JOINTS DE CULASSE	
		REF	OEM				
1	DF2.5	(2006+)	REC11141-97J02	11141-97JL0 11141-97J01			1
2	DF4, DF5, DF6	(2002-15)	REC11141-91JL0	11141-91JL0 11141-91J01/02			2
3	DF9.9, DF15T-K DF9.9, DF15 (R) MY04	(1996-03) (2004-11)	REC11141-93E20	11141-93E20			3
4	DF9.9B DF15A, DF20A	(2014+)	REC11141-89L00	11141-89L00			4
5	DF9.9 DF15	(2004-12)	REC11141-94JL0	11141-94JL0 11141-94J00	SUZUKI P. 54		
6	DF20, DF25, DF25R V2 DF25V	(2006-13) (2010-14)	REC11141-95J00	11141-95J00	SUZUKI P. 57		
7	DF25A DF30A	(2015+)	REC11141-94L00	11141-94L00	SUZUKI P. 56		
8	DF40, DF50	(1999-10)	REC11141-87J02	11141-87J00/01/02	SUZUKI P. 58		
9	DF40A, DF50A, DF60A	(2010+)	REC11141-88L00	11141-88L00	SUZUKI P. 59		
10	DF70A DF75A DF80A, DF100B DF90A	(2010-23) (2023) (2009+) (2010-23)	REC11141-87L00	11141-87L00	SUZUKI P. 60		
11	DF90, DF100, DF115K1-K11 DF115	(2001-11) (2010-23)	REC11141-90J01	11141-90J00	SUZUKI P. 61		
12	DF100A, DF115A DF140 DF140A	(2013-21) (2002-12) (2013-21)	REC11141-92J01	11141-92J00/01	SUZUKI P. 62		
13	DF100C DF115B DF115BG/BZG, DF140B DF100C, DF115B	(2022-23) (2022-24) (2021+)	REC11141-99L00	11141-99L00	SUZUKI P. 63		
14	DF140B DF150 DF150T/G/Z, DF175T/G/Z DF175	(2021-23) (2010-18) (2006-18) (2010-18)	REC11141-96J01	11141-96J01	SUZUKI P. 65		
15	DF150AT/AZ, DF175AT/AZ, DF200AT/AZ DF150A, DF175A, DF200A DF150AP, DF175AP, DF200AP DF150AT, DF175AT, DF200AT DF200AT/AZ DF150A, DF175A	(2020-21) (2024+) (2015+) (2019-23) (2018) (2019-23)	REC11141-96L00	11141-96L00	SUZUKI P. 65		

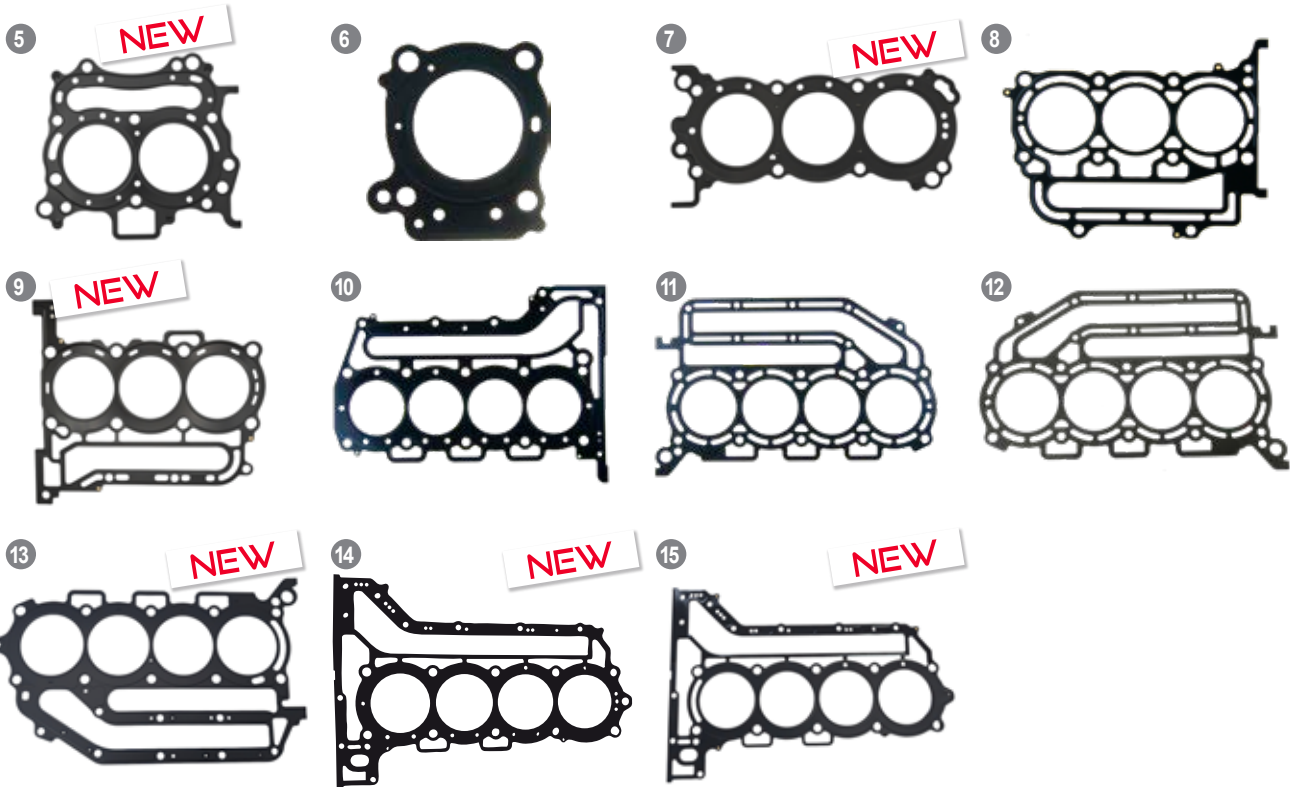

		REF	OEM				
DF200 DF225 DF250	(2010-14) (2010-23) (2010-23)	1 REC11142-93J10	11142-93J03	SUZUKI	PORT	BABOR	BABORDO GAUCHE
		2 REC11141-93J10	11141-93J03	P. 67	STB	ESTRIBOR	TRIBORDO DROIT
DF300 DF300AP	(2010-11) (2012-23)	3 REC11142-98J10	11142-98J00	SUZUKI	PORT	BABOR	BABORDO GAUCHE
DF250AP DF300T-Z	(2013-23) (2007-11)	4 REC11141-98J10	11141-98J00	P. 67	STB	ESTRIBOR	TRIBORDO DROIT
DF300B DF325A/DF350A	(2020-23) (2018-23)	5 REC11142-98L00	11142-98L00	SUZUKI	PORT	BABOR	BABORDO GAUCHE
		6 REC11141-98L00	11141-98L00	P. 68	STB	ESTRIBOR	TRIBORDO DROIT

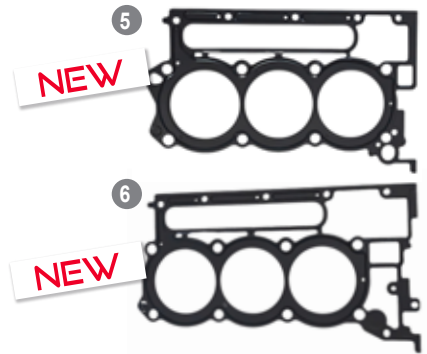
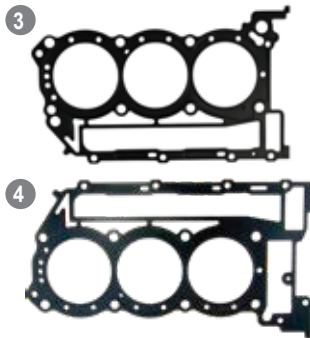
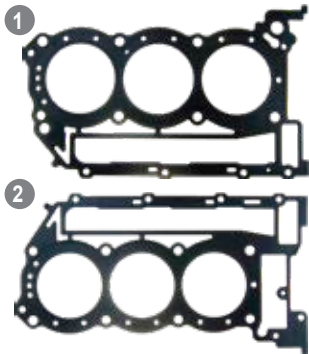

CYLINDER GASKET	JUNTAS BASE DE MOTOR	GUARNIZIONE BASE MOTORE	JOINTS DE TÊTE MOTRICE
-----------------	----------------------	-------------------------	------------------------

		REF	OEM	
1 DF9,9B DF20A, DF15A	(2013+) (2013-23)	REC51211-89L00	51211-89L00	SUZUKI P. 55
2 DF15	(2010-12)	REC11489-93E11	11489-93E11	SUZUKI P. 54
3 DF25A, DF30A	(2015-23)	REC51211-94L00	51211-94L00	SUZUKI P. 70
4 DF25V	(2010-14)	REC11489-95J01	11489-95J01	SUZUKI P. 57
5 DF40A DF50A, DF60A	(2011-23) (2010-23)	REC51211-88L00	51211-88L00	SUZUKI P. 59
6 DF40, DF50	(1999-10)	REC51211-87J00	51211-87J00	SUZUKI P. 58
7 DF70A DF75A DF80A, DF90A, DF100B	(2010-23) (2023) (2010-23)	REC51211-87L10	51211-87L00/10	SUZUKI P. 60
8 Old engines   Motores antiguos Motore vecchio   Moteurs anciennes DF115 DF140	(2010-12) (2010-11)	REC51211-90J10	51211-90J00/01/02/10	SUZUKI P. 61
9 DF90, DF100, DF115, DF100A, DF115A, DF140A DF140 DF140A	(2013+) (2012) (2013-21)	REC51211-90J2	51211-90J21/22	SUZUKI P. 62
10 DF100C, DF115B, DF140B DF150 DF150A DF140B	2022-23 2010-18 2019-23 2022-23	REC51211-90J30	51211-90J30	SUZUKI P. 63
11 DF150A, DF175A, DF200A DF150T/G/Z, DF175T/G/Z DF175 DF200A	(2015+) (2006-18) (2010-23) (2015-23)	REC51211-96J00	51211-96J00	SUZUKI P. 65
12 DF200A DF200, DF225, DF250 DF300AP DF300T/Z	(2004-15) (2012-23) (2007-11)	REC51211-93J00	51211-93J00	SUZUKI P. 67
13 DF200 DF225, DF250 DF250AP DF300 DF300B, DF350A DF325A, DF350A	(2010-14) 2010-23 2013-23 (2010-11) (2018-23) (2018+)	REC51211-98L00	51211-98L00	SUZUKI P. 68

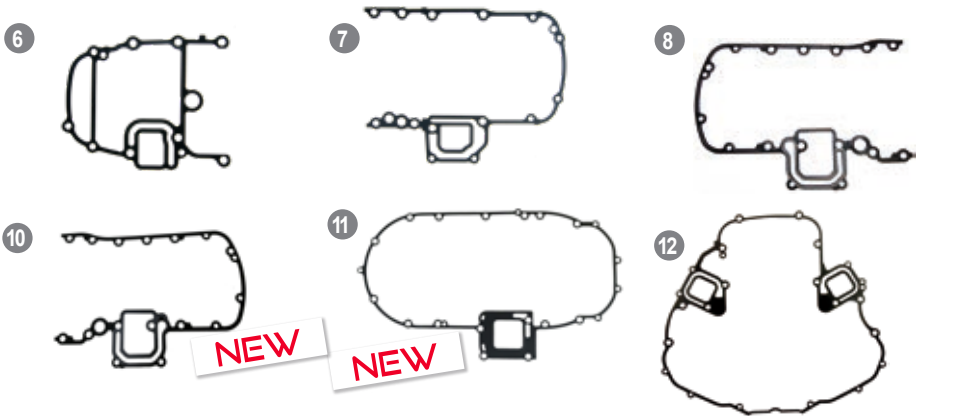
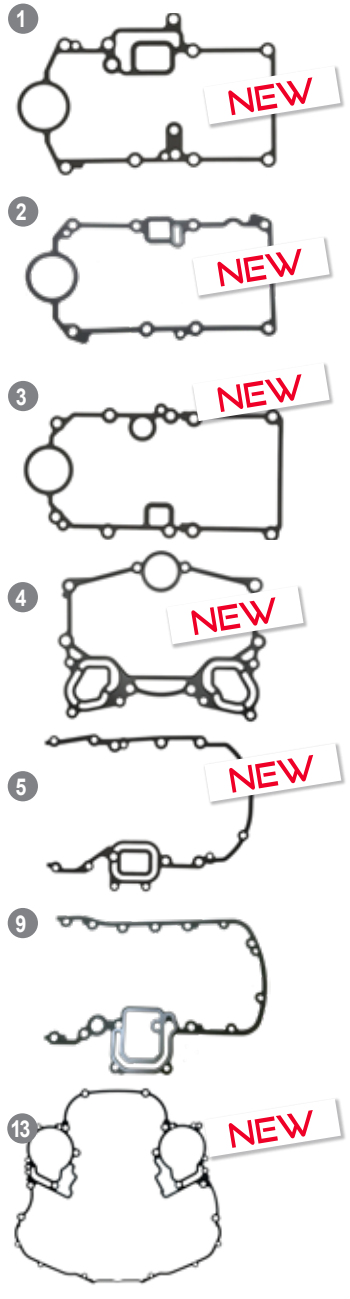

CYLINDER HEAD GASKET, KIT

KITS JUNTAS DE CULATA

KIT GUARNIZIONE TESTATA

KITS JOINTS DE CULASSE

REF	OEM	
1 REC11410-93835	11410-93832/3/5	DT9.9, DT15 DT9.9K, DT15K G-Y (2001-04) (1986-00)
2 REC11400-96883	11400-96880/1/2/3 11400-96869	DT20, DT25, DT30 DT25, DT30 K1-K2 (2001-02) (2006-14)
3 REC11410-95811	11410-95811	DF20R TWIN DF25V TWIN DF25V (2010-14)
4 REC11400-88872	11400-88870/1/2	DF40A, DF50A DF60A (2011-23) (2010-23)
5 REC11400-87804	11400-87800/1/2/3/4	DF40, DF50 (1999-10)
6 REC11410-94826	11410-94820/1/3/6/7	DT40 (2010-23) (2023)
7 REC11410-87851	11410-87850/1	DF70A, DF90A DF75A (2013-21) (2011-12)
8 REC11400-92863	11400-92860/1/2/3	DF100A, DF115A, DF140A DF115 (2013-21) DF115A (2002-12) DF140 (2012-12)

REF	OEM	
9 REC11410-90823	11410-90820/1/2/3	DF115 (2010)
10 REC11400-96893	11400-96892/93	DF150T/Z/G, DF175T/Z/G DF150, DF175 (2006-18) (2010-18)
11 REC11410-96811	11410-96811	DF150/175/200 AT/AP/AZ DF150A, DF175A (2019+) (2019-23)
12 REC11410-93872	11410-93870/71/72	DF200A DF200 (2010-14) DF225, DF250 (2010-23) (2013-23)
13 REC11410-98831	11410-99830/31	DF250AP DF300 (2010-11) DF300AP (2012-23)
14 REC11410-98841	11410-98840/41	DF300B DF325A DF350A (2020-23) (2018-23)

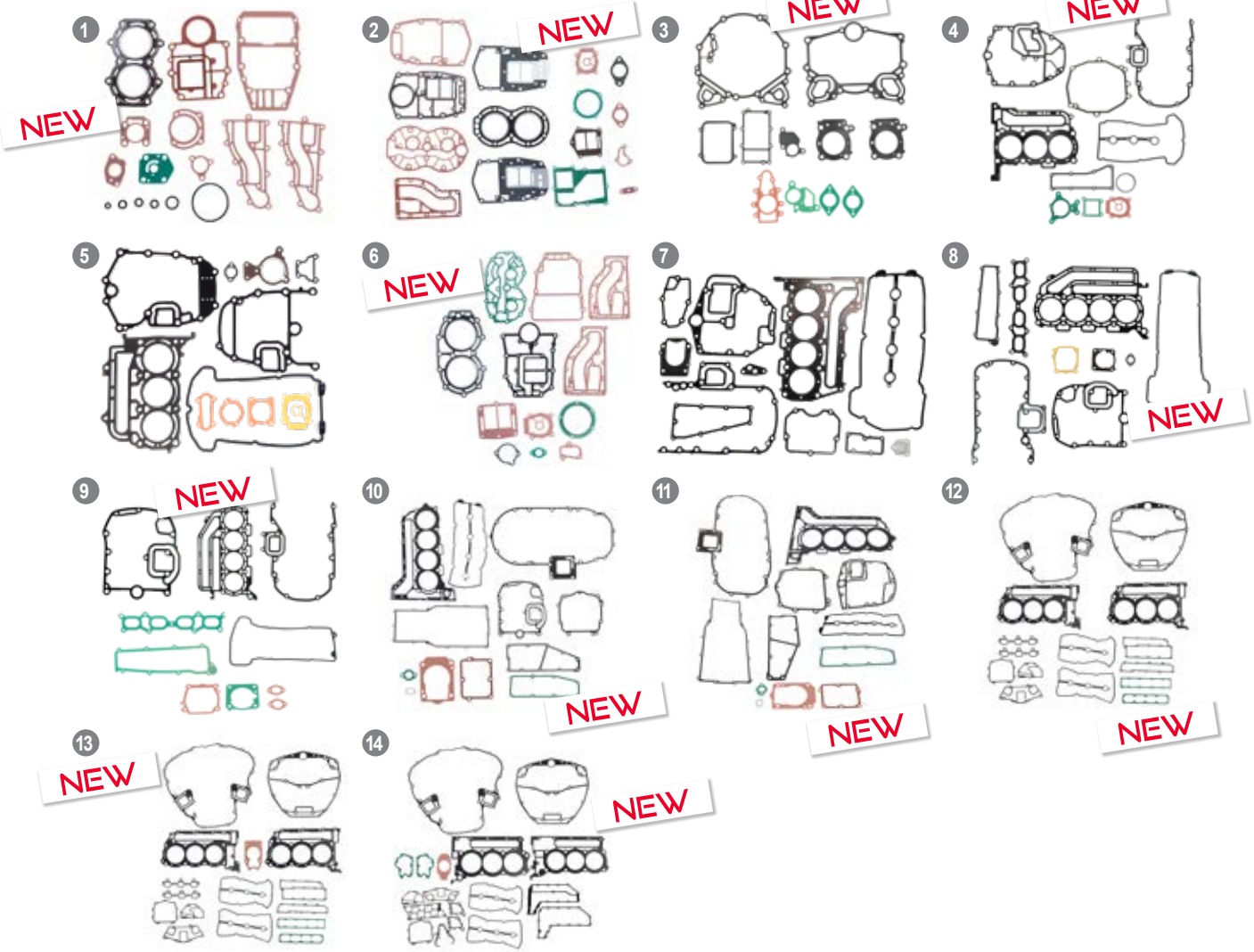

GASKET, UNDER OIL

JUNTAS BASE ACEITE

GUARNIZIONE BASE OLIO

JOINTS BASE D'HUILE

REF	OEM	
1 REC51142-93J00	51142-93J00	DF200, DF225, DF250 DF300AP (2004+) DF300T-Z (2012) (2007-11)
2 REC51142-96J00	51142-96J00	DF150, DF175, DF200 T/1/AP (2006+)
3 REC51142-98L00	51142-98L00	DF300B, DF325A, DF350A (2018+)

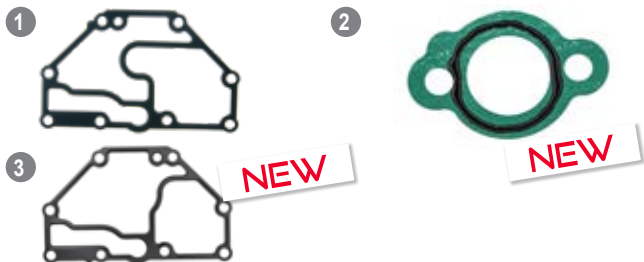

MOUNT OIL SEAL COVER		JUNTAS BASE RETÉN	
REF	OEM		
1 REC51123-88L00	51123-88L00	DF40A/DF50A/DF60A	(2010+)
2 REC51123-87L00	51123-87L00	DF70A, DF80A, DF90A, DF100B	(2009+)
3 REC51123-96J02	51123-96J01/2	DF150A, DF175A, DF200A DF150T/G/Z, DF175T/G/Z	(2015+) (2006-18) (2004+)
4 REC51123-93J00	51123-93J00	DF300AP DF300T/Z	(2012) (2007-11)
5 REC51123-98L00	51123-98L00	DF300B, DF325A, DF350A	(2018+)

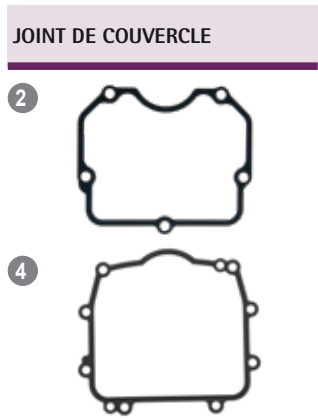
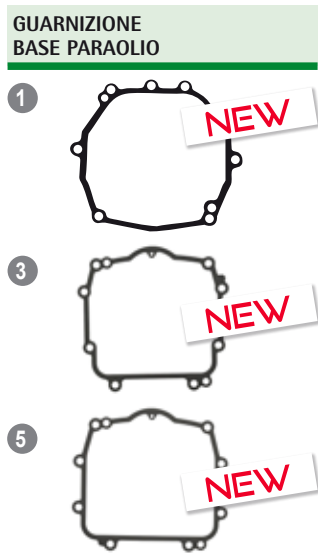

GASKET, OIL GALLERY		JUNTAS ACEITE	
REF	OEM		
1 REC17693-95J00	17693-95J00	DF20R, DF25, DF25R V2	(2006-11)
2 REC11318-96J00	11318-96J00	DF150A/DF175A/DF200A DF150T/Z-DF175T/Z	(2017+) (2006+)
3 REC16433-93J00	16433-93J00	DF200, DF225, DF250 DF300AP DF300T/Z	(2004+) (2012) (2007-11)



GASKET, TIMING CHAIN GUIDE BASE		JUNTAS GUÍA CADENA	
REF	OEM		
REC12778-93J00	12778-93J00	DF200, DF225, DF250 DF300AP DF300T/Z	(2004+) (2012) (2007-11)

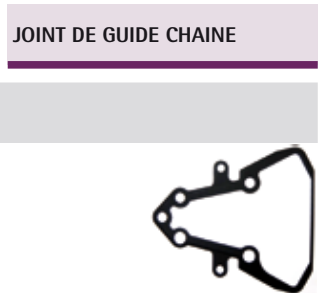
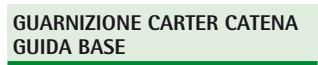

GASKET, FILTER COVER		JUNTA TAPA DE FILTRO	
REF	OEM		
REC16539-87L00	16539-87L00	DF70A, DF80A, DF90A, DF100B	(2009+)



GASKET, THROTTLE BODY		JUNTAS CUERPO DE MARIPOSA	
REF	OEM		
1 REC13421-87J00	13421-87J00	DF40, DF50	
2 REC13421-90J02	13421-90J02	DF90, DF100, DF115 DF100A, DF115A, DF140A DF100C, DF115B, DF140B	(2001-11) (2013+) (2022+)
3 REC13421-98J00	13421-98J00	DF140 DF300AP (2012) DF300T/Z (2007-11)	(2002-12)

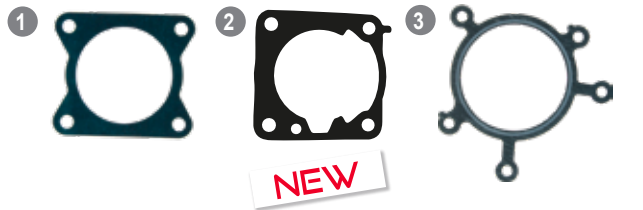
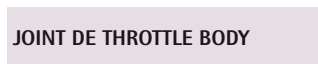
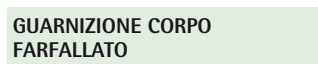

GASKET, COVER		JUNTA TAPA	
REF	OEM		
<b>NEW</b>			
1 REC11189-95J00	11189-95J00	DF20R, DF25, DF25R V2	(2006-13)
2 REC11189-87J00	11189-87J00	DF40, DF50	(1999-10)
3 REC11189-88L00	11189-88L00	DF40A, DF50A, DF60A	(2010+)
4 REC11189-87L00	11189-87L00	DF70A, DF80A, DF90A, DF100B	(2009+)
5 REC11189-90J00	11189-90J00	DF90, DF100, DF115 DF100A, DF115A, DF140A DF100C DF115B DF140 DF140B	(2001-11) (2013-21) (2023) (2021+) (2002-12) (2021+)
6 REC11189-96J00	11189-96J00	DF150A, DF175A, DF200A DF150T/G/Z, DF175T/G/Z	(2015+) (2006-18)
7 REC11342-96J00	11342-96J00	DF150A, DF175A, DF200A DF150T/G/, DF175T/G/Z	(2015+) (2006-18)
8 REC11332-96J00	11332-96J00	DF150A, DF175A, DF200A DF150T/G/Z, DF175T/G/Z	(2015+) (2006-18)
9 REC11189-93J00	11189-93J00	DF200, DF225, DF250 DF250AP, DF300AP DF300B, DF325A, DF350A DF300T/Z	(2004+) (2015+) (2018+) (2007-11)
10 REC11179-93J00	11179-93J00	DF200, DF225, DF250 DF250AP, DF300AP DF300B, DF325A, DF350A DF300T/Z	(2004+) (2015+) (2018+) (2007-11)
11 REC11332-93J00	11332-93J00	DF200, DF225, DF250 DF300T/Z (A)	(2004+) (2007+)

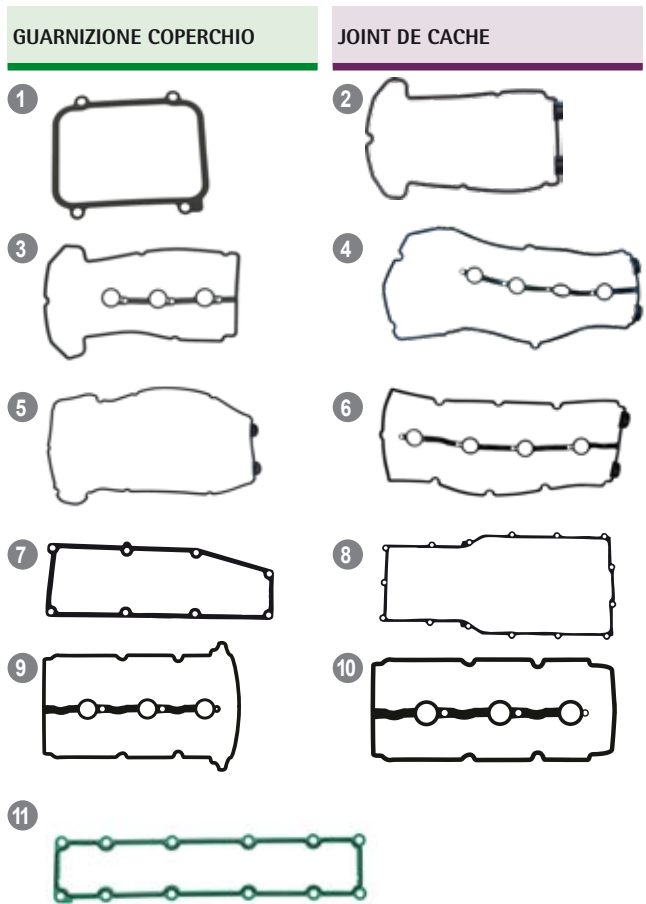

GASKET, PRESSURE VALVE		JUNTA VÁLVULA DE PRESIÓN	
REF	OEM		
			
REC17616-87J00	17616-87J00	DF40, DF50	(1999-10)



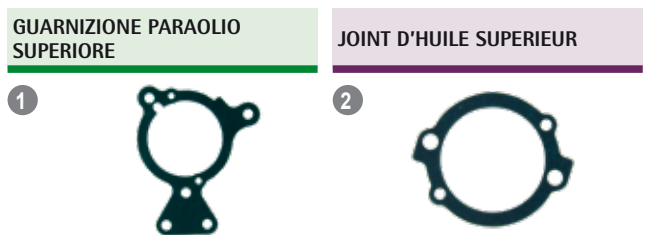

GASKET, UPPER SEAL		JUNTA RETÉN SUPERIOR	
REF	OEM		
			
1 REC11413-87J00	11413-87J00	DF40, DF50	(1999-10)
2 REC11433-87J00	11433-87J00	DF40, DF50	(1999-10)

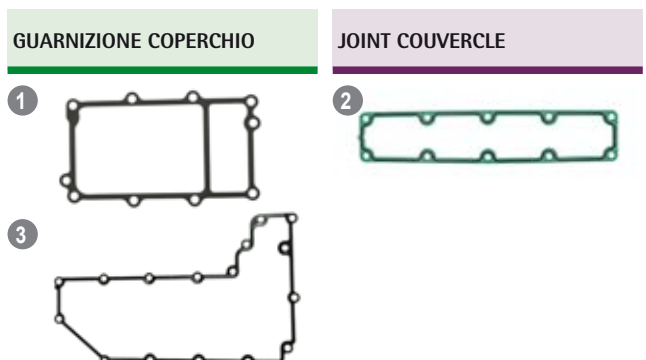

COVER GASKET		JUNTA TAPA DE BLOQUE	
REF	OEM		
<b>NEW</b>			
1 REC11219-95J01	11219-95J01	DF20R, DF25, DF25R V2	(2006-13)
2 REC11272-93J00	11272-93J00	DF200, DF225, DF250 DF250A, DF300AP DF300T/Z	(2004+) (2015+) (2007-11)
3 REC11333-98L00	11333-98L00	DF300B, DF325A, DF350A	(2018+)

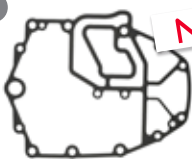
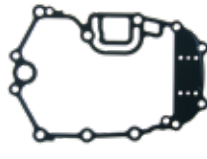
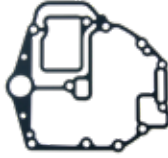
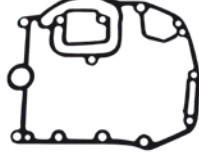
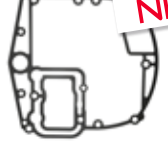
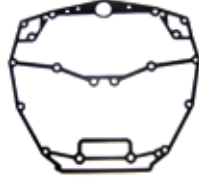

GASKET, OIL PAN		JUNTA CÁRTER		GUARNIZIONE COPPA L'OLIO		JOINT DU CARTER	
REF	OEM						
1 REC11489-93E11	11489-93E11	DF9.9, DF15	(2004-12)	1 	NEW	2 	
2 REC11489-88L01	11489-88L01	DF40A, DF50A, DF60A	(2010+)				
3 REC11489-87J00	11489-87J00	DF40, DF50	(1999-10)				
4 REC11489-87L00	11489-87L00	DF70A, DF80A, DF90A, DF100B	(2009+)				
5 REC11489-90J00	11489-90J00	DF90, DF100, DF115 K1-K11 DF100A, DF115A 7, DF140 DF115WT, DF140WT-K3 DF140	(2001-11) (2013+) (2003) (2002-12)	3 		4 	
6 REC11489-96J01	11489-96J01	DF150A, DF175A, DF200A DF150T/G/Z, DF175T/G/Z	(2015+) (2006-18)				
7 REC11489-93J00	11489-93J00	DF200, DF225, DF250 DF300AP DF300T/Z	(2004+) (2012) (2007-11)	5 	NEW	6 	
8 REC11489-98L00	11489-98L00	DF300B, DF325A, DF350A	(2018+)	7 	NEW		

BLOCK GASKET		JUNTA DE BLOQUE		GUARNIZIONE BLOCCO		JOINT DU BLOC	
REF	OEM						
REC11351-95J01	11351-95J01	DF20R, DF25, DF25R V2	(2006-13)			NEW 	



3

## CAMSHAFT

## ÁRBOL DE LEVAS

## ALBERO A CAMME

## ARBRE A CAMES

REF	OEM				
REC12710-97J00	12710-97J00	DF2.5	(2006+)		



4

CRANKSHAFT

CIGÜEÑAL

ALBERO MOTORE

VILEBREQUIN

CRANKSHAFT SPROCKET		PIÑON CADENA DISTRIBUCION	PIGNONE DELL'ALBERO MOTORE	PIGNON DE VILEBREQUIN
REF	OEM			
REC12730-96J01	12730-96J00/1	DF150T/Z, DF175T/Z (2006-13) DF150/175/200 AT/AZ (2014+) DF150AP, DF175AP, DF200AP (2017+) DF200A (2015-18)		 <b>NEW</b>

OIL SEAL, CRAKSHAFT	RETÉN DE ACEITE CIGÜEÑAL	PARAOLIO ALBERO MOTORE	JOINT SPI, VILEBREQUIN
---------------------	--------------------------	------------------------	------------------------

		<b>NEW</b>	A	OEM		B	OEM			
	DF15	(2010-12)	<b>1</b>	REC09283-32048	09283-32048	32 x 44 x 6.5 mm	<b>1</b>	REC09283-32048	09283-32048	32 x 44 x 6.5 mm
	DF15A, DF20A	(2013-23)								
	DF25A, DF30A	(2015-23)	<b>2</b>	REC09283-38025	09283-38025	38 x 56 x 7 mm	<b>3</b>	REC09283-34014	09283-34014	34 x 46 x 8 mm
	DF20R, DF25, DF25R V2	(2006-13)								
	DF25V	(2010-14)	<b>3</b>	REC09283-34014	09283-34014	34 x 46 x 8 mm				
	DF20R, DF25, DF25R V2	(2006-13)	<b>4</b>	REC09283-35047	09283-35047	35 x 47 x 6 mm	<b>11</b>	REC12281-87J00	12281-87J00	29.3 x 44 x 7 mm
	DF40, DF50	X-K10(1999-10)	<b>5</b>	REC09283-37005	09283-37005	37 x 49 x 6 mm	<b>11</b>	REC12281-87J00	12281-87J00	29.3 x 44 x 7 mm
	DF40A, DF50A	(2011-23)								
	DF60A	(2010-23)								
	DF60, DF70	W-K9 (1998-09)	<b>6</b>	REC09283-52004	09283-52004	52 x 66 x 10 mm				
	DF70A, DF80A, DF90A	(2009-18)								
	DF90, DF100, DF115	(2001-11)								
	DF140, DF140A	(2002-13)								
	DF100A, DF115A, DF140A	(2013-15)								
	DF115	(2010-12)								
	DF140A	(2013-21)								
	DF70A, DF80A, DF90A, DF100B	(2016-23)								
	DF75A	(2023)	<b>7</b>	REC09283-52006	09283-52006	52 x 70 x 10 mm				
	DF100A, DF115A, DF140A	(2017-21)								
	DF100C	(2023)								
	DF115BG/BZG	(2021-22)								
	DF140B, DF115B	(2022-24)								
	DF140BG/BGZ	(2021-23)								
	DF90, DF100, DF115	(2001-11)								
	DF100A, DF115A, DF140A	(2013-21)	<b>8</b>	REC09282-24003	09282-24003	24 x 36 x 6 mm	<b>8</b>	REC09282-24003	09282-24003	24 x 36 x 6 mm
	DF100C	(2023)								
	DF115BG/BZG	(2021-22)								
	DT115, DT140 G-Y	(1986-00)								
	DF140/A	(2002-13)								
	DF140B, DF115B	(2021-24)								
	DF150T/Z, DF175T/Z	(2006-11)								
	DF200, DF225, DF250	(2004-11)								
	DF300T/Z	(2007-11)								
	DF150	(2011-18)								
	DF150A	(2019-23)	<b>9</b>	REC51124-93J01	51124-93J00/1	30 x 47 x 7 mm	<b>9</b>	REC51124-93J01	51124-93J00/1	30 x 47 x 7 mm
	DF175	(2012-18)								
	DF175A	(2019-23)								
	DF200	(2010-14)								
	DF200A	(2015-23)								
	DF225, DF250	(2010-23)								
	DF250AP	(2013-23)								
	DF300	(2010-11)								
	DF300AP	(2012-23)								
	DF300B	(2020-23)								
	DF350A	(2018-23)								
	DF150, DF175	(2010-18)								
	DF150A, DF175A	(2019-23)								
	DF200	(2010-14)								
	DF200A	(2015-23)								
	DF225, DF250	(2010-23)	<b>10</b>	REC09283-91001	09283-91001	91 x 109 x 10 mm	<b>10</b>	REC09283-91001	09283-91001	91 x 109 x 10 mm
	DF250AP	(2013-23)								
	DF300	(2010-11)								
	DF300AP	(2012-23)								
	DF300B	(2020-23)								
	DF350A	(2018-23)								



5

VALVES

VÁLVULAS

VALVOLE

SOUPAPES

GUIDE, VALVES	GUÍA DE VÁLVULAS	GUIDA VALVOLE	GUIDE DES SOUPAPES				
	INTAKE ADMISIÓN ASPIRAZIONE ADMISSION	OEM	EXHAUST ESCAPE SCARICO ÉCHAPPEMENT				
DF40A, DF50A, DF60A DF100A, DF115A, DF140A DF100C DF115BG/BZG DF140B, DF115B DF150AP, DF175AP, DF200AP DF150T(G)/Z, DF175T(G)/Z DF200, DF225, DF250 DF250AP, DF300AP DF300T/Z DF150, DF175, DF200 AT/AZ DF150A, DF175A, DF200A DF150AP, DF175AP, DF200AP DF200, DF225, DF250 DF200A DF250AP, DF300AP DF300T/Z DF300B, DF325A, DF350A	(2010+) (2019-21) (2023) (2021-29) (2021+) (2015+) (2006-18) (2004+) (2012+) (2007-11) (2020-21) (2024+) (2018+) (2021+) (2015-17) (2013-23) (2007-11) (2018+)	REC12911-88L00 REC12911-86FA2 REC12911-93J00 REC12911-98J00 REC12911-98L00	2911-88L00 2911-86FA2 2911-93J00 2911-98J00 2911-98L00	26,6X5,5X80,2 33X6X86,2 35,85X5,5X92,1 38X5,5X92,1 37,85X5,5X92,8	REC12915-73G20 REC12915-86FA1 REC12915-93J60 REC12915-93J60 REC12915-98L00	2915-73G20 2915-86FA1 2915-93J60 2915-93J60 2915-98L00	21,5X5,5X81,3 28X6X86 31,5X5,5X92 31,5X5,5X92 31,5X5,5X93,1

OIL SEAL, VALVES	RETÉN DE VÁLVULA	PARAOLIO VALVOLA	JOINT SPI, SOUPAPE
NEW		1	2
REF	OEM		3
1 REC09289-05008	09289-05008	DF8A/AR, DF9.9A/AR DF25A, DF30A DF15 DF15A, DF20A DF25V DF40, DF50 DF40A, DF50A DF60A, DF70A, DF90A DF75A 2023	(2012+) (2015-23) (2010-12) (2013-23) (2010-14) (2010) (2011-23) (2010-23) (2010-23)
2 PAF166-010003	09289-05006/12 09289-05L04	DF150, DF175 DF150A, DF175A DF200 DF200A DF225, DF250 DF250AP DF300 DF300AP DF300B DF350A	(2010-18) (2019-23) (2010-14) (2015-23) (2010-23) (2013-23) (2010-11) (2012-23) (2020-23) (2018-23)
3 REC09289-06003	09289-06003	DF90, DF100, DF115 DF100A, DF115A, DF140A DF100C DF115BG/BZG DF115 DF115A DF115B DF140 DF140A DF140B	(2001-11) (2013-21) (2023) (2021-22) (2010-12) (2013-21) (2022-23) (2010-12) (2002-21) (2022-23)



6

FLY WHEEL

VOLANTE

VOLANTE

VOLANT

FLYWHEEL LOCK NUT	TUERCA VOLANTE MOTOR	DADO DE VOLANTE	ECROU DE VOLANT
REF	OEM		
REC09140-14008	09140-14008	DF15 DF25A, DF30A DF8A/AR, DF9.9A/AR DF9.9B, DF15A, DF20A DT9.9, DT15	R T-K3 (1996-12) (2015+) (2012+) (2014+) K G-Y K1-K4 (1986-04)

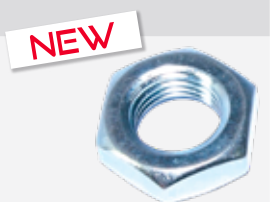

## PISTONS

## PISTON KITS

The Recmar® piston assortment is always supplied as a set (piston, rings, pins and bearings). Old references may change. In case of any doubt contact our technicians.

## PISTONES

## KITS DE PISTONES

La gama de pistones Recmar®, se suministrará siempre como kit, compuesto por pistón, aros, bulón y clips. Eventualmente las referencias antiguas sufren cambios de numeración. En caso de duda contactar con nuestros técnicos comerciales.

## PISTONI

## KIT PISTONE

La gamma dei pistoni Recmar®, si vende sempre come kit, composto da pistoni, fasce, bulloni e clips. Le referenze vecchie avranno un cambio di numerazione. In caso di dubbi contattare i nostri tecnici commerciali.

## PISTONS

## KIT PISTON

La gamme de pistons RECMAR® sera toujours fournie en kit, comprenant piston, segments, axe et clips. Les anciennes références subissent des modifications de numérotation. En cas de doute, contactez nos technico commerciaux

STD					
REF	OEM				
REC12111-97J10	17111-97J10-0B0	DF2.5	(2006+)		

## PISTON RINGS KITS

## KITS DE AROS

## SET FASCE

## KIT SEGMENTS

STD				STD			
REF	OEM			REF	OEM		
REC12140-97J00	12140-97J00	DF2.5	(2006+)	REC12140-96J10	12140-96J10	DF150A	(2020-23)
REC12140-89L20	12140-89L20	DF5, DF5, DF6	(2017+)			DF175A	(2019-23)
REC12140-91J10	12140-91J10	DF4, DF5, DF6	(2002-15)			DF200A	(2015-23)
REC12140-02C10	12140-02C10	DF15	(2010-12)	REC12140-93J00	12140-93J00	DF200	(2010-14)
			(2013-15)			DF225	(2010-23)
REC12140-89L00	12140-89L00	DF15A	(2013-15)			DF250	(2010-23)
		DF20A	(2013-14)	REC12140-98J10	R12140-98J10	DF250AP	(2013-23)
		DF25A	(2015-20)			DF300	(2010-11)
		DF30A	(2015-23)			DF300AP	(2012-23)
REC12140-89L10	12140-89L10	DF15A	(2016-23)			DF300B	(2020-23)
		DF20A	(2015-23)			DF350A	(2018-23)
		DF25A	(2021-23)				
REC12140-75F30	12140-75F30	DF25V	(2010-11, 2014)				
REC12140-87J01	12140-87J01	DF40, DF50	(2010)				
REC12140-88L01	12140-88L01	DF40A, DF50A	(2011-23)				
		DF60A	(2010-23)				
		DF70A	(2010-23)				
REC12140-87L01	12140-87L01	DF75A	(2023)				
		DF90A	(2010-23)				
REC12140-86FA0	12140-86FA0	DF115	(2010-12)				
		DF115A	(2013-23)				
REC12140-92J10	12140-92J10	DF140	(2010-12)				
		DF140A	(2013-23)				
		DF150	(2010-18)				
REC12140-96J00	12140-96J00	DF150A	(2019)				
		DF175	(2010-18)				



## GUIDE, TIMING BELT

## TIMING BELT GUIDE

		REF	OEM
DF8A/AR, DF9.9A/AR	(2010+)	66	1 REC12761-99J00 12761-99J00
DF15	(2012)		
DF9.9, DF15T-K3	(1996-03)	69	2 REC12761-93E00 12761-93E00
DF9.9, DF15 R	(2004-11)		
DF9.9B, DF15A	(2013+)		
DF60, DF70 W-K9	(1998-09)	89	3 REC12761-72F00 12761-72F00
DF25A, DF30A	(2015+)		4 REC12761-94L10 12761-94L00/10

## GUÍA CORREAS DE DISTRIBUCIÓN

## GUÍA CORREAS DE DISTRIBUCIÓN

## GUIDA CINGHIE DISTRIBUZIONE

## GUIDA CINGHIE DISTRIBUZIONE

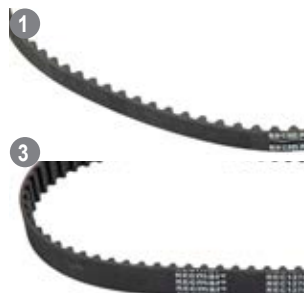

## GUIDE DES COURROIES DE DISTRIBUTION

## GUIDE DES COURROIES DE DISTRIBUTION

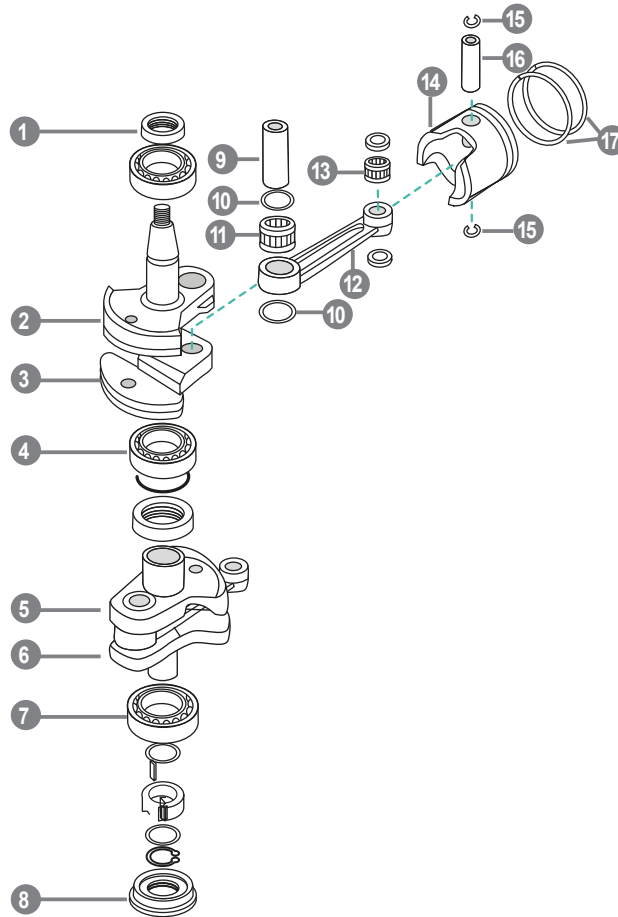

**2 STROKES**
**2 TIEMPOS**
**2 TEMPI**
**2 TEMPS**

 DT40C-W-G-X (1986-99)  
 DTW-K1-KA (2001-04)

	REF	OEM					UN.
1	REC09283-35043	09283-35043	OIL SEAL	RETÉN	PARAOLIO	JOINT SPI	1
2	REC12221-94412	12221-94412	CRANKSHAFT 1	CIGÜEÑAL 1	ALBERO MOTORE 1	VILEBREQUIN 1	1
3	REC12231-94413	12231-94413	CRANKSHAFT 2	CIGÜEÑAL 2	ALBERO MOTORE 2	VILEBREQUIN 2	1
4	REC09269-30012	09269-30012	BEARING	RODAMIENTO	CUSCINETTO	ROULEMENT	1
5	REC12232-94412	12232-94412	CRANKSHAFT 3	CIGÜEÑAL 3	ALBERO MOTORE 3	VILEBREQUIN 3	1
6	REC12240-94432	12240-94432	CRANKSHAFT 4	CIGÜEÑAL 4	ALBERO MOTORE 4	VILEBREQUIN 4	1
7	REC09262-35052	09262-35052	BEARING	RODAMIENTO	CUSCINETTO	ROULEMENT	1
8	REC09283-30062	09283-30062	OIL SEAL	RETÉN	PARAOLIO	JOINT SPI	1
9	REC12211-94410	12211-94410	PIN CRANK	BULON CIGÜEÑAL	SPINOTTO	CLAVETTE	2
10	REC09160-27008	09160-27008	WASHER	ARANDELA	RONDELLA	RONDELLE	4
11	REC09263-27005	09263-27005	ROD BEARING	COJINETE BIELA	CUSCINETTO BIELLA	ROULEMENT DE BIELLE	2
12	REC12161-94400	12161-94400	CONNECTING ROD	BIELA	BIELLA	BIELLE	2
13	REC09263-20072	09263-20072	ROD BEARING	COJINETE BIELA	CUSCINETTO BIELLA	ROULEMENT DE BIELLE	2
14	REC12110-94400K	12110-94400K	PISTON KIT	KIT PISTON	KIT PISTONE	KIT PISTON	2
15	REC09381-20003	09381-20003	CNAP RING	CLIP	CLIP	CLIP	4
16	REC12151-94400	12151-94400	PIN	PIN	SPINA	AXE DE PISTON	2
17	REC12140-94400	12140-94400	RING SET	KIT SEGMENTOS	SET FASCE	KIT DE SEGMENTS	2

10

## ENGINE GASKET, 2 STROKES

## JUNTAS DE MOTOR, 2 TIEMPOS

## GUARNIZIONI DE MOTORE 2 TEMPI

## JOINTS DE MOTEUR, 2 TEMPS

## CYLINDER HEAD GASKET

## JUNTAS DE CULATA

## GUARNIZIONE DE TESTATA

## JOINTS DE CULASSE

	REF	OEM		
1	REC11141-98401	11141-98401		DT2, DT2.2 G-Y (1986-00)
2	REC11141-98130	11141-98130		DT5, DT6, DT8 G-Y (1986-00) DT6, DT8 Y-KS (2000-02)
3	REC11141-93960	11141-93950		DT9.9D, DT15K-G-Y (1986-00) DT9.9, DT15K1-K4 (2001-04) DT15C (1989-97)
4	REC11141-96303	11141-96344		DT20, DT25, DT30G-Y (1986-00)
5	REC11141-95D40	11141-95D40		DT25C, DT30C-K-Y (1989-00)
6	REC11141-96344	11141-96344		DT25, DT30 K1-K2 (2001-02)

	REF	OEM		
7	REC11141-87E90	11141-87E90/20		DT25, DT30 C-K-Y (1989-00)
8	REC11141-94450	11141-94450		DT40C-W-G-X (1986-99)
9	REC11141-94720	11141-94701/20		DT55, DT65J-X (1988-99)
10	REC11141-95505	11141-95505		DT75, DT85J-Y (1983-00)
11	REC11141-87D90	11141-87D90/61		DT90, DT100L-Y (1990-00)
12	REC11141-94506	11141-94506/20		DT115, DT140G-Y (1986-00) 4 In line

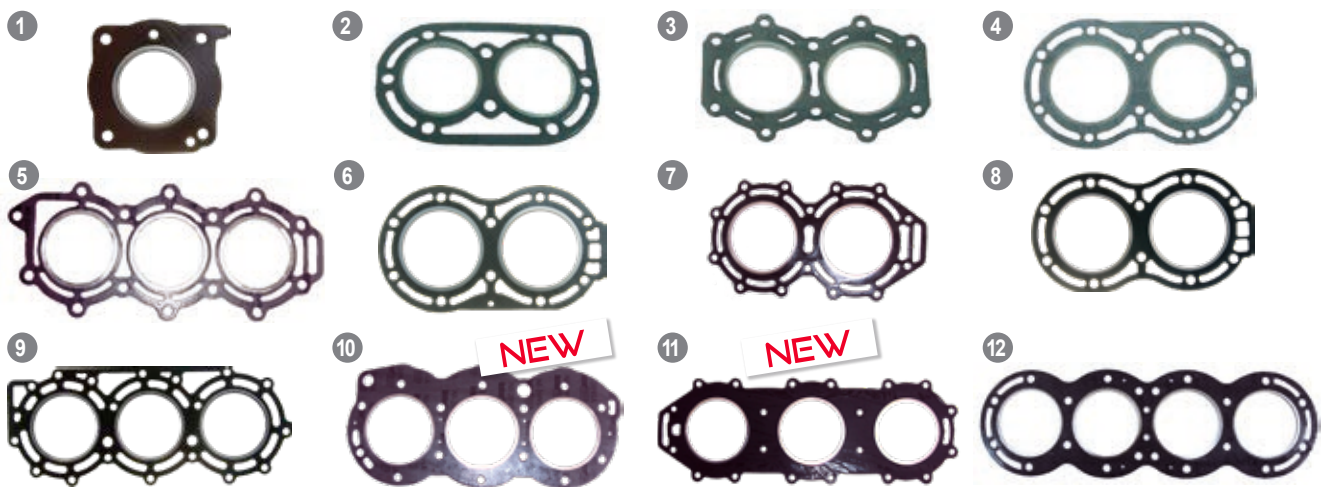

## CYLINDER HEAD GASKET GUIDE

## GUÍA JUNTAS DE CULATA

## GUIDA GUARNIZIONE TESTA

## GUIDE JOINTS DE CULASSE

		REF	OEM
	DT2.2, DT2.2 G-Y	1986-00	REC11141-98401 11141-98411
	DT5, DT6, DT8 G-Y	1986-00	REC11141-98130 11141-98130
	DT6, DT8 Y-K2	2000-02	REC11141-98130 11141-98130
	DT9.9K, DT15 K-G-Y	1986-00	REC11141-93960 11141-93950
	DT9.9, DT15 K1-K4	2001-04	REC11141-93960 11141-93950
	DT15C	1989-97	REC11141-93960 11141-93950
	DT20, DT25, DT30 G-Y	1986-00	REC11141-96303 11141-96344
	DT25, DT30 C-K-Y	1989-00	REC11141-95D40 11141-95D40

		REF	OEM
	DT25, DT30 K1-K2	2001-01	REC11141-96344 11141-96343
	DT40 C-W-G-X	1986-99	REC11141-94450 11141-94440
	DT55, DT65 J-X	1988-99	REC11141-94720 11141-94720
	DT75, DT85 J-Y	1988-00	REC11141-95505 11141-95621
	DT90, DT100 L-Y	1990-00	REC11141-87E90 11141-87E20
	DT115, DT140 G-Y	1986-00	REC11141-94506 11141-94620
	DT150, DT200, V6	1986-86	REC11141-87D90 11141-87D61

## GASKET, HEAD COVER

## JUNTAS DE CULATÍN

## GUARNIZIONI COPERCHIO TESTATA

## JOINT DE COUVRE CULASSE

REF	OEM		
REC11162-94410	11162-94410	DT40C-WG-X DT40W K1-K4	(1986-99) (2001-04) SUZUKI P. 79

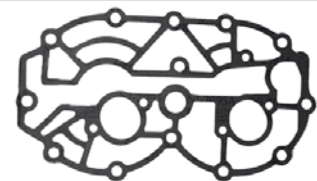

**GASKET, UNDER OIL**
**JUNTAS BASE ACEITE**
**GUARNIZIONE BASE OLIO**
**JOINTS DE TÊTE MOTRICE**

REF	OEM	
1 REC11433-93912	11433-93901	DT9.9, DT15 K1-K4 (2001-04) DT9.9K, DT15K-G-Y (1986-00)
2 REC11433-94412	11433-94401	DT40C-W-G-X (1986-00)
3 REC11433-96330	11433-96302	DT20, DT25, DT30G-Y (1986-00) DT25, DT30 K1-K2 (2001-02)

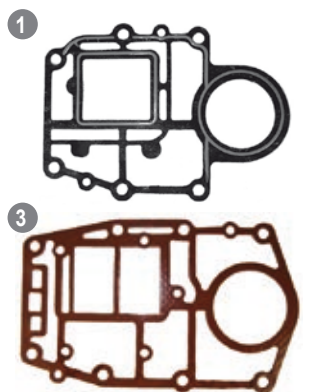
**11**
**CRANKSHAFT**
**CIGÜEÑAL**
**ALBERO MOTORE**
**VILEBREQUIN**
**CRANKSHAFT PARTS**
**PARTES DE CIGÜEÑAL**
**PARTE ALBERO MOTORE**
**PARTS DE VILEBREQUIN**

REF	OEM	
1 REC12221-94412	12221-94412	
2 REC12231-94413	12231-94413	
3 REC12232-94412	12232-94412	DT40C-W-G-X (1986-99) DTW-K1-K4 (2001-04)
4 REC12240-94432	12240-94432	

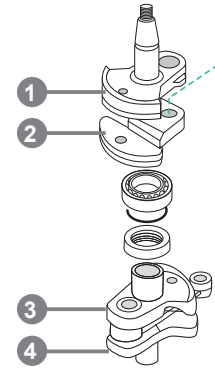
**CRANKSHAFT BEARINGS**
**RODAMIENTOS DE CIGÜEÑAL**
**CUSCINETTI ALBERO MOTORE**
**ROULEMENTS VILEBREQUIN**

REF	OEM		
1 REC09262-25078	09262-25078	DT9.9K, DT15K-G-Y (1986-00) DT9.9, DT15K1-K4 (2001-04)	25 x 25 x 15 mm
2 REC09262-30055	09262-30055	DT20, DT25, DT30G-Y (1986-00) DT75, DT85J-Y (2001-04)	30 x 72 x 19 mm
3 REC09269-30012	09269-30012	DT40X-W-G-X (1988-00) DT40WK1-K4 (1986-99) DT55, DT65J-X (2001-04) DT75, DT85J-Y (1988-99)	30 x 72 x 19 mm

**CONNECTING ROD**
**BIELAS**
**BIELLA**
**BIELLE**

REF	OEM	
1 REC12161-93902	12161-93902	DT9.9K, DT15K-G-Y (1986-00) DT9.9, DT15K1-K4 (2001-04) DT15C (1989-97)
2 REC12161-94400	12161-94400	DT40C-W-G-Y (1986-99) DT40W K1-K4 (2001-04) DT55, DT65J-X (1988-99)

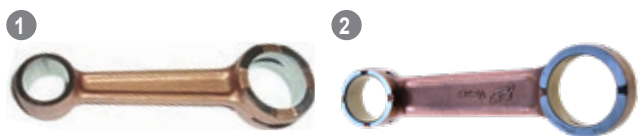

**CONNECTING ROD, THRUST WASHER**
**ARANDELAS DE BIELA**
**RONDELLE BIELLA**
**RONDELLE DE BIELLE**

REF	OEM	
1 REC09160-20052	09160-20052	DT15C (1989-97) DT9.9, DT15K1-K4 (2001-04) DT9.9K, DT15K-G-Y (1986-00)
2 REC09160-27008	09160-27008	DT35 (1987-89) DT40 (1986-98) DT55, DT65 (1985-97)

**CONNECTING ROD, BEARINGS**
**COJINETES DE BIELA**
**CUSCINETTI BIELLA**
**ROULEMENTS DE BIELLE**

	A	OEM	B	OEM
DT9.9K, DT15K G-Y (1986-00) DT9.9, DT15K1-K4 (2001-04) DT15C (1989-97)	1 REC09263-14022	09263-14022	5 REC09263-20051	09263-20051
DT25, DT30 (1983-88)	2 REC09263-18016	09263-14022		
DF20 (1986-88) DT25 (1983-88) DT30 (1983-85) DT40 (1984-85) DT50 (1984+)	3 REC09263-24018	09263-24018		
DT40C-W-G-X (1986-99) DT40W K1-K4 (2001-04) DT55, DT65J-X (1988-99) DT90, DT100L-Y (1990-00)	4 REC09263-20072	09263-20072	6 REC09263-27005	09263-27005

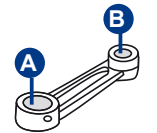
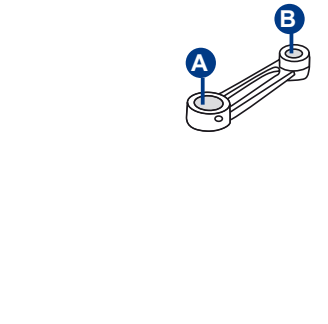
**12**
**PISTON**
**PISTONES**
**PISTONE**
**PISTONS**
**PISTON KITS**
**KITS DE PISTONES**
**KIT PISTONE**
**KIT PISTON**

The Recmar® piston assortment is always supplied as a set (piston, rings, pins and bearings). Old references may change. In case of any doubt contact our technicians.

La gama de pistones Recmar®, se suministrará siempre como kit, compuesto por pistón, aros, bulón y clips. Eventualmente las referencias antiguas sufren cambios de numeración. En caso de duda contactar con nuestros técnicos comerciales.

La gamma dei pistoni Recmar®, si vende sempre come kit, composto da pistoni, fasce, bulloni e clips. Le referenze vecchie avranno un cambio di numerazione. In caso di dubbi contattare i nostri tecnici commerciali.

La gamme de pistons RECMAR® sera toujours fournie en kit, comprenant piston, segments, axe et clips. Les anciennes références subissent des modifications de numérotation. En cas de doute, contactez nos technico commerciaux

	STD	
REF	OEM	
1  REC12110-93130K	12110-93130	DT9.9, DT15K-G-Y (1986-00) DT9.9, DT15K1-K4 (2001-04)
REC12140-93121	12140-93121	
REC09263-14022	09263-14014	
2  REC12110-94350K	12110-94350	DT35 (1980-82) DT40 (1980-82)
3  REC12110-94400K	12110-94400K	
REC12140-94400	12140-94400	DT40C-W-G-X (1986-99) DT40W-K1-K4 (2001-04)
REC09263-20072	09263-20072	

**PISTON RINGS KITS**
**KITS DE ARO**
**KIT FASCE**
**KIT SEGMENTS**

NEW	REF	OEM	
	REC12140-99603	12140-99603	DT4, DT5, DT6, DT8 (1986-02)
	REC12140-93121	12140-93121	DT9.9, DT15 K G-Y (1986-00)
	REC12140-94400	12140-94400	DT40C-W G-X (1986-04)
	REC12140-96361	12140-96361	DT25, DT20, DT30 (1986-02)

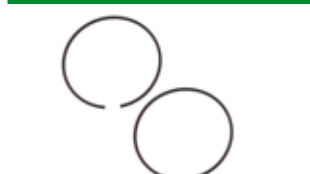

OIL SEAL

RETÉN DE ACEITE

PARAOLIO

JOINT SPI

OIL SEAL		RETÉN DE ACEITE		PARAOLIO		JOINT SPI	
REF	OEM						
1	REC09282-10008	09282-10008	DF2.5 DF4, DF5, DF6	(2006-13) (2002+)	DT4/J4, DT5Y DT4K1	(1988-02) (2001)	10 x 21 x 4.5 mm
2	REC09282-12008	09282-12008	DF2.5 DF4, DF5, DF6	(2012) (2002-12)	DTK1 DT4, J4, DT5Y DT8, DT9.9C-J-V	(1988-02) (2001)	12 x 24 x 4.5 mm
3	REC09283-17002	09283-17002			DT2, DT2.2G-Y DT2.2 K1-K5	(1988-00) (1989-97)	17 x 29 x 7 mm
4	REC09289-10005	09289-10005			DT2, DT2.2G-Y DT2.2 K1-K5	(1986-00) (2001-05)	10 x 26 x 8 mm
5	REC09289-12002	09289-12002			DT2, DT2.2 G-Y DT2.2 K1-K5	(1986-00) (2001-05)	12 x 28 x 8 mm
6	REC09283-25076	09283-25075	DF4, DF5, DF6	(2002+)			25 x 45 x 5 mm
7	REC09283-20045	09283-20045			DT4 -J4, DT5Y DT5Y	(1988-00) (1998-02)	20 x 47 x 8 mm
8	REC09283-20018	09283-20018			DT4K1 DT4K1	(2001) (2001)	
8	REC09283-20018	09283-20018			DT4, J4, DT5Y DT8, DT9.9C-J-V DT15C	(1988-02) (1988-97) (1989-97)	20 x 37 x 9 mm
9	REC09283-10009	09283-10009	DF4, DF5, DF6	(2002+)			10 x 45 x 5 mm
10	REC09283-10003	09283-10003			DT4 J4, DT5Y DT4K1	(1988-02) (2001)	10 x 22 x 6 mm
10	REC09283-10003	09283-10003			DT5, DT6, DT8G-Y DT6, DT8Y-K2	(1986-00) (2000-02)	
11	REC09283-21009	09283-21009	DF4, DF5, DF6 DF8A/AR, DF9.9/AR	(2017+) (2010+)			19.7 x 33 x 6 mm
12	REC09283-30075	09283-30075	DF8A/AR, DF9.9/AR	(2010+)			
13	REC09283-25035	09283-25035			DT9.9K, DT15K-G-Y DT9.9, DT15K1-K4 DT15C	(1986-00) (2001-04) (1989-97)	25 x 40 x 7 mm
14	REC09282-12010	09282-12010	DF9.9, DF15 (R) DF9.9, DF15T-K3	(2004-12) (1996-03)	DT15C DT9.9K, DT15K-G-Y DT9.9, DT15K1-K4	(1986-00) (1989-97)	12 x 25 x 7 mm
15	REC09283-25075	09283-25075			DT9.9K, DT15K-G-Y DT9.9, DT15K1-K4	(1986-00) (2001-04)	25 x 52 x 7 mm
16	REC09289-30008	09289-30008			DT9.9K, DT15K-G-Y DT9.9, DT15K1-K4	(1986-00) (2001-04)	30 x 52 x 10 mm
17	REC09289-12003	09289-12003	DF9.9, DF15T-K3 DF9.9, DF15(R) DF15	(1996-03) (2004-11) (2012)	DT9.9, DT15 K1-K4 DT9.9K, DT15K G-Y DT15C	(2001-04) (1986-00) (1989-97)	13 x 26 x 10 mm
18	REC09282-17006	09282-17006	DF15, DF30 Y-K6 DF15A, DF30A DF20R, DF25, DF25RV2	(2000-06) (2015+) (2006-13)	DT25C, DT30C K-Y	(1989-00)	
19	REC09283-30064	09283-30064			DT20, DT25, DT30G-Y DT25, DT30K1-K2	(1986-00) (2001-02)	30 x 55 x 10 mm
20	REC09282-15008	09282-15008	DF20R, DF25, DF25RVZ	(2006-11)	DT20, DT25, DT30G-Y DT25, DT301-K2	(1986-00) (2001-02)	14.7 x 25 x 6.5 mm
21	REC09289-20009	09289-20009	DF20R, DF25, DF25RVZ DF25, DF30Y-K6	(2006-11) (2000-06)	DT20, DT25, DT30G-Y DT25, DT30K1-K2 DT25C, DT30C-K-Y	(1986-00) (2001-02) (1989-00)	20 x 34 x 6,5 mm





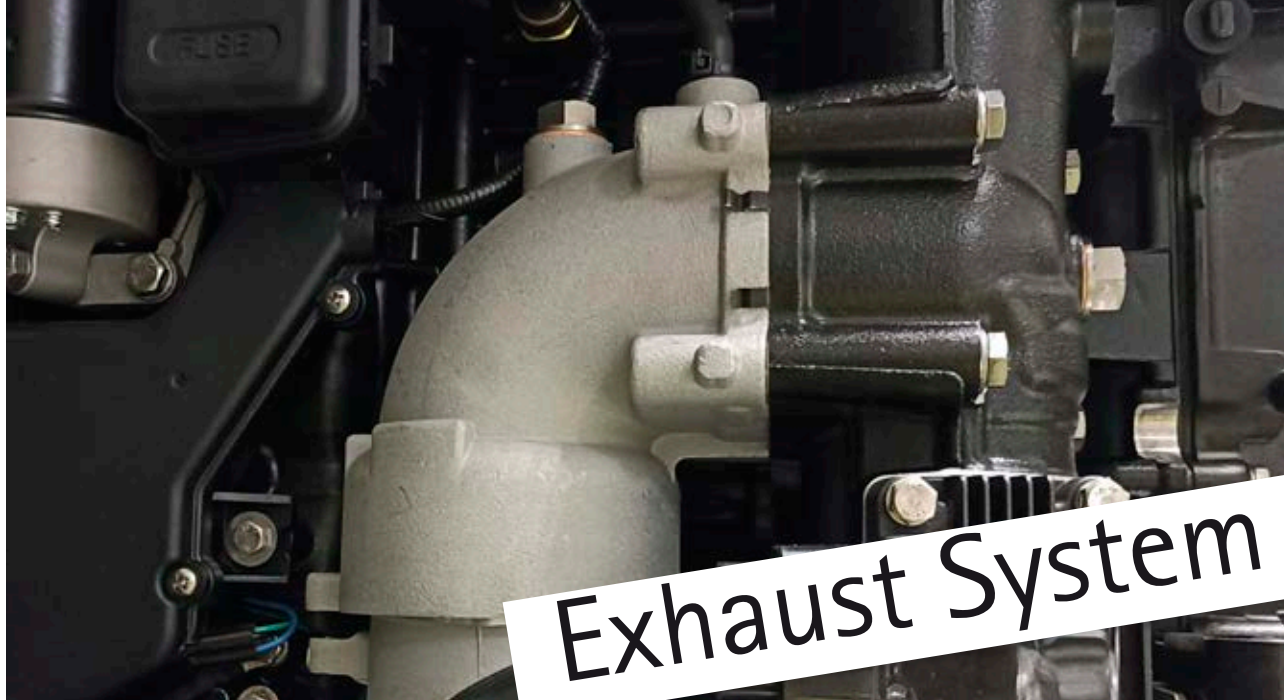

# Exhaust System

EXHAUST SYSTEM

SISTEMA DE ESCAPE

SISTEMA DI SCARICO

SYSTÈME  
D'ÉCHAPPEMENT

1

4

## GASKETS 4 STROKES

## JUNTAS 4 TIEMPOS

## GUARNIZIONI 4 TEMPI

## JOINTS 4 TEMPS

## EXHAUST GASKET

## JUNTAS DE ESCAPE

## GUARNIZIONE DI SCARICO

## JOINTS D'ÉCHAPPEMENT

REF	OEM		
1 REC14151-88L00	14151-88L00	DF40A/DF50A/DF60A	(2010+)
2 REC14151-87L00	14151-87L00	DF70A, DF80A, DF90A, DF100B	(2009+)
3 REC14151-90J00	14151-90J00	DF90, DF100, DF115 DF100A/C, DF115A, DF140A	
4 REC14151-96J00	14151-96J00	DF150A/DF175A, DF200A DF150T/G/Z, DF175T/G/Z	(2015+) (2006-18)
5 REC14151-93J00	14151-93J00	DF200/225/250/300 TZ/A/AP	(2004+)
6 REC14212-93J00	14212-93J00	DF200, DF225, DF250 DF300AP DF300T/Z	(2004+) (2012) (2007-11)
7 REC14212-98L00	14212-98L00	DF300B, DF325A, DF350A	(2018+)

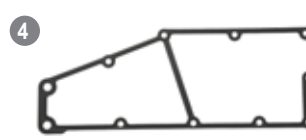

## GASKET, COLLECTOR

## JUNTAS COLECTOR

## GUARNIZIONE COLLETORE

## JOINT DE COLLECTEUR

REF	OEM		
REC13147-98J00	13147-98J00	DF300AP DF300T/Z	(2012) (2007-11)

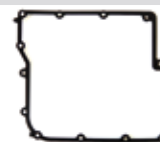

## MULTI EXHAUST GASKET

## JUNTA MÚLTIPLE DE ESCAPE

GUARNIZIONE SCARICO  
MULTIPLIO

## JOINT DE PIPE D'ÉCHAPPEMENT

REF	OEM		
REC11542-87L00	11542-87L00	DF70A, DF80A, DF90A, DF100B	(2009+)



## GASKETS 2 STROKES

## JUNTAS 2 TIEMPOS

## GUARNIZIONI 2 TEMPI

## JOINTS 2 TEMPS

## GASKET, EXHAUST

## JUNTAS DE ESCAPE

## GUARNIZIONE SCARICO

## JOINTS D'ECHAPPEMENT

REF	OEM		
1 REC14151-93912	14151-93901		DT9.9, DT15 K1-K4 (2001-04) DT9.9K, DT15K-G-Y (1986-00)
2 REC52113-93910	52113-93901		DT9.9, DT15 K1-K4 (2001-04) DT9.9K, DT15K-G-Y (1986-00)
3 REC14212-91L00	14212-91L00		DT20, DT25, DT30 G-Y (1986-00)
	14212-96310		DT25, DT30 K1-K2 (2001-02)
4 REC52113-96330	52113-96304		DT20, DT25, DT30G-Y (1986-00) DT25, DT30K1-K4 (2001-02)
5 REC14151-96311	14151-96310		DT20, DT25, DT30G-Y (1986-00) DT25, DT30 K1-K2 (2001-02)
6 REC14212-94413	14212-94412		DT40C-W-G-X (1986-99)
7 REC14151-94411	14151-94412		DT40C-W-G-X (1986-99) DT40W K1-K4 (2001-04)
8 REC11434-94411	11434-94411		DT40C-W-G-X (1986-99) DT40W K1-K4 (2001-04)

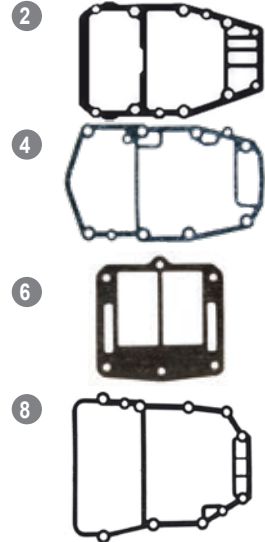
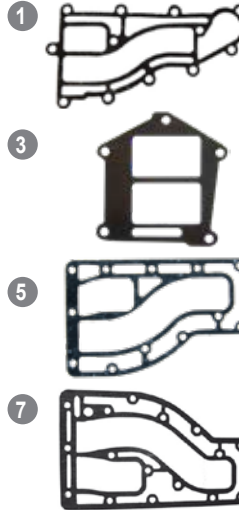

## GASKET, EXHAUST COVER

## JUNTAS TAPA DE ESCAPE

## GUARNIZIONE COPERTURA SCARICO

## JOINTS DE PLAQUE D'ECHAPPEMENT

REF	OEM		
REC14141-93952-0EP	14141-93952-0EP		DT9.9, DT15 K1-K4 (2001-04) DT9.9K, DT15K G-Y (1986-00)





# Intake System

INTAKE SYSTEM

SISTEMA DE ADMISIÓN

SISTEMA DI  
ASPIRAZIONE

SYSTÈME D'ADMISSION

1

4

GASKETS 4 STROKES

JUNTAS 4 TIEMPOS

GUARNIZIONI 4 TEMPI

JOINTS 4 TEMPS

GASKET		JUNTAS		GUARNIZIONE		JOINT	
REF	OEM						
1	REC13122-95J00	13122-95J00	DF20R, DF25, DF25R V2	(2006 -13)	1		
2	REC13119-90J00	13119-90J00	DF90, DF100, DF115 DF100A, DF115A, DF140A DF140	(2001-11) (2013-21) (2002-12)	2		NEW
3	REC13119-93J00	13119-93J00	DF200, DF225, DF250	(2004+)	3		
4	REC13119-98J00	13119-98J00	DF200, DF225, DF250 DF250AP - DF300AP DF300T/Z	(2020+) (2015+) (2007-11)	4		NEW
5	REC13119-98L00	13119-98L00	DF300B, DF325A, DF350A	(2018+)	5		NEW

2

2

GASKETS 2 STROKES

JUNTAS 2 TIEMPOS

GUARNIZIONI 2 TEMPI

JOINTS 2 TEMPS

GASKET		JUNTAS		GUARNIZIONE		JOINT	
REF	OEM						
REC13855-95210	13855-95200/10	DT40 DT40 DT55, DT65 DT75, DT85 DT115, DT140	C-W G-X W K1-K4 J-X J-Y G-Y	(1986-99) (2001-04) (1988-99) (1988-00) (1986-00)			NEW

# Transmission System

UNIT DRIVES &  
COMPONENTS

UNIDADES DE  
TRANSMISIÓN

UNITÀ DI TRASMISSIONE EMBASES ET PIECES

1

4

COMPLETE GEARCASE,  
4 STROKES

COLA COMPLETA, 4  
TIEMPOS

PIEDI COMPLETI, 4  
TEMPI

EMBASE COMPLETE, 4  
TEMPS

GEARCASE

COLAS

PIEDI

EMBASES

	REF	OEM	shaft	ROT.	Gears.	RATIO	
1	REC521-B25F	50040-93839-OEP 50040-93840-OEP	X 25"	Std	12/22	2.29	DF200, DF225, DF250 (2004-16)
2	REC521-B30F	50060-93839-OEP 50060-93840-OEP	X 30"	Std	12/22	2.29	
3	REC528-B25F	50040-93829-OEP 50040-93851-OEP	X 25"	counter	12/22	2.29	
4	REC528-B30F	50060-93828-OEP 50060-93851-OEP	X 30"	counter	12/22	2.29	



4 STROKES

4 TIEMPOS

4 TEMPI

4 TEMPS

DF4, DF5, DF6

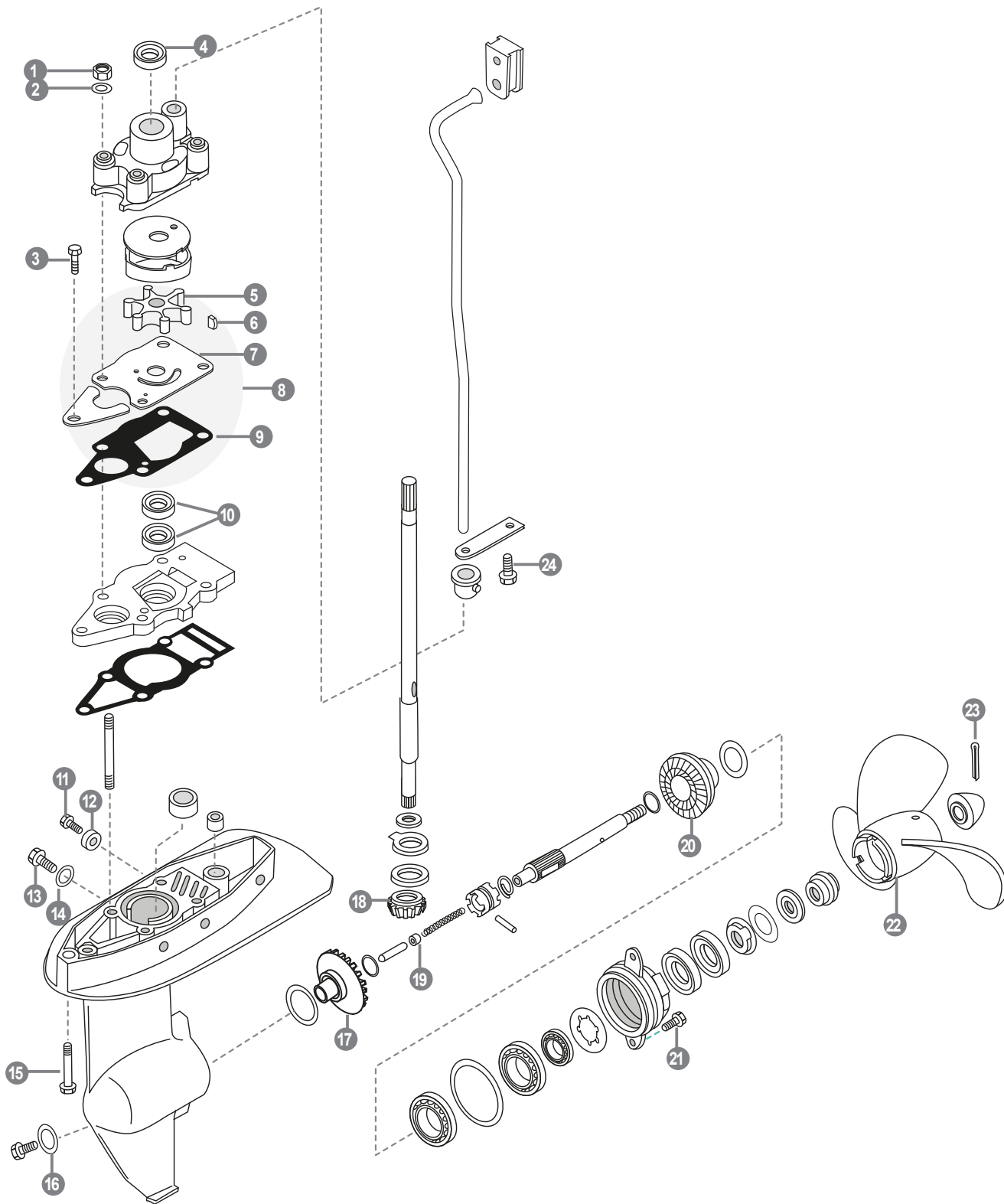

	REF	OEM				
1	REC95380-06700	29141-93J00	NUT HEXAGON M6	TUERCA HEXÁGONO M6	DADO ESAGONALE M6	ECROU HEXAGONAL M6
2	PAGB/T848-6	09160-06082	WASHER	ARANDELA	RONDELLA	RONDELLE
3	PAGB/T5283-M6X25	09116-06229	HEXAGON BOLT M6x25	TORNILLO HEXAGONAL M6x25	BULLONE ESAGONALE M6x25	BOULON HEXAGONAL M6x25
4	REC09289-10002	09289-10002	SEAL OIL 10 X 22 X 8	RETEN 10 X 22 X 8	PARAOLIO 10 X 22 X 8	JOINT D'HUILE 10 X 22 X 8
5	REC17461-98503	17461-985M0	IMPELLER	IMPULSOR	GIRANTE	TURBINE
6	REC09420-03002	09420-03002	KEY	CHAVETA IMPELLER	CHIUSURA	CLAVETTE TURBINE
7	REC17471-98610	17471-98610	PLATE	PLACA	PIASTRA	PLAQUE
8	REC17400-98661	17400-98661	WATER PUMP KIT	KIT BOMBA AGUA	KIT POMPA ACQUA	KIT POMPE À EAU
9	REC17472-91J00	17472-91J00	GASKET PUMPCASE	JUNTA DE LA BOMBA	GUARNIZIONE POMPA	JOINT DE POMPE
10	REC09282-10008	09282-10008	OIL SEAL	RETÉN ACEITE	PARAOLIO	JOINT SPI
11	PAGB/T5783-M6X14	09103-06281	HEXAGON BOLT M6x14	TORNILLO HEXAGONAL M6x14	BULLONE ESAGONALE M6x14	BOULON HEXAGONAL M6x14
12	REC55321-87J01AL	55321-87J00	ANODE	ÁNODO	ANODO	ANODE
13	REC09248-10008	09248-10008	SCREW 10x7,5	TORNILLO 10x7,5	VITE 10x7,5	VIS 10x7,5
14	REC09168-10022	09168-10022	CAP, O-RING	ARANDELA TAPÓN	RONDELLA TAPPO	JOINT DE VIDANGE
15	PAGB/T5787-1986	09116-08156	HEXAGON BOLT M8x50	TORNILLO HEXAGONAL M8x50	BULLONE ESAGONALE M8x50	BOULON HEXAGONAL M8x50
16	REC59178-97J00	59178-97J00	GASKET	JUNTA	GUARNIZIONE	JOINT
17	REC57510-91J00	57510-91J00	FORWARD GEAR	PIÑÓN MARCHA AVANTE	INGRANAGGIO MARCIA AVANTI	PIGNON MARCHE AV
18	REC57311-98600	57311-91J00	INITIATIVE GEAR	PIÑÓN ATAQUE	PIGNONE	PIGNON D'ATTAQUE
19	REC57632-97L00	57632-98501	SELECTOR PIN	PIN SELECTOR	PIN SELETTORE	CLAVETTE
20	REC57521-91J00	57521-91J00	RESERVE GEAR	PIÑÓN MARCHA ATRÁS	PIGNONE MARCIA INDIETRO	PIGNON MARCHE AR
21	PAGB/T5783-M6X16	09116-06225	HEXAGON BOLT M6x16	TORNILLO HEXAGONAL M6x16	BULLONE ESAGONALE M6x16	BOULON HEXAGONAL M6x16
22	SOL4011-079-07S	58110-91JN0-019	PROPELLER AMITA 3 7.9x6.75	HELICE AMITA 3 7.9x6.75	ELICA AMITA 3 7.9x6.75	HELICE AMITA 3 7.9x6.75
23	REC91490-30025	09204-03003	PIN	PASADOR	FERMO	GOUPILLE
24	PAGB/T5783-M6X16	09116-06225	HEXAGON BOLT M6x16	TORNILLO HEXAGONAL M6x16	BULLONE ESAGONALE M6x16	BOULON HEXAGONAL M6x16



REC80W90U3  
REC80W90U6

**+**  
INFO  
INSTAL.  
P. 18



RECGREU1  
RECGREU12

**+**  
INFO  
INSTAL.  
P. 20



**+**  
INFO  
INSTAL.  
P. 32



**+**  
INFO  
INSTAL.  
P. 33



**+**  
INFO  
INSTAL.  
P. 36

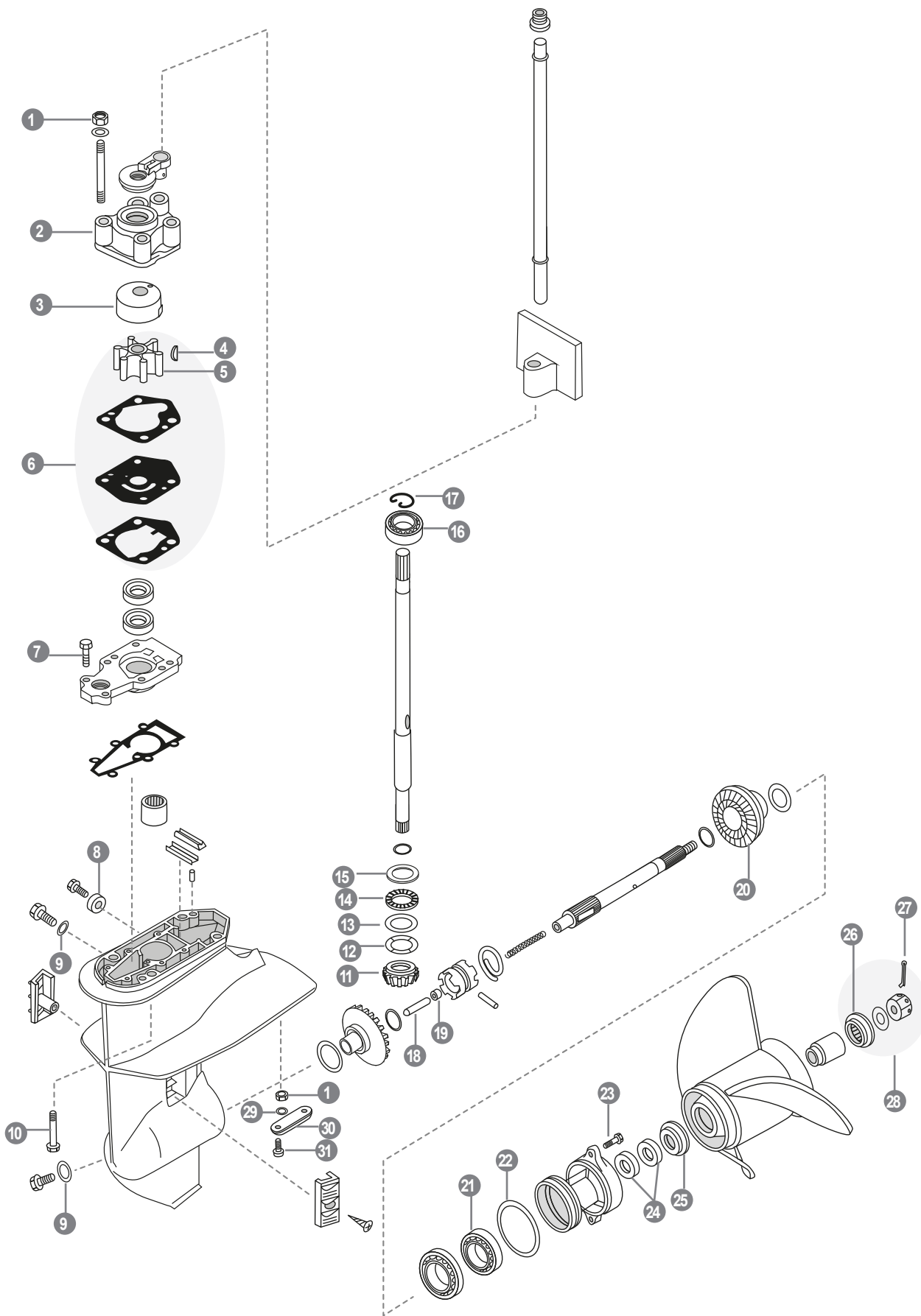

	REF	OEM				
1	REC95380-06700	29141-93J00	NUT HEXAGON M6	TUERCA HEXÁGONO M6	DADO ESAGONALE M6	ECROU HEXAGONAL M6
2	REC17411-94J00	17411-94J00	WATER PUMP COVER	CUERPO BOMBA AGUA	CORPO POMPA ACQUA	CORPS DE POMPE
3	REC17413-94J00	17413-94J00	WATER PUMP INSERT	CASQUILLO INOX BOMBA AGUA	CAPPUCCIO DELLA POMPA	INSERT POMPE A EAU
4	REC09420-03005	09420-03009	KEY	CHAVETA	CHIAVETTA	CLAVETTE
5	REC17461-93903	17461-939M0	IMPELLER	IMPULSOR	GIRANTE	TURBINE
6	REC17400-99J01	17400-99J01	PUMP KIT	KIT BOMBA	KIT POMPA	KIT POMPA À EAU
7	REC09116-06121	09116-06229	BOLT	TORNILLO	VITE	VIS
8	REC55321-87J01AL	55321-87J01	ANODE	ÁNODO	ANODO	ANODE
9	REC59178-97J00	59178-97J00	DRAIN PLUG GASKET	JUNTA DRENAJE COLA	GUARNIZIONE DRENAGGIO	JOINT DE VIDANGE
10	PAGB/T5783-M8X30	09116-08151	BOLT M8x30	PERNO M8x30	BULLONE M8x30	BOULON M8x30
11	REC57311-99J10	57311-99J10	INITIATIVE GEAR	PIÑON ATAQUE	PIGNONE	PIGNON D'ATTAQUE
	REC09160-20042	09160-20042	SHIM 1.10	GRUESO 1.10	SPESSORE 1.10	CALE 1.10
12	REC09160-20043	09160-20043	SHIM 1.20	GRUESO 1.20	SPESSORE 1.20	CALE 1.20
	REC09160-20044	09160-20044	SHIM 1.30	GRUESO 1.30	SPESSORE 1.30	CALE 1.30
13	REC09160-20027	09160-20027	WASHER GEAR	ARANDELA PIÑON	RONDELLA PIGNONE	RONDELLE DE PIGNON
14	REC09263-20L04	09263-20024	BEARING	RODAMIENTO	CUSCINETTO	ROUEMENT
15	REC09160-21009	09160-21009	WASHER GEAR	ARANDELA PIÑON	RONDELLA PIGNONE	RONDELLE DE PIGNON
16	REC08110-60020	08110-60020	BEARING	RODAMIENTO	CUSCINETTO	ROULEMENT
17	REC09380-15001	09380-15001	CLIP	CIRCLIP	CERCLIP	CLIPS
18	REC57631-93901	57631-93901	ROD PUSH	VARILLA SELECTOR	ASTA SELETTORE	CLAVETTE
19	REC57632-97L00	57632-97L00	SELECTOR PIN	PIN SELECTOR	PIN SELETTORE	CLAVETTE
20	REC57521-99J10	57521-99J10	PINION	PIÑON	PIGNONE	PIGNON
21	REC08110-60050	08110-60050	BEARING	RODAMIENTO	CUSCINETTO	ROULEMENT
22	REC09280-57002	09280-57002	O-RING	ARO TORICO	O-RING	JOINT TORIQUE
23	PAGB/T5787-M6X20	09116-06227	BOLT, FLANGE	TORNILLO	VITE	VIS DE BRIDE
24	REC09289-17006	09289-17L02	OIL SEAL	RETÉN ACEITE	PARAOLIO	JOINT SPI
25	REC57632-94J00	57632-94J00	PROPELLER WASHER	SEPARADOR HELICE	DISTANZIALE ELICA	RONDELLE HÉLICE
26	REC57633-93901	57633-93901	SPACER	SEPARADOR	DISTANZIALE	ENTRETOISE
27	REC09204-02004	09204-02004	COTTER PIN	PIN BLOQUEADOR	COPPIGLIA	GOUPILLE
28	REC57630-90J00	57630-99J00	PROP THRUST WASHER	KIT TOPE HELICE	KIT FERMO PER ELICA	KIT RONDELLE D'HELICE
29	PAGB/T93-6	29162-93J00	WASHER SPRING 6	ARANDELA MUELLE 6	RONDELLA MOLLA 6	RESSORT 6
30	REC55300-95500AL	55300-95500	ANODE	ÁNODO	ANODO	ANODE
31	PAGB/T820-M6X20	09126-06006	SCREW M6x20	TORNILLO M6x20	VITE M6x20	VIS M6x20



REC17400-99J01

REC80W90U3  
REC80W90U6

INFO  
INSTAL.  
P. 18

REGGREU1  
REGGREU12

INFO  
INSTAL.  
P. 20

INFO  
INSTAL.  
P. 32

Permatex

INFO  
INSTAL.  
P. 33

LOCTITE

INFO  
INSTAL.  
P. 36

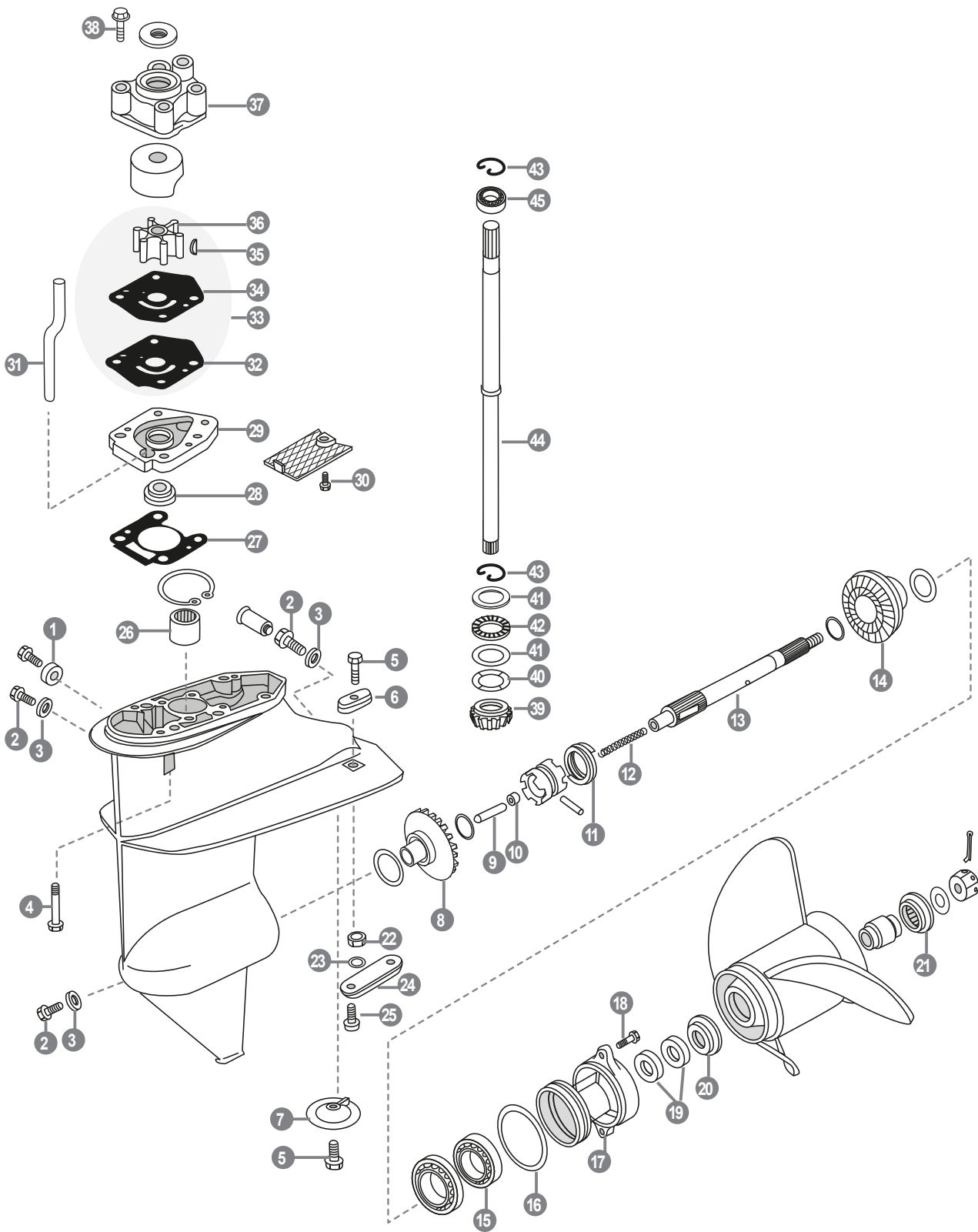

	REF	OEM				
1	REC55321-87J01AL	55321-87J00	ANODE	ÁNODO	ANODO	ANODE
2	REC09248-10008	09248-10008	SCREW 10x7,5	TORNILLO 10x7,5	VITE 10x7,5	VIS 10x7,5
3	REC09168-10022	09168-10022	CAP, O-RING	ARANDELA TAPÓN	RONDELLA TAPPO	JOINT DE VIDANGE
4	PAGB/T5783-M8X30	09117-08047	BOLT M8X30	TORNILLO M8X30	BULLONE M8X30	BOULON M8X30
5	REC09116-06094	09116-06094	SCREW 6x15	TORNILLO 6x15	VITE 6x15	VIS 6x15
6	REC55321-90L00A	41811-98500	ANODE	ÁNODO	ANODO	ANODE
7	REC55321-939L0AL	55321-93900	ANODE	ÁNODO	ANODO	ANODE
8	REC57510-93910	57510-93910	FORWARD GEAR	PIÑÓN MARCHA AVANTE	INGRANAGGIO MARCIA AVANTI	PIGNON MARCHE AVANT
9	REC57631-93901	67631-93901	ROD PUSH	VARILLA SELECTOR	ASTA SELETTORE	CLAVETTE
10	REC57632-97L00	57632-97L0	SELECTOR PIN	PIN SELECTOR	PIN SELETTORE	CLAVETTE
11	REC09440-32008	09440-32008	CLUTCH	MUELLE	MOLLA	RESSORT
12	REC09440-05027	09440-05027	SELECTOR SPRING	MUELLE SELECTOR	MOLLA SELETTORE	RESSORT DE SELECTEUR
13	REC57610-93901	57610-93901	PROPELLER SHAFT	EJE HELICE	ASSE ELICA	ARBRE D'HELICE
14	REC57521-93910	57521-93910	REVERSER GEAR	PIÑÓN MARCHA ATRÁS	INGRANAGGIO MARCIA INDIETRO	PIGNON MARCHE ARRIÈRE
15	REC08110-60050	08110-60050	BEARING	RODAMIENTO	CUSCINETTO	ROULEMENT
16	REC09280-57002	09280-57002	O-RING	ARO TORICO	O-RING	JOINT TORIQUE
17	REC56120-93900	56120-93901-OEP	CARRIER	DIÁBOLO	DIABOLO	DIABOLO
18	PAGB/T5787-M6X20	29116-93J00	BOLT, FLANGE	TORNILLO	VITE	VIS DE BRIDE
19	REC09289-17006	09289-17006	OIL SEAL	RETÉN ACEITE	PARAOLIO	JOINT SPI
20	REC57632-94J00	57632-93902	PROPELLER WASHER	SEPARADOR HÉLICE	DISTANZIALE ELICA	RONDELLE HÉLICE
21	REC57633-93901	57633-93901	SPACER	SEPARADOR	DISTANZIALE	ENTRETOISE
22	REC95380-06700	29141-93J00	HEXAGON NUT M6	TUERCA HEXÁGONAL M6	DADO ESAGONALE M6	ECROU HEXAGONAL M6
23	PAGB/T93-6	29162-93J00	SPRING WASHER 6	ARANDELA MUELLE 6	RONDELLA MOLLA 6	RESSORT RONDELLE 6
24	REC55300-95500AL	55300-95500	ANODE	ÁNODO	ANODO	ANODE
25	PAGB/T820-M6X20	09126-06006	SCREW M6x20	TORNILLO M6x20	VITE M6x20	VIS M6x20
26	REC09263-15019	09263-15019	BEARING	RODAMIENTO	CUSCINETTO	ROULEMENT
27	REC17452-93910	17452-93910	DRIVE GASKET	JUNTA COLA	GUARNIZIONE PIEDE	JOINT D'EMBASE
28	REC09289-12003	09289-12003	OIL SEAL	RETÉN	PARAOLIO	JOINT SPI
29	REC17450-93921	17450-93921	PUMP BASE	CARCASA BOMBA AGUA	BASE POMPA ACQUA	CORPS DE POMPE À EAU
30	PAGB/T818-M6X10	09125-06063	BOLT M6x10	TORNILLO M6x10	BULLONE M6x10	BOULON M6x10
31	REC17453-93901	17453-93900	WATER TUBE	TUBO VACIADO DE AGUA	TUBO ACQUA	TUBE VIDANGE D'EAU
32	REC17472-93911	17472-93911	WATER PUMP GASKET	JUNTA BOMBA AGUA	GUARNIZIONE POMPA ACQUA	JOINT DE POMPE À EAU
33	REC17400-93951	17400-93951	WATER PUMP SERVICE KIT	KIT BOMBA AGUA	KIT POMPA ACQUA	KIT POMPE À EAU
34	REC17471-93902	17471-93902	WATER PUMP PLATE	BASE BOMBA AGUA	COPERCHIO GIRANTE	BASE DE POMPE À EAU
35	REC17462-93990	17462-93990	KEY	CHAVETA	CHIAVETTA	CLAVETTE
36	REC17461-93903	17461-93903	IMPELLER	IMPULSOR	GIRANTE	TURBINE
37	REC17411-93901	17411-93901	HOUSING WATER PUMP	CUERPO BOMBA AGUA	CORPO POMPA ACQUA	CORPS DE POMPE À EAU
38	PAGB/T5783-M8X55	09116-08117	BOLT HEXAGON M8x55	TORNILLO HEXAGONAL M8x55	BULLONE ESAGONALE M8x55	VIS HEXAGONAL M8x55
39	REC57311-93910	57311-93910	INITIATIVE GEAR	PIÑÓN ATAQUE	PIGNONE ATTACCO	PIGNON D'ATTAQUE
40	REC09160-20041	09160-20041	SHIM 1.00	GRUESO 1.00	SPESSORE 1.00	CALE 1.00
	REC09160-20042	09160-20042	SHIM 1.10	GRUESO 1.10	SPESSORE 1.10	CALE 1.10
	REC09160-20043	09160-20043	SHIM 1.20	GRUESO 1.20	SPESSORE 1.20	CALE 1.20
	REC09160-20044	09160-20044	SHIM 1.30	GRUESO 1.30	SPESSORE 1.30	CALE 1.30
41	REC09160-21009	09160-21009	WASHER GEAR	ARANDELA PIÑÓN	RONDELLA PIGNONE	RONDELLE DE PIGNON
42	REC09263-20L04	09263-20L04	BEARING	RODAMIENTO	CUSCINETTO	ROULEMENT
43	REC09380-15001	09380-15001	CLIP	CIRCLIP	CERCLIP	CLIPS
44	REC57100-93902	57100-93902	DRIVE SHAFT	EJE VERTICAL	ASSE VERTICALE	ARBRE DE TRANSMISSION
45	REC08110-60020	08110-60020	BEARING	RODAMIENTO	CUSCINETTO	ROULEMENT



REC17400-93951



REC80W90U3  
REC80W90U6

**+**  
INFO  
INSTAL.  
P. 18



REGREU1  
REGREU12

**+**  
INFO  
INSTAL.  
P. 20



**+**  
INFO  
INSTAL.  
P. 32

**Permatex**



**+**  
INFO  
INSTAL.  
P. 33

**LOCTITE**

**+**  
INFO  
INSTAL.  
P. 36

DF9.9B, DF15A, DF20A

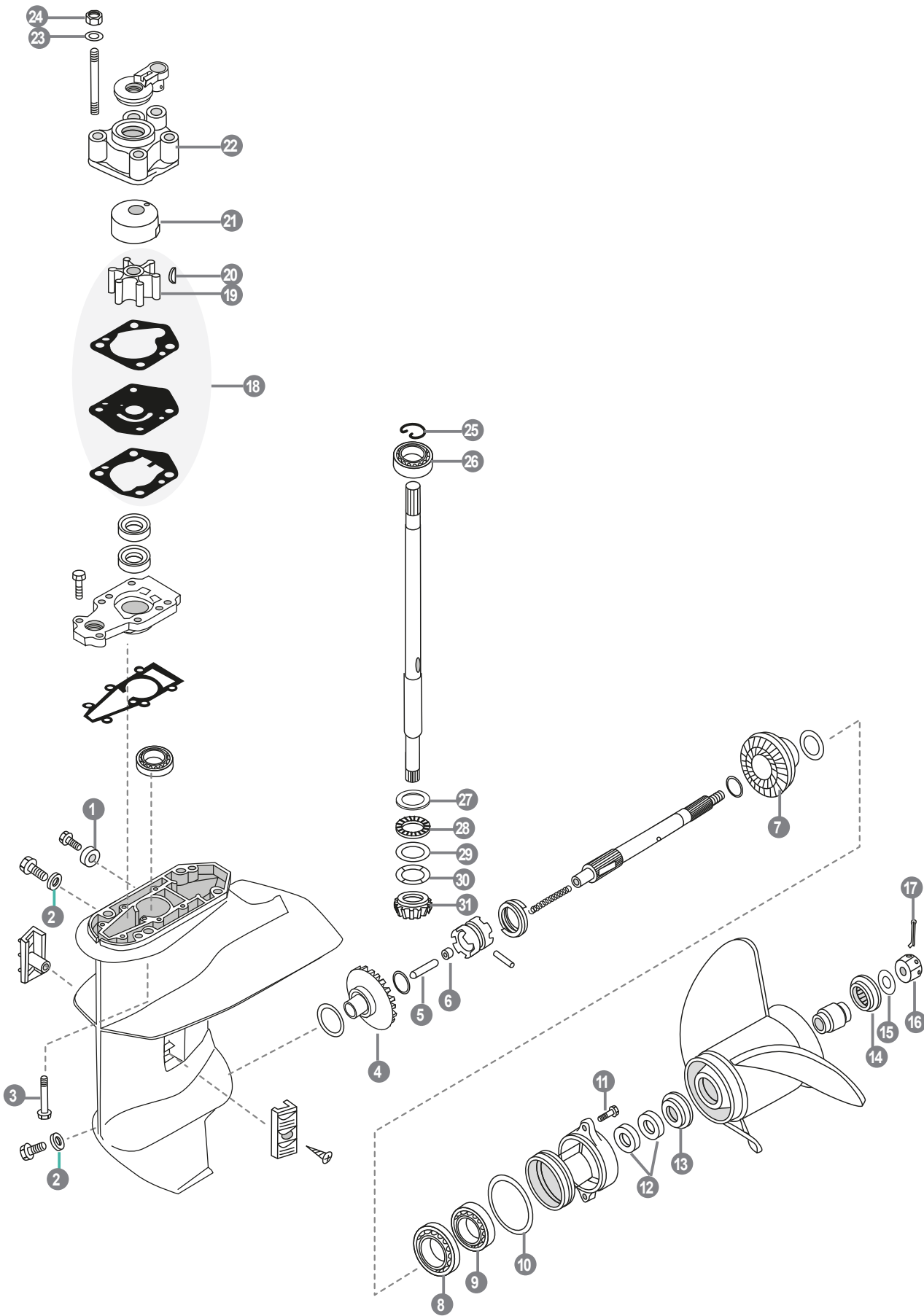

	REF	OEM				
1	REC55321-87J01AL	55321-87J01	ANODE	ÁNODO	ANODO	ANODE
2	REC59178-97J00	59178-97J00	DRAIN PLUG GASKET	JUNTA DRENAJE COLA	GUARNIZIONE DRENAGGIO	JOINT DE VIDANGE
3	PAGB/T5783-M8X30	09116-08151	BOLT M8x30	TORNILLO M8x30	BULLONE M8x30	BOULON M8x30
4	REC57510-99J11	57510-99J10	POSITIVE GEAR	PIÑÓN MARCHA AVANTE	PIGNONE MARCIA AVANTI	PIGNON MARCHE AVANT
5	REC57631-93901	57631-93901	ROD PUSH	VARILLA SELECTOR	ASTA SELETTORE	CLAVETTE
6	REC57632-97L00	57632-97L00	SELECTOR PIN	PIN SELECTOR	PIN SELETTORE	CLAVETTE
7	REC57521-99J10	57521-99J10	REVERSE GEAR	PIÑÓN MARCHA ATRÁS	PIGNONE MARCIA INDIETRO	PIGNON MARCHE ARRIÈRE
8	REC09262-25078	09262-25003	CRANKSHAFT BEARING	COJINETE CIGÜEÑAL	CUSCINETTO ALBERO MOTORE	PALIER DE VILEBREQUIN
9	REC08110-60050	08110-60050	BEARING	RODAMIENTO	CUSCINETTO	ROULEMENT
10	REC09280-57002	09280-57002	O-RING	ARO TORICO	O-RING	JOINT TORIQUE
11	PAGB/T5787-M6X20	09116-06227	BOLT, FLANGE	TORNILLO	VITE	VIS DE BRIDE
12	REC09289-17006	09289-17L02	OIL SEAL	RETÉN ACEITE	PARAOLIO	JOINT SPI
13	REC57632-94J00	57632-94J00	PROPELLER WASHER, BACK	SEPARADOR HELICE TRASERO	DISTANZIALE ELICA, POSTERIORE	RONDELLE HÉLICE, ARRIÈRE
14	REC57633-93901	57633-93901	PROPELLER WASHER, FRONT	SEPARADOR HELICE DELANTERO	DISTANZIALE ELICA, ANTERIORE	RONDELLE HÉLICE, AVANT
15	REC09160-12066	09160-12066	WASHER	ARANDELA	RONDELLA	RONDELLE
16	REC09141-12005	09141-12005	PROPELLER NUT	TUERCA HÉLICE	DADO ELICA	ECROU D'HELICE
17	REC09204-02004	09204-02004	COTTER PIN	PIN BLOQUEADOR	COPPIGLIA	GOUPILLE
18	REC17400-99J01	17400-99J01	PUMP KIT	KIT BOMBA	KIT POMPA	KIT POMPA À EAU
19	REC17461-93903	17461-93903	IMPELLER	IMPULSOR	GIRANTE	TURBINE
20	REC09420-03005	09420-03005	KEY	CHAVETA	CHIAVETTA	CLAVETTE
21	REC17413-94J00	17413-94J00	WATER PUMP INSERT	CASQUILLO INOX	CAPPUCCIO DELLA POMPA	INSERT POMPE A EAU
22	REC17411-94J00	17411-94J00	WATER PUMP HOUSING	CUERPO BOMBA AGUA	CORPO POMPA ACQUA	CORPS DE POMPE
23	PAGB/T848-6	09160-06082	WHASER M6	ARANDELA M6	RONDELLA M6	RONDELLE M6
24	PAGB/T6184-2000	29141-93J00	NUT M6	TUERCA M6	DADO M6	ÉCROU M6
25	REC09380-15001	09380-15001	CLIP	CIRCLIP	CERCLIP	CLIPS
26	REC08110-60020	08110-60020	BEARING	RODAMIENTO	CUSCINETTO	ROULEMENT
27	REC09160-21009	09160-21009	WASHER GEAR	ARANDELA PIÑÓN	RONDELLA PIGNONE	RONDELLE DE PIGNON
28	REC09263-20L04	09263-20L04	BEARING	RODAMIENTO	CUSCINETTO	ROULEMENT
29	REC09160-20027	09160-20027	WASHER GEAR	ARANDELA PIÑÓN	RONDELLA PIGNONE	RONDELLE DE PIGNON
30	REC09160-20041	09160-20041	SHIM 1.00	GRUESO 1.00	SPESSORE 1.00	CALE 1.00
	REC09160-20042	09160-20042	SHIM 1.10	GRUESO 1.10	SPESSORE 1.10	CALE 1.10
	REC09160-20043	09160-20043	SHIM 1.20	GRUESO 1.20	SPESSORE 1.20	CALE 1.20
	REC09160-20044	09160-20044	SHIM 1.30	GRUESO 1.30	SPESSORE 1.30	CALE 1.30
31	REC57311-99J10	57311-97J10	INITIATIVE GEAR	PIÑÓN ATAQUE	PIGNONE	PIGNON D'ATTAQUE



REC17400-99J01



REC80W90U3  
REC80W90U6

**+**  
INFO  
INSTAL.  
P. 18



RECGREU1  
RECGREU12

**+**  
INFO  
INSTAL.  
P. 20



**+**  
INFO  
INSTAL.  
P. 32

**Permatex**



**+**  
INFO  
INSTAL.  
P. 33

**LOCTITE**

**+**  
INFO  
INSTAL.  
P. 36

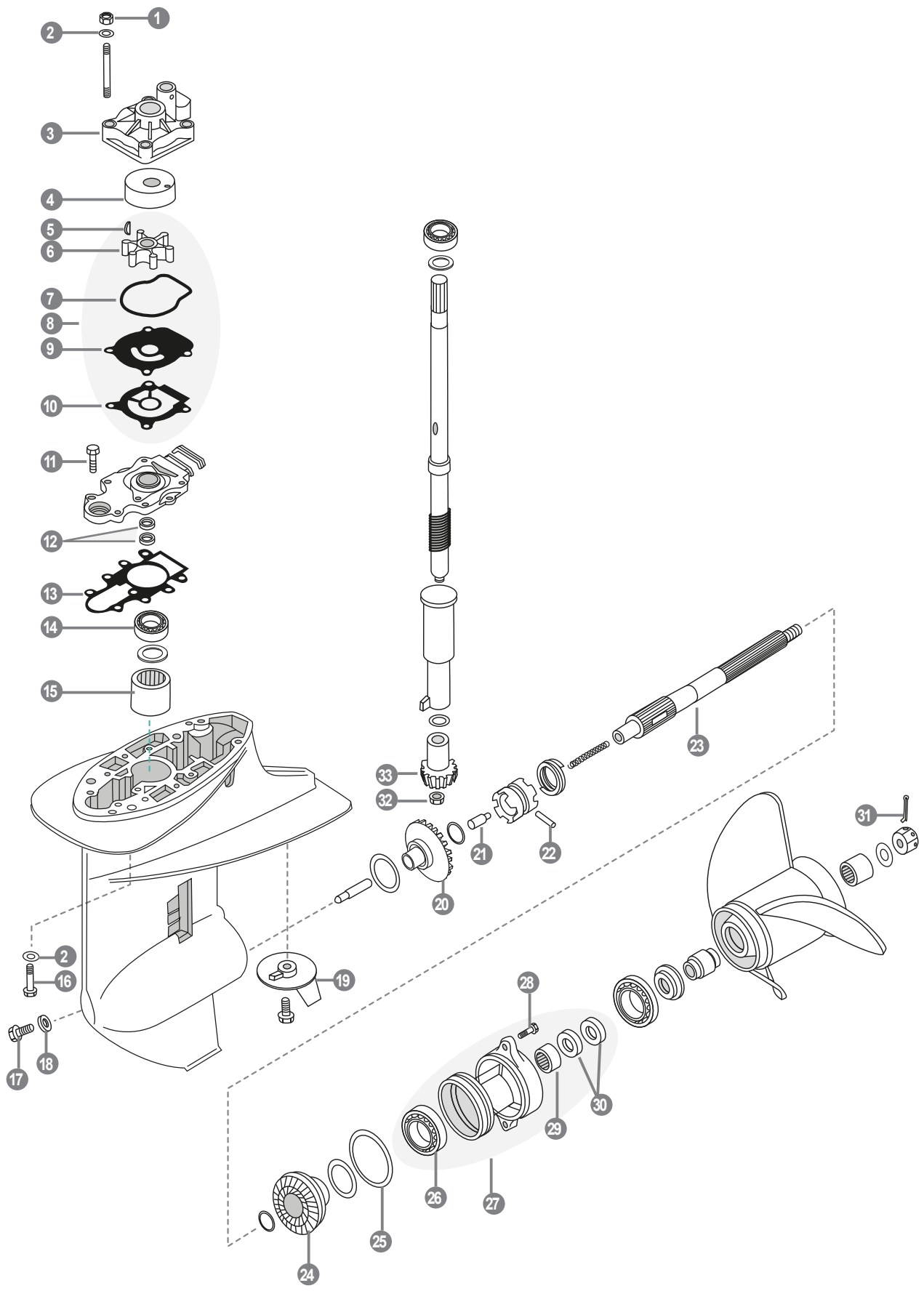

	REF	OEM				
1	REC95380-06700	29141-93J00	NUT HEXAGON M6	TUERCA HEXÁGONO M6	DADO ESAGONALE M6	ECROU HEXAGONAL M6
2	PAGB/T848-6	09160-06082	WASHER	ARANDELA	RONDELLA	RONDELLE
3	REC17410-95J00	17410-95J00	WATER PUMP HOUSING	CUERPO BOMBA AGUA	CORPO DELLA POMPA DELL'ACQUA	CORPS DE LA POMPE A EAU
4	REC17413-95J00	17413-95J00	SLEEVE WATER PUMP	CASQUILLO INOX	CAPPUCCIO	INSERT DE POMPE À EAU
5	REC09420-04006	09420-04006	KEY	CHAVETA	CHIAVETTA	CLAVETTE
6	REC17461-96312	17461-96312	IMPELLER	IMPULSOR	GIRANTE	TURBINE
7	REC17416-95J00	17416-95J00	O-RING	ARO TÓRICO	FASCIA TONDA	JOINT TORIQUE
8	REC17400-95J02	17400-95J02	WATER PUMP KIT	KIT BOMBA DE AGUA	KIT POMPA ACQUA	KIT POMPE A EAU
9	REC17471-95J01	17471-95J01	OUTER PLATE CARTRIDGE	TAPA DEL IMPULSOR	COPERCHIO GIRANTE	PLAQUE DE POMPE À EAU
10	REC17472-96303	17472-96303	WATER PUMP, GASKET	JUNTA DE LA BOMBA DE AGUA	GUARNIZIONE POMPA ACQUA	JOINT POMPE À EAU
11	REC09116-06094	09116-06094	SCREW 6x15	TORNILLO 6x15	VITE 6x15	VIS 6x15
12	REC09282-17006	09282-17006	SEAL OIL	RETÉN	PARAOLIO	JOINT D'HUILE
13	REC56132-95J00	56132-95J00	WATER PUMP HOUSING GASKET	JUNTA BASE	GUARNIZIONE BASE POMPA ACQUA	JOINT D'EMBASE DE LA POMPE À EAU
14	REC09265-17002	09265-17002	BEARING	RODAMIENTO	CUSCINETTO	ROULEMENT
15	REC09263-20046	09263-20046	BEARING	RODAMIENTO	CUSCINETTO	ROULEMENT
16	PAGB/T5787-M6X30	09116-08122	BOLT M6x30	TORNILLO M6x30	BULLONE M6x30	BOULON M6x30
17	REC09248-10008	09248-10008	SCREW 10x7,5	TORNILLO 10x7,5	VITE 10x7,5	VIS M10x7,5
18	REC09168-10022	09168-10022	CAP, O-RING	ARANDELA TAPÓN	RONDELLA TAPPO	JOINT DE VIDANGE
19	REC55125-91L01AL	55125-96310	ANODE	ÁNODO	ANODO	ANODE
20	REC57510-89J00	57510-89J00	POSITIVE GEAR	PIÑÓN MARCHA AVANTE	PIGNONE MARCIA AVANTI	PIGNON MARCHE AVANT
21	REC09209-08016	09209-08016	ROD PUSH	VARILLA PRESION ACEITE	ASTA PRESSIONE OLIO	CLAVETTE
22	REC09202-05021	09202-05021	PIN	PIN	SPINOTTO	CLAVETTE
23	REC57610-96311	57610-96311	PROPELLER SHAFT	EJE HELICE	ASSE ELICA	ARBRE D'HELICE
24	REC57521-89J00	57521-89J00	REVERSER GEAR	PIÑÓN MARCHA ATRÁS	PIGNONE MARCIA INDIETRO	PIGNON MARCHE ARRIÈRE
25	REC09280-75001	09280-75001	O-RING	ARO TÓRICO	FASCIA TONDA	JOINT TORIQUE
26	REC08113-60060	08113-60060	BEARING	RODAMIENTO	CUSCINETTO	ROULEMENT
27	REC56120-96332-OEP	56120-96332-OEP	CARRIER	DIÁBOLO	DIABOLO	DIABOLO
28	REC09116-06121	09116-06121	BOLT	TORNILLO	VITE	VIS
29	REC09263-20047	09263-20047	BEARING	RODAMIENTO	CUSCINETTO	ROULEMENT
30	REC09289-20009	09289-20009	OIL SEAL	RETÉN ACEITE	PARAOLIO	JOINT SPI
31	REC91490-30025	09204-03003	COTTER PIN	PIN BLOQUEADOR	COPPIGLIA	GOUPILLE
32	REC90179-08M06	09159-08046	NUT, PINION M8X1	TUERCA DE PIÑÓN M8X1	DADO PIGNONE M8X1	ECROU DE PIGNON M8
33	REC57311-96320	57311-96320	INITIATIVE GEAR	PIÑÓN ATAQUE	PIGNONE ATTACCO	PIGNON D'ATTAQUE



REC57630-96300



REC25700-95J00



REC80W90U3  
REC80W90U6

INFO  
INSTAL.  
P. 18

REGREU1  
REGREU12

INFO  
INSTAL.  
P. 20

Permatex

INFO  
INSTAL.  
P. 32

Permatex

INFO  
INSTAL.  
P. 33

LOCTITE

INFO  
INSTAL.  
P. 36

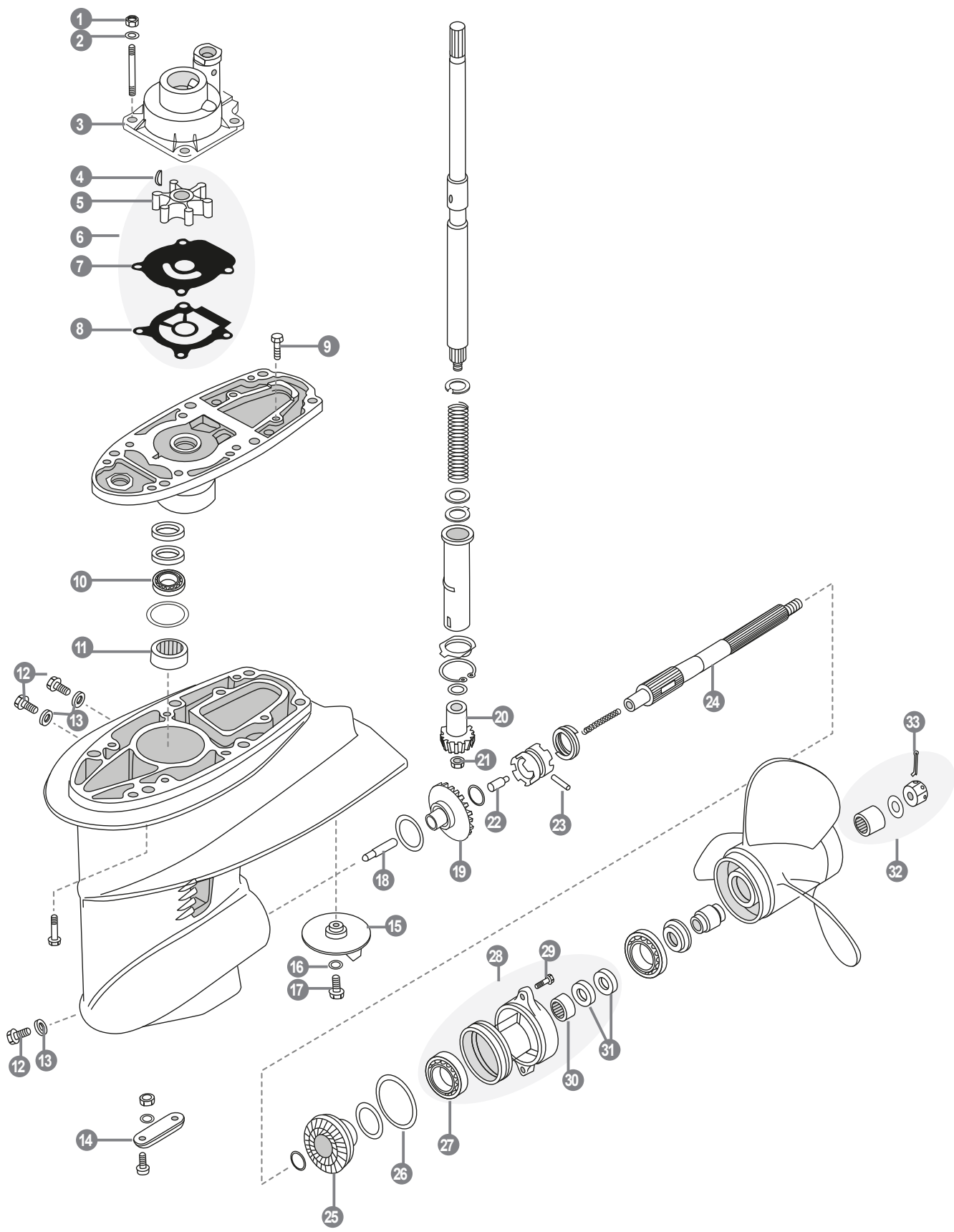

REF	OEM					
1	PAGB/T6184-2000	09141-06020	NUT M6	TUERCA M6	DADO M6	ÉCROU M6
2	PAGB/T848-6	09162-06006	WASHER	ARANDELA	RONDELLA	RONDELLE
3	REC17411-94421	17411-94421	HOUSING WATER PUMP	CUERPO BOMBA AGUA	CORPO POMPA ACQUA	CORPS DE POMPE À EAU
4	REC09420-04006	09420-04006	KEY	CHAVETA	CHIAVETTA	CLAVETTE
5	REC17461-96312	17461-96312	IMPELLER	IMPULSOR	GIRANTE	TURBINE
6	REC17400-96403	17400-96352	WATER PUMP KIT	KIT BOMBA DE AGUA	KIT POMPA ACQUA	KIT POMPE A EAU
7	REC17471-94401	17471-94401	PLATE, WATER PUMP	BASE BOMBA AGUA	BASE POMPA ACQUA	BASE DE POMPE À EAU
8	REC17472-96303	17472-96303	WATER PUMP, GASKET	JUNTA DE LA BOMBA DE AGUA	GUARNIZIONE POMPA ACQUA	JOINT POMPE À EAU
9	PAGB/T5787-M6X20	09116-06106	BOLT, FLANGE	TORNILLO	VITE	VIS DE BRIDE
10	REC09265-17002	09265-17002	BEARING	RODAMIENTO	CUSCINETTO	ROULEMENT
11	REC09263-20046	09263-20046	BEARING	RODAMIENTO	CUSCINETTO	ROULEMENT
12	REC09248-10008	09248-10008	SCREW 10x7,5	TORNILLO 10x7,5	VITE 10x7,5	VIS 10x7,5
13	REC09168-10022	09168-10022	CAP, O-RING	ARANDELA TAPÓN	RONDELLA TAPPO	JOINT DE VIDANGE
14	REC55300-95500AL	55300-95500	ANODE	ÁNODO	ANODO	ANODE
15	REC55125-91L01AL	55125-96310	ANODE	ÁNODO	ANODO	ANODE
16	PAGB/T97.1-8		WASHER 8	ARANDELA 8	RONDELLA 8	RONDELLE 8
17	PAGB/T5783-M8X16	09117-08037	BOLT M8x16	TORNILLO M8x16	BULLONE M8x16	BOULON M8x16
18	REC57631-96301	57631-96301	ROD PUSH	VARILLA PRESION ACEITE	ASTA PRESSIONE OLIO	CLAVETTE
19	REC57510-89J00	57510-89J00	POSITIVE GEAR	PIÑÓN MARCHA AVANTE	PIGNONE MARCIA AVANTI	PIGNON MARCHE AVANT
20	REC57311-96320	57311-96320	INITIATIVE GEAR	PIÑÓN ATAQUE	PIGNONE ATTACCO	PIGNON D'ATTAQUE
21	REC90179-08M06	09159-08046	NUT, PINION M8X1	TUERCA DE PIÑÓN M8X1	DADO PIGNONE M8X1	ECROU DE PIGNON M8
22	REC09209-08016	09209-08016	ROD PUSH	VARILLA PRESION ACEITE	ASTA PRESSIONE OLIO	CLAVETTE
23	REC09202-05021	09202-05021	PIN	PIN	SPINOTTO	CLAVETTE
24	REC57610-96311	57610-96311	PROPELLER SHAFT	EJE HELICE	ASSE ELICA	ARBRE D'HELICE
25	REC57521-89J00	57521-89J00	REVERSER GEAR	PIÑÓN MARCHA ATRÁS	PIGNONE MARCIA INDIETRO	PIGNON MARCHE ARRIÈRE
26	REC925093	09280-75002	O-RING UPPER	ARO TORICO SUPERIOR	O-RING SUPERIORE	JOINT TORIQUE SUPERIEUR
27	REC08113-60060	08113-60060	BEARING	RODAMIENTO	CUSCINETTO	ROULEMENT
28	REC56120-96332-0EP	56120-96332-0EP	CARRIER	DIÁBOLO	DIABOLO	DIABOLO
29	REC09116-06121	09116-06121	BOLT	TORNILLO	VITE	VIS
30	REC09263-20047	09263-20047	BEARING	RODAMIENTO	CUSCINETTO	ROULEMENT
31	REC09289-20009	09289-20009	OIL SEAL	RETÉN ACEITE	PARAOLIO	JOINT SPI
32	REC57630-96300	57630-96300	PROP NUT KIT	KIT CIERRE DE HÉLICE	KIT CHIUSURA ELICA	KIT ECROU D'HELICE
33	REC91490-30025	09204-03003	COTTER PIN	PIN BLOQUEADOR	COPPIGLIA	GOUPILLE

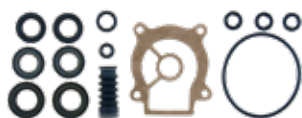

REC25700-95D01



REC80W90U3  
REC80W90U6

+  
INFO  
INSTAL.  
P. 18



REGGREU1  
REGGREU12

+  
INFO  
INSTAL.  
P. 20



+  
INFO  
INSTAL.  
P. 32



+  
INFO  
INSTAL.  
P. 33



+  
INFO  
INSTAL.  
P. 36

DF40, DF50

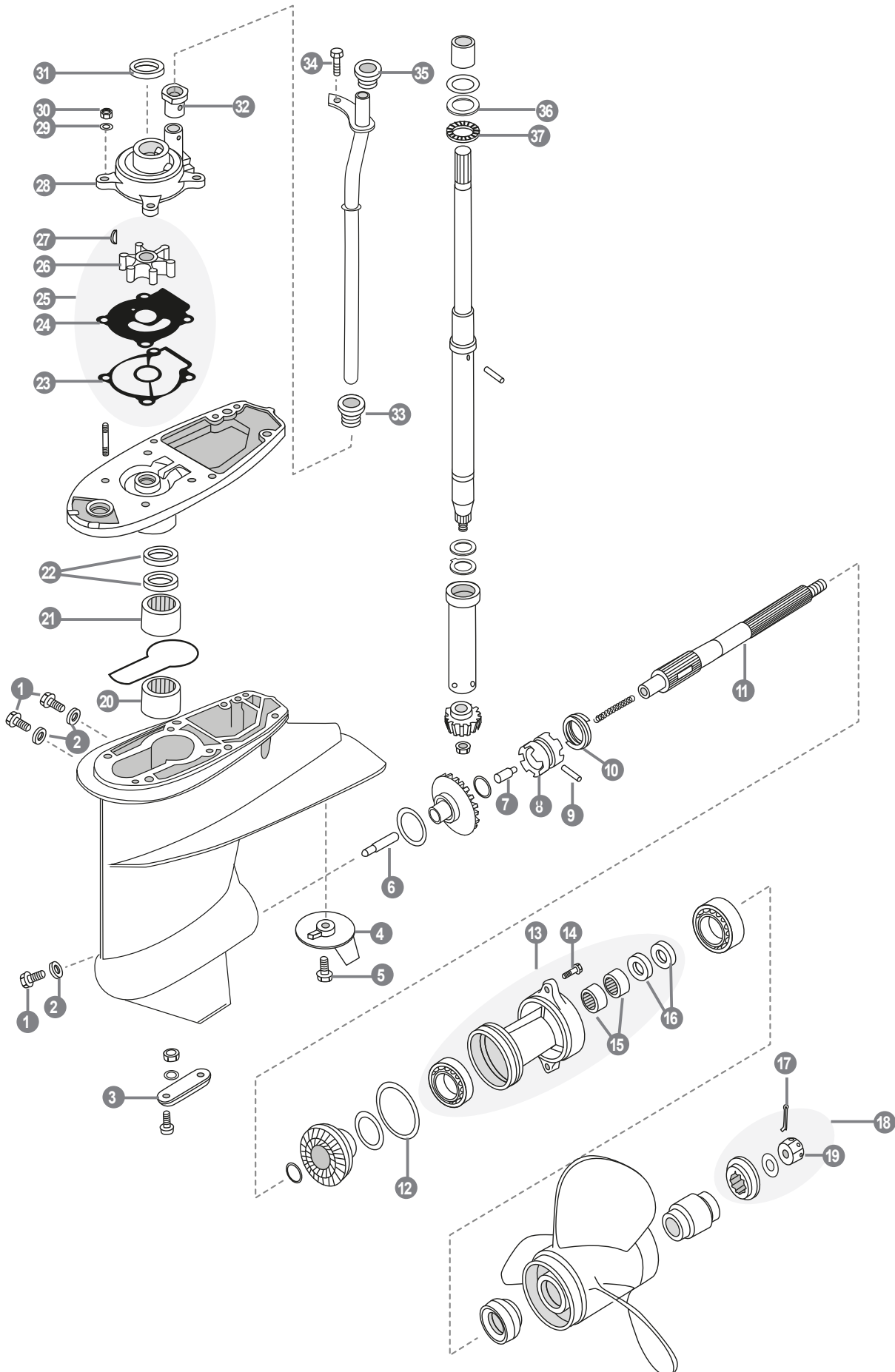

	REF	OEM				
1	REC09248-10008	09248-10008	SCREW 10x7,5	TORNILLO 10x7,5	VITE 10x7,5	VIS M10x7,5
2	REC09168-10022	09168-10022	CAP, O-RING	ARANDELA TAPÓN	RONDELLA TAPPO	JOINT DE VIDANGE
3	REC55300-95500AL	55300-95500	ANODE	ÁNODO	ANODO	ANODE
4	REC55125-95500AL	55125-95500	ANODE	ÁNODO	ANODO	ANODE
5	PAGB/T5783-M8X16	09117-08109	BOLT M8x16	TORNILLO M8x16	BULLONE M8x16	BOULON M8x16
6	REC57631-95303	57631-95303	ROD PUSH	VARILLA PRESION ACEITE	ASTA PRESSIONE OLIO	CLAVETTE
7	REC57634-88L00	57634-88L00	CLUTCH PIN	PIN SELECTOR	PIN SELETTORE	CLAVETTE
8	REC57621-94403	57621-87J03	SELETTORE	SELECTOR	CLUTCH DOG	CRABOT
9	REC09202-04002	09202-04002	PROPELLER PIN	PIN HELICE	PIN ELICA	CLAVETTE D'HELICE
10	REC09440-40002	09440-40002	SPRING CLUTCH	MUELLE SELECTOR	MOLLA SELETTORE	RESSORT
11	REC57610-94402	57610-94402	PROPELLER SHAFT	EJE HELICE	ASSE ELICA	ARBRE D'HELICE
12	REC09280-75001	09280-75001	O-RING	ARO TÓRICO	FASCIA TONDA	JOINT TORIQUE
13	REC56120-94321-OEP	56120-94321-OEP	CARRIER	DIÁBOLO	DIABOLO	DIABOLO
14	PAGB/T5783-M8X30	09117-08047	BOLT M8x30	TORNILLO M8x30	BULLONE M8x30	BOULON M8x30
15	REC09263-22020	09263-22020	BEARING	RODAMIENTO	CUSCINETTO	ROULEMENT
16	REC09289-22007	09289-22007	OIL SEAL	RETÉN ACEITE	PARAOLIO	JOINT SPI
17	REC91490-30025	09204-03003	COTTER PIN	PIN BLOQUEADOR	COPPIGLIA	GOUPILLE
18	REC57630-94300	57630-94301	PROP NUT KIT	KIT CIERRE DE HÉLICE	KIT CHIUSURA ELICA	KIT ECROU D'HELICE
19	REC90171-18M04	09141-18005	NUT	TUERCA	DADO	ÉCROU
20	REC09263-22L03	09263-22039	BEARING	RODAMIENTO	CUSCINETTO	ROULEMENT
21	REC09263-25025	09263-25025	BEARING	RODAMIENTO	CUSCINETTO	ROULEMENT
22	REC09282-17005	09282-17005	OIL SEAL	RETÉN ACEITE	PARAOLIO	JOINT SPI
23	REC17472-96303	17472-96303	WATER PUMP, GASKET	JUNTA DE LA BOMBA DE AGUA	GUARNIZIONE POMPA ACQUA	JOINT POMPE À EAU
24	REC17471-94401	17471-94401	PLATE, WATER PUMP	BASE BOMBA AGUA	BASE POMPA ACQUA	BASE DE POMPE À EAU
25	REC17400-96403	17400-96403	WATER PUMP KIT	KIT BOMBA DE AGUA	KIT POMPA ACQUA	KIT POMPE A EAU
26	REC17461-96312	17461-96312	IMPELLER	IMPULSOR	GIRANTE	TURBINE
27	REC09420-04006	09420-04006	KEY	CHAVETA	CHIAVETTA	CLAVETTE
28	REC17411-94421	17411-94421	HOUSING WATER PUMP	CUERPO BOMBA AGUA	CORPO POMPA ACQUA	CORPS DE POMPE À EAU
29	PAGB/T93-6	29162-93J00	WASHER 6	ARANDELA 6	RONDELLA 6	RONDELLE 6
30	REC95380-06700	29141-93J00	NUT HEXAGON M6	TUERCA HEXÁGONO M6	DADO ESAGONALE M6	ECROU HEXAGONAL M6
31	REC09282-17007	09282-17007	SEAL OIL	RETÉN	PARAOLIO	JOINT D'HUILE
32	REC17566-94400	17566-94400	WATER HOSE	GOMA TUBO AGUA	GOMMA TUBO ACQUA	BAGUE DE TUBE D'EAU
33	REC17565-94400	17565-94900	WATER HOSE	GOMA TUBO AGUA	GOMMA TUBO ACQUA	BAGUE DE TUBE D'EAU
34	REC09116-06094	09116-06094	SCREW 6x15	TORNILLO 6x15	VITE 6x15	VIS 6x15
35	REC17563-94400	17563-94400	RUBBER BUSHING	CASQUILLO DE GOMA	GUARNIZIONE IN GOMMA	MANCHON EN CAOUTCHOUC
36	REC09160-26015	09160-26015	WASHER GEAR	ARANDELA PIÑÓN	RONDELLA PIGNONE	RONDELLE DE PIGNON
37	REC09263-25062	09263-25062	BEARING	RODAMIENTO	CUSCINETTO	ROULEMENT



REC17400-96403

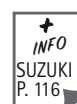

REC25700-88L00



REC80W90U3  
REC80W90U6



INSTAL.  
P. 18



REGREU1  
REGREU12



INSTAL.  
P. 20



Permatex



INSTAL.  
P. 32



INSTAL.  
P. 33



INSTAL.  
P. 36

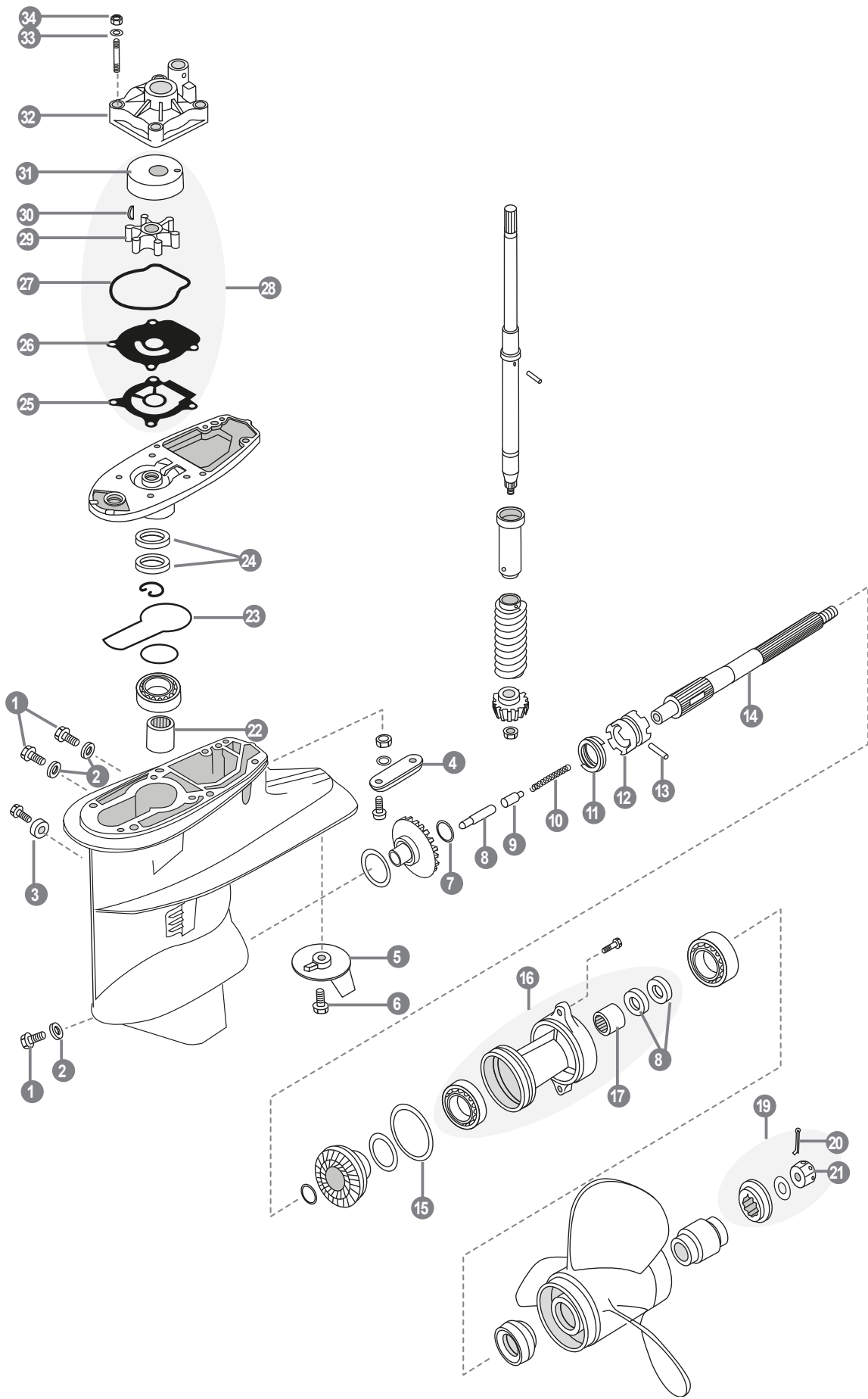

	REF	OEM				
1	REC09248-10008	09248-10008	SCREW 10x7,5	TORNILLO 10x7,5	VITE 10x7,5	VIS 10x7,5
2	REC09168-10022	09168-10022	CAP, O-RING	ARANDELA TAPÓN	RONDELLA TAPPO	JOINT DE VIDANGE
3	REC55321-87J01AL	55321-87J00	ANODE	ÁNODO	ANODO	ANODE
4	REC55300-95500AL	55300-95500	ANODE	ÁNODO	ANODO	ANODE
5	REC55125-95500AL	55125-95500	ANODE	ÁNODO	ANODO	ANODE
6	PAGB/T5783-M8X16	09117-08109	BOLT M8x16	TORNILLO M8x16	BULLONE M8x16	BOULON M8x16
7	REC08211-20263	08211-20263	WASHER	ARANDELA	RONDELLA	RONDELLE
8	REC57631-95303	57631-95303	ROD PUSH	VARILLA DE PRESIÓN	ASTA PRESSIONE OLIO	DOIGT
9	REC57634-88L00	57634-88L00	CLUTCH PIN	PIN SELECTOR	PIN SELETTORE	CALVETTE
10	REC09440-08043	09440-08043	SPRING CLUTCH	MUELLE SELECTOR	MOLLA SELETTORE	RESSORT DE SELECTEUR
11	REC09440-40002	09440-40002	SPRING CLUTCH	MUELLE SELECTOR	MOLLA SELETTORE	RESSORT DE SELECTEUR
12	REC57621-94403	57621-87J03	SELETTORE	SELECTOR	CLUTCH DOG	CRABOT
13	REC09202-05022	09202-05022	CLUTCH PIN	PIN SELECTOR	PIN SELETTORE	CALVETTE
14	REC57610-94402	57610-94402	PROPELLER SHAFT	EJE HELICE	ASSE ELICA	ARBRE D'HELICE
15	REC09280-75001	09280-75001	O-RING	ARO TÓRICO	FASCIA TONDA	JOINT TORIQUE
16	REC56120-94321-0EP	56120-94321-0EP	CARRIER	DIÁBOLO	DIABOLO	DIABOLO
17	REC09263-22020	09263-22020	BEARING	RODAMIENTO	CUSCINETTO	ROULEMENT
18	REC09289-22007	09289-22007	OIL SEAL	RETÉN ACEITE	PARAOLIO	JOINT SPI
19	REC57630-94300	57630-94300	PROP NUT KIT	KIT CIERRE DE HÉLICE	KIT CHIUSURA ELICA	KIT ECROU D'HELICE
20	REC91490-30025	09204-03003	COTTER PIN	PIN BLOQUEADOR	COPPIGLIA	GOUPILLE
21	REC90171-18M04	09141-18005	NUT	TUERCA	DADO	ÉCROU
22	REC09263-22L03	09263-22039	BEARING	RODAMIENTO	CUSCINETTO	ROULEMENT
23	REC55122-94400	55122-88L00	O-RING	JUNTA TORICA	O-RING	JOINT TORIQUE
24	REC09282-17005	09282-17005	OIL SEAL	RETÉN ACEITE	PARAOLIO	JOINT SPI
25	REC17472-96303	17472-96303	WATER PUMP, GASKET	JUNTA DE LA BOMBA DE AGUA	GUARNIZIONE POMPA ACQUA	JOINT POMPE À EAU
26	REC17471-95J01	17471-95J01	OUTER PLATE CARTRIDGE	TAPA DEL IMPULSOR	COPERCHIO GIRANTE	PLAQUE DE POMPE À EAU
27	REC17416-95J00	17416-95J00	O-RING	ARO TÓRICO	FASCIA TONDA	JOINT TORIQUE
28	REC17400-88L00	17400-88L00	WATER PUMP KIT	KIT BOMBA DE AGUA	KIT POMPA ACQUA	KIT POMPE A EAU
29	REC17461-96312	17461-96312	IMPELLER	IMPULSOR	GIRANTE	TURBINE
30	REC09420-04006	09420-04006	KEY	CHAVETA	CHIAVETTA	CLAVETTE
31	REC17413-95J00	17413-95J00	SLEEVE WATER PUMP	CASQUILLO INOX	CAPPUCCIO	INSERT DE POMPE À EAU
32	REC17410-88L00	17410-88L00	WATER PUMP COVER	CUERPO BOMBA AGUA	CORPO DELLA POMPA DELL'ACQUA	CARTER DE LA POMPE A EAU
33	PAGB/T93-6	29162-93J00	WASHER SPRING 6	ARANDELA MUELLE 6	RONDELLA MOLLA 6	RESSORT 6
34	REC95380-06700	29141-93J00	NUT HEXAGON M6	TUERCA HEXÁGONO M6	DADO ESAGONALE M6	ECROU HEXAGONAL M6



REC25700-88L00



REC80W90U3  
REC80W90U6

+  
INFO  
INSTAL.  
P. 18



REGREU1  
REGREU12

+  
INFO  
INSTAL.  
P. 20



Permatex

+  
INFO  
INSTAL.  
P. 32



Permatex

+  
INFO  
INSTAL.  
P. 33



LOCTITE

+  
INFO  
INSTAL.  
P. 36

DF60, DF70

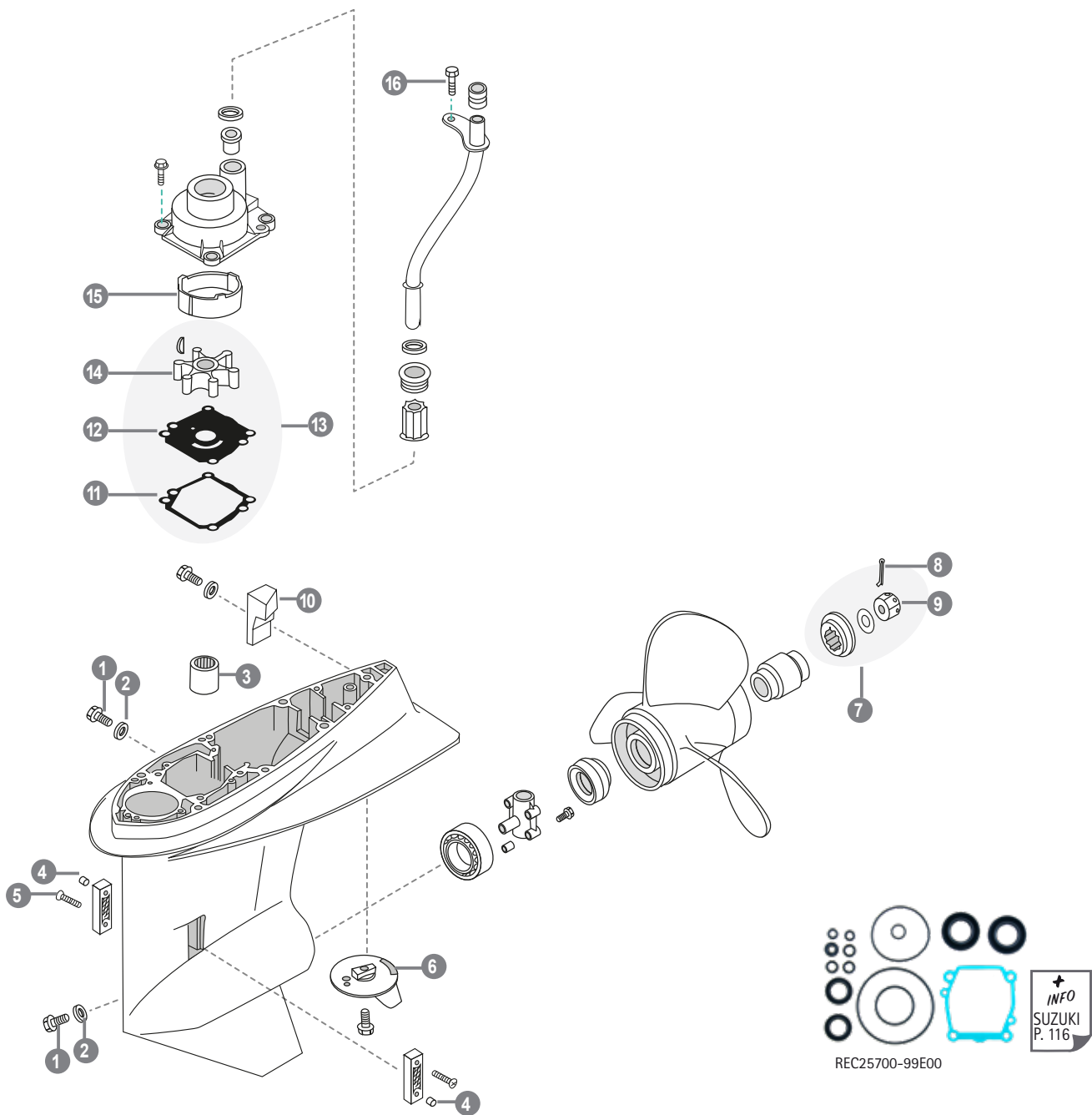

	REF	OEM				
1	REC09248-10008	09248-10008	SCREW 10x7,5	TORNILLO 10x7,5	VITE 10x7,5	VIS 10x7,5
2	REC09168-10022	09168-10022	CAP, O-RING	ARANDELA TAPÓN	RONDELLA TAPPO	JOINT DE VIDANGE
3	REC09263-26023	09263-26023	BEARING 26X34X30	COJINETE 26X34X30	CUSCINETTO 26X34X30	PALIER 26X34X30
4	PAGB/T889.1-M4	09140-04007	NUT HEXAGON M4	TUERCA HEXAGONAL M4	DADO ESAGONALE M4	ECROU HEXAGONAL M4
5	PAGB/T818-M4X30	09125-04023	SCREW PAN HEAD M4x30	TORNILLO M4x30	VITE TESTA M4x30	VIS M4x30
6	REC55125-90J01AL	55125-90J01	ANODE	ÁNODO	ANODO	ANODE
7	REC57630-94500	57630-94500	PROP NUT KIT	KIT CIERRE HELICE	KIT CHIUSURA ELICA	KIT ECROU D'HELICE
8	REC91490-30025	09204-03003	COTTER PIN	PIN BLOQUEADOR	COPPIGLIA	GOUPILLE
9	REC90171-18M04	09141-18005	NUT	TUERCA	DADO	ÉCROU
10	REC55321-90J01AL	55321-90J01	ANODE	ÁNODO	ANODO	ANODE
11	REC17472-87E10	17472-87E10	WATER PUMP GASKET	JUNTA BOMBA AGUA	GUARZIONE POMPA ACQUA	JOINT DE POMPE À EAU
12	REC17471-92J00	17471-87E01	PATE, WATER PUMP	PLACA BOMBA DE AGUA	PLACCA POMPA ACQUA	PLAQUE DE POMPE A EAU
13	REC17400-87E04	17400-87E03	WATER PUMP KIT	KIT REPARACION BOMBA AGUA	KIT RIPARAZIONE POMPA ACQUA	KIT TURBINE
14	REC17461-87E12	17461-87E12	IMPELLER	IMPULSOR	GIRANTE	TURBINE
15	REC17413-99E11	17413-99E10	INSERT CUP	CASQUILLO INOX	GHIERA INOX	INSERT INOX POMPE A EAU
16	PAGB/T5783-M6X16	09116-06225	BOLT HEXAGON M6x16	TORNILLO HEXAGONAL M6x16	BULLONE ESAGONALE M6x16	BOULON HEXAGONAL M6x16

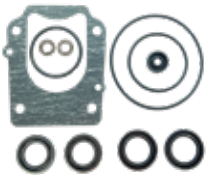
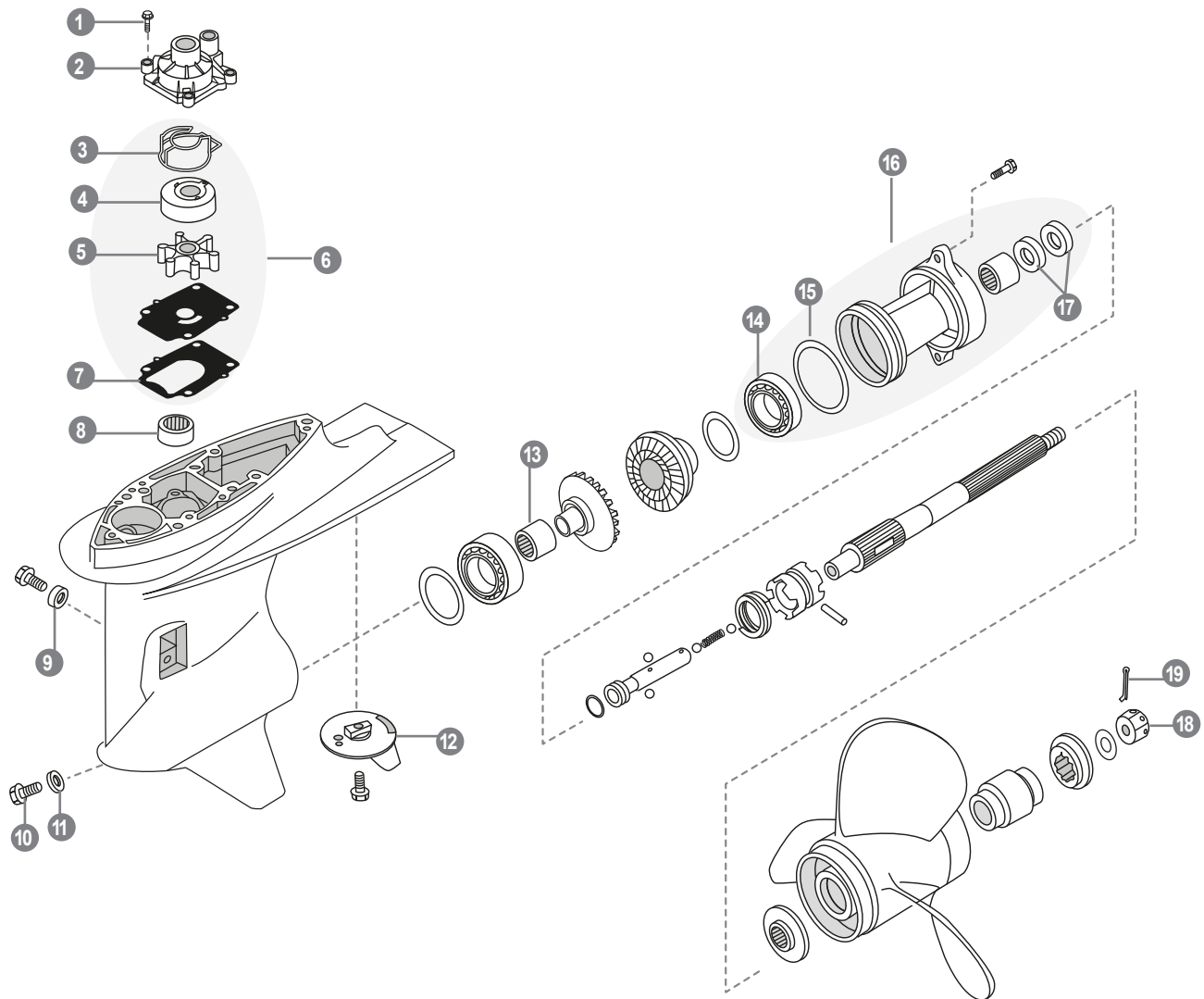

REC25700-87L00

REF	OEM					
1	PAF8-00000003	29116-93J10	BOLT M8x35	TORNILLO M8x35	BULLONE M8x35	BOULON M8x35
2	REC17410-99E10	17410-99E10	WATER PUMP COVER	CUERPO BOMBA AGUA	CORPO DELLA POMPA DELL'ACQUA	CARTER DE LA POMPE A EAU
3	REC17416-99E10	17416-99E10	O-RING	JUNTA TORICA	O-RING	JOINT TORIQUE
4	REC17413-99E11	17413-99E10	INSERT CUP	CASQUILLO INOX	GHIERA INOX	INSERT INOX POMPE A EAU
5	REC17461-87E12	17461-87E12	IMPELLER	IMPULSOR	GIRANTE	TURBINE
6	REC17400-87L01	17400-87L01	WATER PUMP KIT	KIT BOMBA DE AGUA	KIT POMPA ACQUA	KIT POMPE A EAU
7	REC17472-87L00	17472-87L00	WATER PUMP GASKET	JUNTA BOMBA AGUA	GUARZIONE POMPA ACQUA	JOINT DE POMPE À EAU
8	REC09263-26023	09263-26023	BEARING 26X34X30	COJINETE 26X34X30	CUSCINETTO 26X34X30	PALIER 26X34X30
9	REC55321-87J01AL	55321-87J00	ANODE	ÁNODO	ANODO	ANODE
10	REC09248-10008	09248-10008	SCREW 10x7,5	TORNILLO 10x7,5	VITE 10x7,5	VIS 10x7,5
11	REC09168-10034	09168-10034	GASKET	JUNTA	GUARNIZIONE	JOINT DE VIDANGE
12	REC55125-90J01AL	55125-90J01	ANODE	ÁNODO	ANODO	ANODE
13	REC09263-25067	09263-25067	BEARING	COJINETE	CUSCINETTO	PALIER
14	REC08113-60087	08113-60087	BEARING	COJINETE	CUSCINETTO	PALIER
15	REC09280-92004	09280-92004	O-RING	JUNTA TORICA	O-RING	JOINT TORIQUE
16	REC56120-87L30-0EP	56120-87L30-0EP	BEARING	DIABOLO	DIABOLO	DIABOLO
17	REC09282-25001	09282-25001	SEAL OIL	RETÉN	PARAOILIO	JOINT D'HUILE
18	REC90171-18M04	09141-18005	NUT	TUERCA	DADO	ECROU D'HELICE
19	REC91490-30025	09204-03003	COTTER PIN	PIN BLOQUEADOR	COPPIGLIA	GOUPILLE

A DF90, DF100, DF115

B DF140

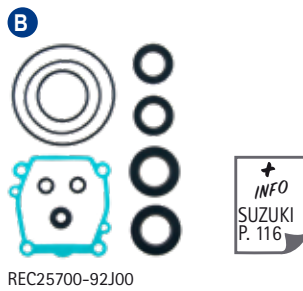
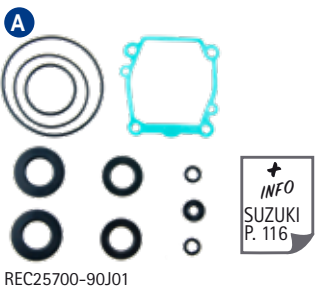
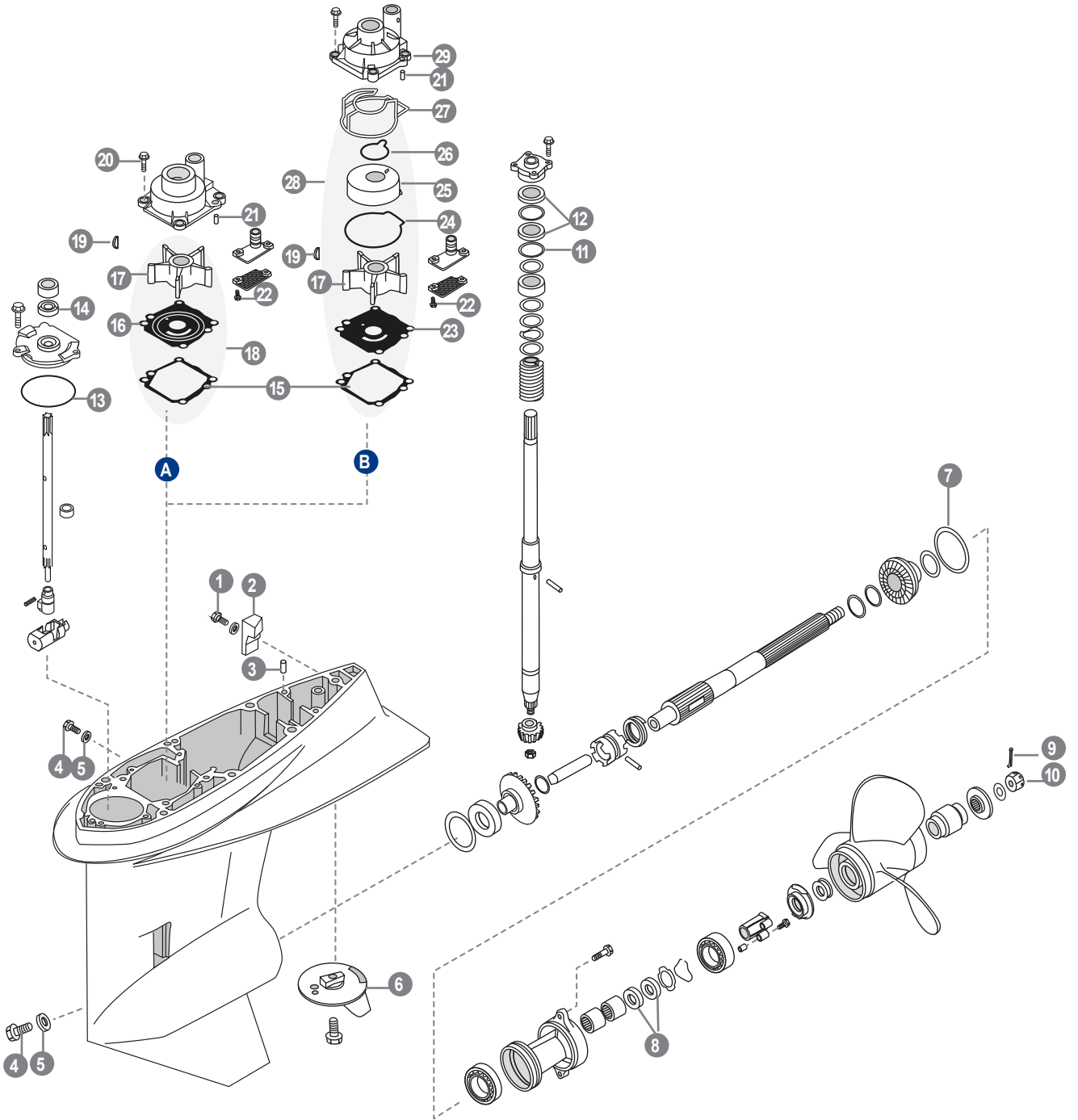

REF	OEM					
1	PAGB/T5783-M6X12	09100-06130	BOLT M6x12	TORNILLO M6x12	BULLONE M6x12	BOULON M6x12
2	REC55321-90J01AL	55321-90J01	ANODE	ÁNODO	ANODO	ANODE
3	PAF25-00000014	09202-08006	PIN, DOWEL F8x12	PIN CENTRADOR F8x12	PIN, CENTRAGGIO F8x12	GOUPILLE FENDUE 8x12
4	REC09248-10008	09248-10008	CAP, O-RING	ARANDELA TAPÓN	RONDELLA TAPPO	JOINT DE VIDANGE
5	REC09168-10022	09168-10022	SCREW 10x7,5	TORNILLO 10x7,5	VITE 10x7,5	VIS M10x7,5
6	REC55125-90J01AL	55125-90J01	ANODE	ÁNODO	ANODO	ANODE
7	REC09280-97001	09280-97001	O-RING 3.5 X 95 mm	ARO TORICO 3.5 X 95 mm	FASCIA TONDA 3.5 X 95 mm	TORIQUE 3.5 X 95 mm
8	REC09282-28002	09282-28002	OIL SEAL 28 X 50 X 6 mm	RETÉN 8 X 50 X 6 mm	PARAOLIO 8 X 50 X 6 mm	JOINT D'HUILE 8 X 50 X 6 mm
9	REC91490-30025	08204-03003	COTTER PIN	PIN BLOQUEADOR	COPPIGLIA	GOUPILLE
10	REC90171-18M04	09141-18005	NUT	TUERCA	DADO	ÉCROU
11	REC09280-46004	09280-46004	O-RING 3,5 X 45,7 mm	ARO TÓRICO 3,5 X 45,7 mm	FASCIA TONDA 3,5 X 45,7 mm	TORIQUE 3,5 X 45,7 mm
12	REC09282-24008	09282-24004	OIL SEAL 24 x 40 x 7 mm	RETÉN 24 x 40 x 7 mm	PARAOLIO 24 x 40 x 7 mm	JOINT D'HUILE 24 x 40 x 7 mm
13	REC09280-69001	09280-69001	O-RING 3.1 X 68.5 mm	ARO TÓRICO 3.1 X 68.5 mm	FASCIA TONDA 3.1 X 68.5 mm	TORIQUE 3.1 X 68.5 mm
14	REC09283-10011	09283-10011	OIL SEAL 10 X 22 X 8 mm	RETÉN 10 X 22 X 8 mm	PARAOLIO 10 X 22 X 8 mm	JOINT D'HUILE 10 X 22 X 8 mm
<b>A</b>			<b>OLDER MODELS</b>	<b>MODELOS ANTIGUOS</b>	<b>MODELLI VECCHIO</b>	<b>ANCIENS MODELES</b>
15	REC17472-87E10	17472-87E10	WATER PUMP GASKET	JUNTA BOMBA AGUA	GUARZIONE POMPA ACQUA	JOINT DE POMPE À EAU
16	REC17471-92J00	17471-92J00	OUTER PLATE CARTRIDGE	TAPA DEL IMPULSOR	COPERCHIO GIRANTE	PLAQUE DE POMPE À EAU
17	REC17461-90J01	17461-90J01	IMPELLER	IMPULSOR	GIRANTE	TURBINE
18	REC17400-90J20	17400-90J20	WATER PUMP KIT	KIT BOMBA DE AGUA	KIT POMPA ACQUA	KIT POMPE A EAU
19	REC09420-05009	09420-05009	KEY	CHAVETA	CHIAVETTA	CLAVETTE
20	PAGB/T5783-M8X25	09117-08057	BOLT M8X25	PERNO M8X25	BULLONE M8	BOULON M8X25
21	REC93606-12019	09202-06031	PIN F6X12	PIN F6X12	SPINOTTO F6X12	LEVIER F6X12
22	PAGB/T8.8-2000	09125-05046	SCREW, PAN HEAD M5X12	TORNILLO M5X12	VITE M5X12	VIS M5X12
<b>B</b>			<b>NEWER MODELS</b>	<b>MODELOS MODERNOS</b>	<b>MODELLI MODERNI</b>	<b>MODELES RECENTS</b>
23	REC17471-92J00	17471-92J00	OUTER PLATE CARTRIDGE	TAPA DEL IMPULSOR	COPERCHIO GIRANTE	PLAQUE DE POMPE À EAU
24	REC17416-92J00	17416-92J00	O-RING	JUNTA TORICA	O-RING	JOINT TORIQUE
25	REC17413-92J01	17416-92J01	INSERT CUP	CASQUILLO INOX	GHIERA INOX	INSERT INOX POMPE A EAU
26	REC17417-92J00	17417-92J00	O-RING	JUNTA TORICA	O-RING	JOINT TORIQUE
27	REC17416-92J10	17416-92J10	WATER PUMP, SEAL	TÓRICA BOMBA DE AGUA	FASCIA TONDA	JOINT TORIQUE
28	REC17400-92J21	17400-92J21	WATER PUMP KIT	KIT BOMBA DE AGUA	KIT POMPA ACQUA	KIT POMPE A EAU
29	REC17410-92J00	17410-92J00	WATER PUMP COVER	CUERPO BOMBA AGUA	CORPO DELLA POMPA DELL'ACQUA	CARTER DE LA POMPE A EAU



REC80W90U3  
REC80W90U6

**+**  
INFO  
INSTAL.  
P. 18



REGREU1  
REGREU12

**+**  
INFO  
INSTAL.  
P. 20



Permatex

**+**  
INFO  
INSTAL.  
P. 32



Permatex

**+**  
INFO  
INSTAL.  
P. 33



LOCTITE

**+**  
INFO  
INSTAL.  
P. 36

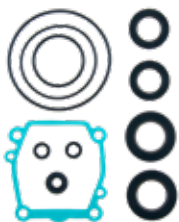
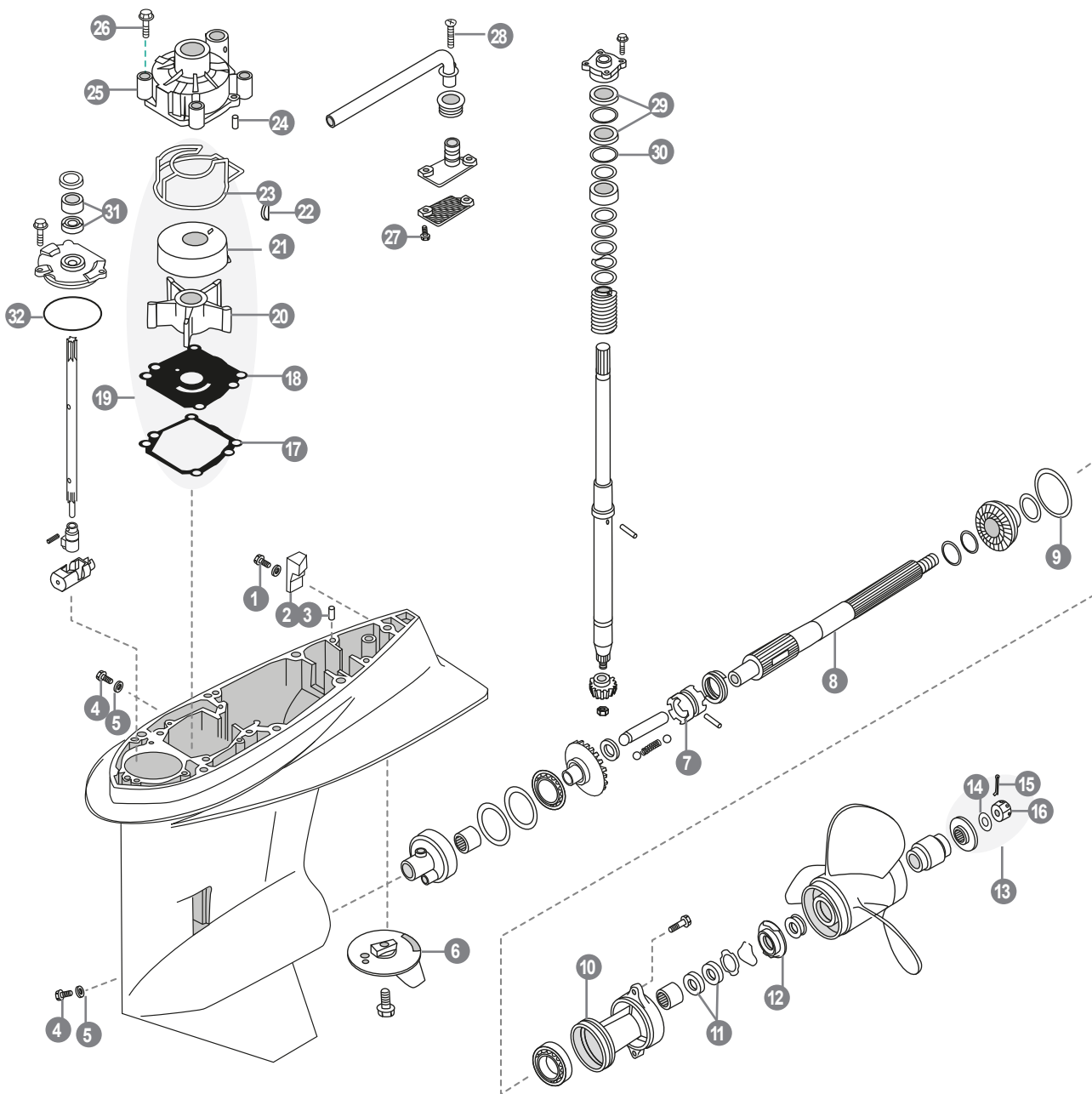

+  
 INFO  
 SUZUKI  
 P. 116

REC25700-92J00

	REF	OEM				
1	PAGB/T5783-M6X12	09100-06130	BOLT M6x12	TORNILLO M6x12	BULLONE M6x12	BOULON M6x12
2	REC55321-90J01AL	55321-90J01	ANODE	ÁNODO	ANODO	ANODE
3	PAF25-00000014	09202-08006	PIN, DOWEL F8x12	PIN CENTRADOR F8x12	PIN, CENTRAGGIO F8x12	GOUPILLE FENDUE 8x12
4	REC09248-10008	09248-10008	SCREW 10x7,5	TORNILLO 10x7,5	VITE 10x7,5	VIS 10x7,5
5	REC09168-10022	09168-10022	CAP, O-RING	ARANDELA TAPÓN	RONDELLA TAPPO	JOINT DE VIDANGE
6	REC55125-90J01AL	55125-90J01	ANODE	ÁNODO	ANODO	ANODE
7	REC57621-92J20	57621-92J20	CLUTCH DOG	DESPLAZABLE	SPOSTABILE	CRABOT
8	REC57610-92J20	57610-92J20	PROP SHAFT	EJE DE HELICE	ASSE ELICA	ARBRE D'HELICE
9	REC09280-97001	09280-97001	O-RING	ARO TÓRICO	FASCIA TONDA	TORIQUE
10	REC56120-92J01-OEP	56120-92L01-OEP	BEARING	DIABOLO	DIABOLO	DIABOLO
11	REC09282-30007	09282-30007	SEAL OIL	RETÉN	PARAOLIO	JOINT D'HUILE
12	REC57633-90J02	57633-90J02	SPACER	ESPACIADOR	DISTANZIALE	CALE
13	REC57630-90J00	57630-90J00	PROP THRUST WASHER	KIT TOPE HELICE	KIT FERMO PER ELICA	RONDELLE D'HELICE
14	REC09160-18028	09160-18028	WASHER	ARANDEL	RONDELLA	RONDELLE
15	REC91490-30025	09240-03003	COTTER PIN	PIN BLOQUEADOR	COPPIGLIA	GOUPILLE
16	REC90171-18M04	09141-18005	NUT	TUERCA	DADO	ÉCROU
17	REC17472-87E10	17472-87E10	WATER PUMP GASKET	JUNTA BOMBA AGUA	GUARZIONE POMPA ACQUA	JOINT DE POMPE À EAU
18	REC17471-92J00	17471-92J00	OUTER PLATE CARTRIDGE	TAPA DEL IMPULSOR	COPERCHIO GIRANTE	PLAQUE DE POMPE À EAU
19	REC17400-92J21	17400-92J21	WATER PUMP KIT	KIT BOMBA DE AGUA	KIT POMPA ACQUA	KIT POMPE A EAU
20	REC17461-90J01	17461-90J01	IMPELLER	IMPULSOR	GIRANTE	TURBINE
21	REC17413-92J01	17413-92J01	INSERT CUP	CASQUILLO INOX	GHIERA INOX	INSERT INOX POMPE A EAU
22	REC09420-05009	09420-05009	KEY	CHAVETA	CHIAVETTA	CLAVETTE
23	REC17416-92J10	17416-92J10	WATER PUMP, SEAL	TÓRICA BOMBA DE AGUA	FASCIA TONDA	JOINT TORIQUE
24	REC93606-12019	09202-06031	PIN F6X12	PIN F6X12	SPINOTTO F6X12	LEVIER F6X12
25	REC17400-92J00	17400-92J00	WATER PUMP REPAIR KIT	KIT REPARACION BOMBA AGUA	KIT POMPA ACQUA	KIT REPARATION POMPE A EAU
26	REC09116-08131	09116-08131	SCREW	TORNILLO	VITE	VIS
27	PAGB/T8.8-2000	09125-05046	SCREW, PAN HEAD M5X12	TORNILLO M5X12	VITE M5X12	VIS M5X12
28	PAGB/T818-M6X10	09125-06063	BOLT M6x10	TORNILLO M6x10	BULLONE M6x10	BOULON M6x10
29	REC09282-24008	09282-24004	SEAL OIL	RETÉN	PARAOLIO	JOINT D'HUILE
30	REC09280-46004	09280-46004	O-RING	ARO TÓRICO	FASCIA TONDA	TORIQUE
31	REC09283-10011	09283-10011	SEAL OIL	RETÉN	PARAOLIO	JOINT D'HUILE
32	REC09280-69001	09280-69001	O-RING	ARO TÓRICO	FASCIA TONDA	TORIQUE



REC80W90U3  
REC80W90U6

**+**  
INFO  
INSTAL.  
P. 18



REGREU1  
REGREU12

**+**  
INFO  
INSTAL.  
P. 20



**+**  
INFO  
INSTAL.  
P. 32



**+**  
INFO  
INSTAL.  
P. 33



**+**  
INFO  
INSTAL.  
P. 36

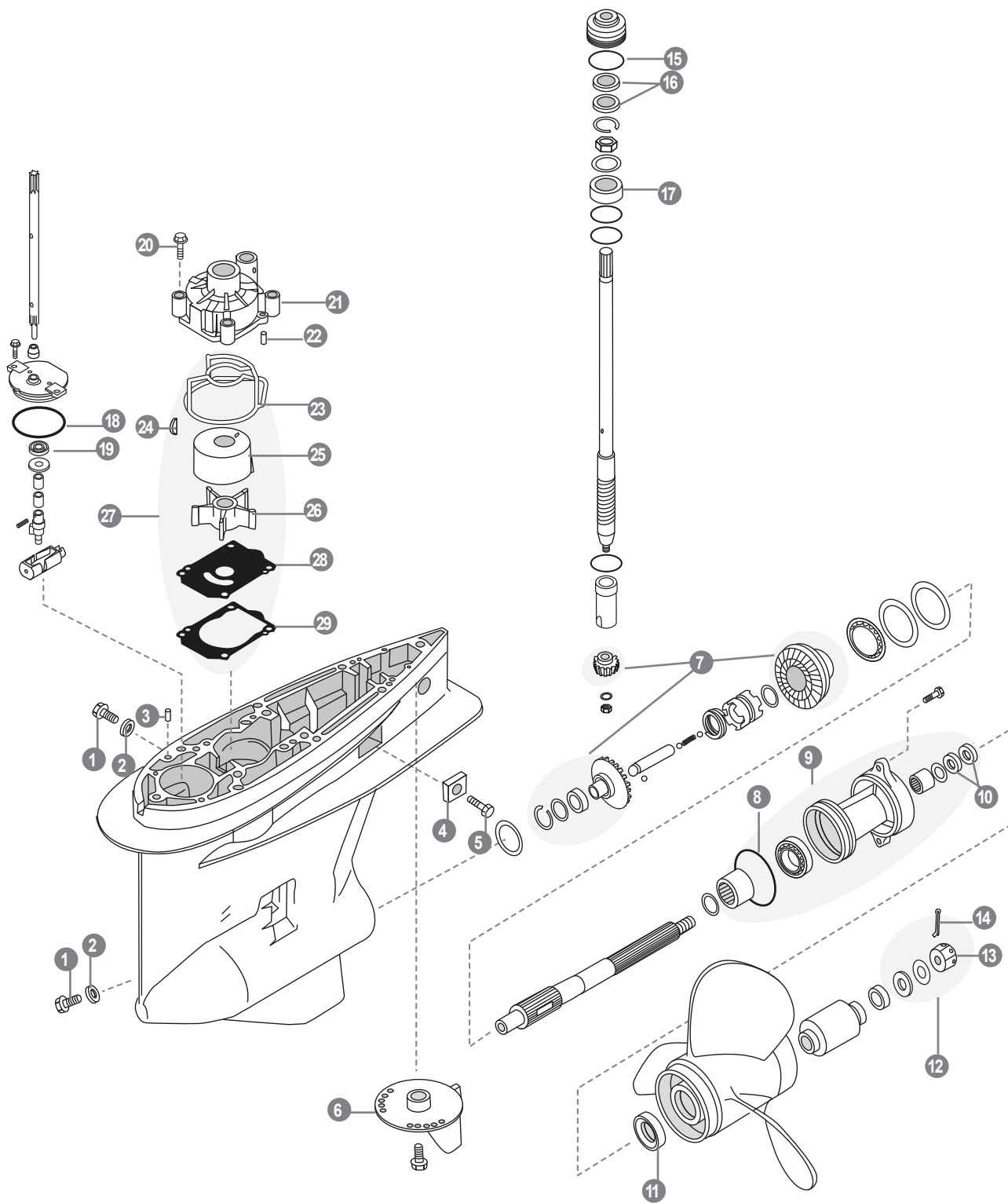

INFO  
SUZUKI  
P. 116

REC25700-93J00

	REF	OEM				
1	REC55128-93J10	55128-93J10	WATER PLUG DRAIN	TAPON DRENAJE COLA	GUARNIZIONE DRENAGGIO	BOUCHON DE VIDANGE
2	REC09168-10034	09168-10034	GASKET	JUNTA	GUARNIZIONE	JOINT
3	PAF25-00000014	09202-08006	PIN, DOWEL F8x12	PIN CENTRADOR F8x12	PIN, CENTRAGGIO F8x12	GOUPILLE FENDUE 8x12
4	REC55320-95311AL	55320-95311	ANODE	ÁNODO	ANODO	ANODE
5	REC09116-06094	09116-06094	SCREW 6x15	TORNILLO 6x15	VITE 6x15	VIS M6x15
6	REC55125-90J01AL	55125-98J00	ANODE	ÁNODO	ANODO	ANODE
7	REC57300-96810	57300-96810	GEAR KIT	KIT PIÑONES	KIT PIGNONI	KIT DE PIGNONS
	REC57300-96850	57300-96850	GEAR KIT DF200A	KIT PIÑONES DF200A	KIT PIGNONI DF200A	KIT DE PIGNONS DF200A
8	REC09280-00040	09280-00040	O-RING	JUNTA TORICA	FASCIA TONDA	JOINT TORIQUE
9	REC56120-93J50-0EP	6120-93J50-0EP	HOUSING,PROP SHAFT BRG	SOPORTE DE EJE DE HELICE	ALLOGGIAMENTO, CUSCINETTO DELL'ALBERO DE	CARTER, PALIER D'ARBRE D'HELICE
10	REC09282-30006	09282-30006	SEAL OIL	RETÉN	PARAOLIO	JOINT D'HUILE
11	REC57632-93L01	57632-93L01	BUMP STOP	TOPE	FERMO	BUTÉE
12	REC57630-92E00	57630-92E00	PROP NUT KIT	KIT CIERRE HELICE	KIT CHIUSURA ELICA	KIT ECROU D'HELICE
13	REC90171-18M04	09141-18005	NUT	TUERCA	DADO	ÉCROU
14	REC91490-30025	09204-03003	COTTER PIN	PIN BLOQUEADOR	COPPIGLIA	GOUPILLE
15	REC09280-66004	09280-66004	O-RING	JUNTA TORICA	FASCIA TONDA	JOINT TORIQUE
16	REC09282-24008	09282-24004	SEAL OIL	RETÉN	PARAOLIO	JOINT D'HUILE
17	REC09269-32002	09269-32002	BEARING 32X66X49 DF300A	COJINETE 32X66X49 DF300A	CUSCINETTO 32X66X49 DF300A	PALIER 32X66X49 DF300A
18	REC09280-60007	09280-60007	O-RING	JUNTA TORICA	FASCIA TONDA	JOINT TORIQUE
19	REC09282-08005	09282-08005	SEAL OIL	RETÉN	PARAOLIO	JOINT D'HUILE
20	REC09116-08131	09116-08131	SCREW	TORNILLO	VITE	VIS
21	REC17411-96J01	17411-96J01	WATER PUMP COVER	CUERPO BOMBA AGUA	CORPO DELLA POMPA DELL'ACQUA	CARTER DE LA POMPE A EAU
22	REC93606-12019	09202-06031	PIN F6X12	PIN F6X12	SPINOTTO F6X12	LEVIER F6X12
23	REC17416-96J00	17416-96J00	O-RING	JUNTA TORICA	FASCIA TONDA	JOINT TORIQUE
24	REC09420-05009	09420-05009	KEY	CHAVETA	CHIAVETTA	CLAVETTE
25	REC17413-96J01	17413-96J01	SLEEVE WATER PUMP	CASQUILLO INOX	CAPPUCCIO	INSERT DE POMPE À EAU
26	REC17461-90J01	17461-90J01	IMPELLER	IMPULSOR	GIRANTE	TURBINE
27	REC17400-96J03	17400-96J03	WATER PUMP KIT	KIT BOMBA DE AGUA	KIT POMPA ACQUA	KIT POMPE A EAU
28	REC17471-92J02	17471-93J02	IMPELLER PLATE	TAPA DEL IMPULSOR	COPERCHIO GIRANTE	PLAQUE DE POMPE À EAU
29	REC17472-93J00	17472-93J00	GASKET	JUNTA	GUARNIZIONE	JOINT



REC80W90U3  
REC80W90U6

**+**  
INFO  
INSTAL.  
P. 18



REGREU1  
REGREU12

**+**  
INFO  
INSTAL.  
P. 20



Permatex

**+**  
INFO  
INSTAL.  
P. 32



Permatex

**+**  
INFO  
INSTAL.  
P. 33



LOCTITE

**+**  
INFO  
INSTAL.  
P. 36

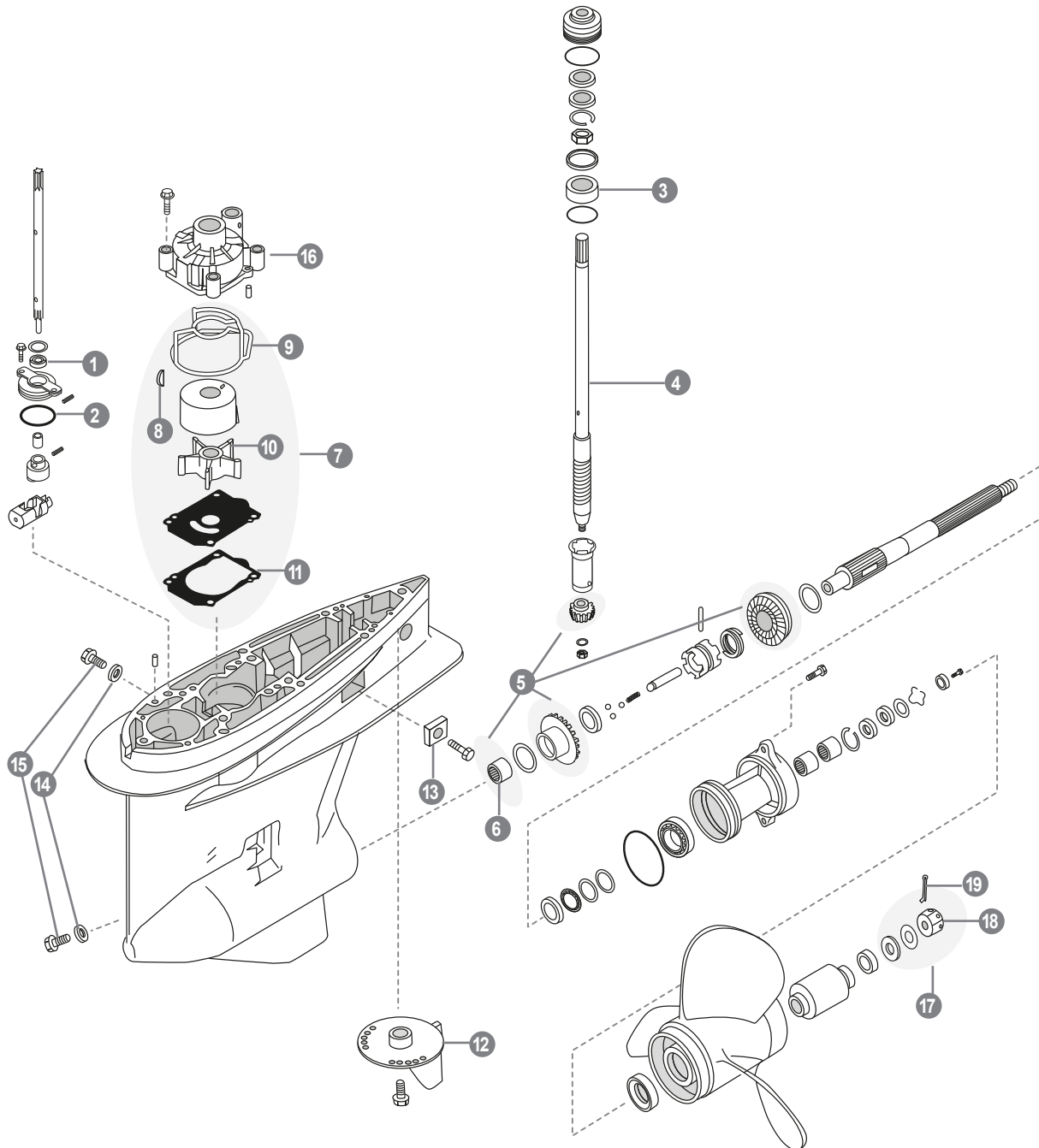

REF	OEM					
1	REC09283-10011	09283-10011	SEAL OIL	RETÉN	PARAOLIO	JOINT D'HUILE
2	REC09280-40019	09280-40019	O-RING	JUNTA TORICA	FASCIA TONDA	JOINT TORIQUE
3	REC09269-32002	09269-32002	BEARING 32X66X49 DF300A	COJINETE 32X66X49 DF300A	CUSCINETTO 32X66X49 DF300A	PALIER 32X66X49 DF300A
4	REC57110-93J21	57110-93J21	SHAFT X 25"	EJE X 25"	ASSE X 25"	ARBRE X 25"
5	REC57110-93J31	57110-93J31	SHAFT XX 25"	EJE XX 25"	ASSE XX 30"	ARBRE XX 30"
6	REC57300-93860	57300-93860	DF200T/K14 GEAR KIT	KIT PIÑONES DF200T/K14	KIT PIGNONI DF200T/K14	KIT DE PIGNONS DF200T/K14
7	REC09263-25067	09263-25067	BEARING	COJINETE	CUSCINETTO	ROULEMENT
8	REC17400-93J01	17400-93J01	WATER PUMP KIT	KIT BOMBA DE AGUA	KIT POMPA ACQUA	KIT POMPE A EAU
9	REC09420-05009	09420-05009	KEY	CHAVETA	CHIAVETTA	CLAVETTE
10	REC17416-93J00	17416-93J00	WATER PUMP, SEAL	TÓRICA BOMBA DE AGUA	FASCIA TONDA	JOINT TORIQUE
11	REC17461-93J00	17461-93J00	IMPELLER	IMPULSOR	GIRANTE	TURBINE
12	REC17472-93J00	17472-93J00	CASE PANEL GASKET	JUNTA BASE POMBA	GUARNIZIONE BASE POMPA	JOINT DE BASE
13	REC55125-90J01AL	55125-90J01	ANODE	ÁNODO	ANODO	ANODE
14	REC55320-95311AL	55320-95311	ANODE	ÁNODO	ANODO	ANODE
15	REC09168-10034	09168-10034	GASKET	JUNTA	GUARNIZIONE	JOINT
16	REC55128-93J10	55128-93J10	WATER PLUG DRAIN	TAPON DRENAJE COLA	GUARNIZIONE DRENAGGIO	BOUCHON DE VIDANGE D'EMBASE
17	REC17410-93J01	17410-93J01	WATER PUMP COVER	CUERPO BOMBA AGUA	CORPO DELLA POMPA DELL'ACQUA	CARTER DE LA POMPE A EAU
18	REC57630-92E00	57630-92E00	PROP NUT KIT	KIT CIERRE HELICE	KIT CHIUSURA ELICA	KIT ECROU D'HELICE
19	REC90171-18M04	90171-18M04	NUT	TUERCA	DADO	ÉCROU
19	REC91490-30025	91490-30025	COTTER PIN	PIN BLOQUEADOR	COPPIGLIA	GOUPILLE

DF250AP, DF300AP



REC25700-93L00

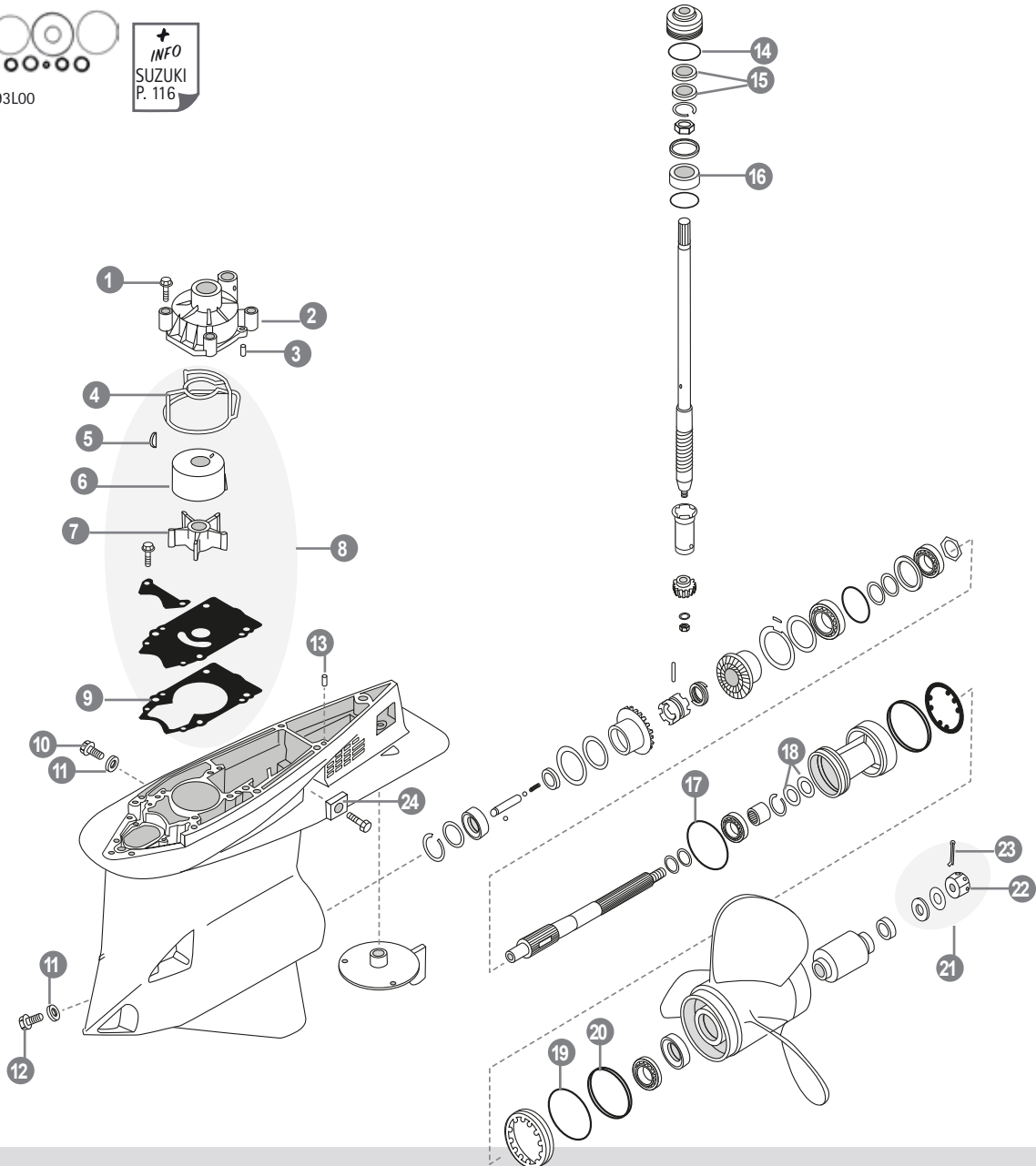

REF	OEM					
1	REC09116-08131	09116-08131	SCREW	TORNILLO	VITE	VIS
2	REC17410-93J01	17410-93J01	WATER PUMP COVER	CUERPO BOMBA AGUA	CORPO DELLA POMPA DELL'ACQUA	CARTER DE LA POMPE A EAU
3	REC93606-12019	09202-06031	PIN F6X12	PIN F6X12	SPINOTTO F6X12	LEVIER F6X12
4	REC17416-93J00	17416-93J00	WATER PUMP, SEAL	TÓRICA BOMBA DE AGUA	FASCIA TONDA	JOINT TORIQUE
5	REC09420-05009	09420-05009	KEY	CHAVETA	CHIAVETTA	CLAVETTE
6	REC17413-93J02	17413-93J02	INSERT	CASQUILLO	INSERIMENTO	DOUILLE
7	REC17461-93J00	17461-93J00	IMPELLER	IMPULSOR	GIRANTE	TURBINE
8	REC17400-98J01	17400-98J01	WATER PUMP KIT	KIT BOMBA DE AGUA	KIT POMPA ACQUA	KIT POMPE A EAU
9	REC17472-98J00	17472-98J00	CASE PANEL GASKET	JUNTA BASE BOMBA	GUARNIZIONE BASE POMPA	JOINT DE BASE
10	REC55128-93J10	55128-93J10	WATER PLUG DRAIN	TAPON DRENAJE COLA	GUARNIZIONE DRENAGGIO	BOUCHON DE VIDANGE D'EMBASE
11	REC09168-10034	09168-10034	GASKET	JUNTA	GUARNIZIONE	JOINT
12	REC55128-93L00	55128-93L00	WATER PLUG DRAIN WITH GASKET	TAPON CON JUNTA	TAPPO DI SCARICO CON GUARNIZIONE	BOUCHON DE VIDANGE AVEC JOINT
13	PAF25-00000014	09202-08006	PIN, DOWEL F8x12	PIN CENTRADOR F8x12	PIN, CENTRAGGIO F8x12	GOUILLE FENDUE 8x12
14	REC09280-66004	09280-66004	O-RING	JUNTA TORICA	FASCIA TONDA	JOINT TORIQUE
15	REC09282-24008	09282-24004	SEAL OIL	RETÉN	PARAOLIO	JOINT D'HUILE
16	REC09269-32002	09269-32002	BEARING 32X66X49 DF300A	COJINETE 32X66X49 DF300A	CUSCINETTO 32X66X49 DF300A	PALIER 32X66X49 DF300A
17	REC09280-00047	09280-00047	O-RING	JUNTA TORICA	FASCIA TONDA	JOINT TORIQUE
18	REC09282-30006	09282-30006	SEAL OIL	RETÉN	PARAOLIO	JOINT D'HUILE
19	REC09280-00050	09280-00050	O-RING	JUNTA TORICA	FASCIA TONDA	JOINT TORIQUE
20	REC56129-93L00	56129-93L00	BUSHING	CASQUILLO	GHIERA	MANCHON
21	REC57630-92E00	57630-92E00	PROP NUT KIT	KIT CIERRE HELICE	KIT CHIUSURA ELICA	KIT ECROU D'HELICE
22	REC90171-18M04	90171-18M04	NUT	TUERCA	DADO	ÉCROU
23	REC91490-30025	09204-03003	COTTER PIN	PIN BLOQUEADOR	COPPIGLIA	GOUILLE
24	REC55320-95311AL	55320-95311	ANODE	ÁNODO	ANODO	ANODE

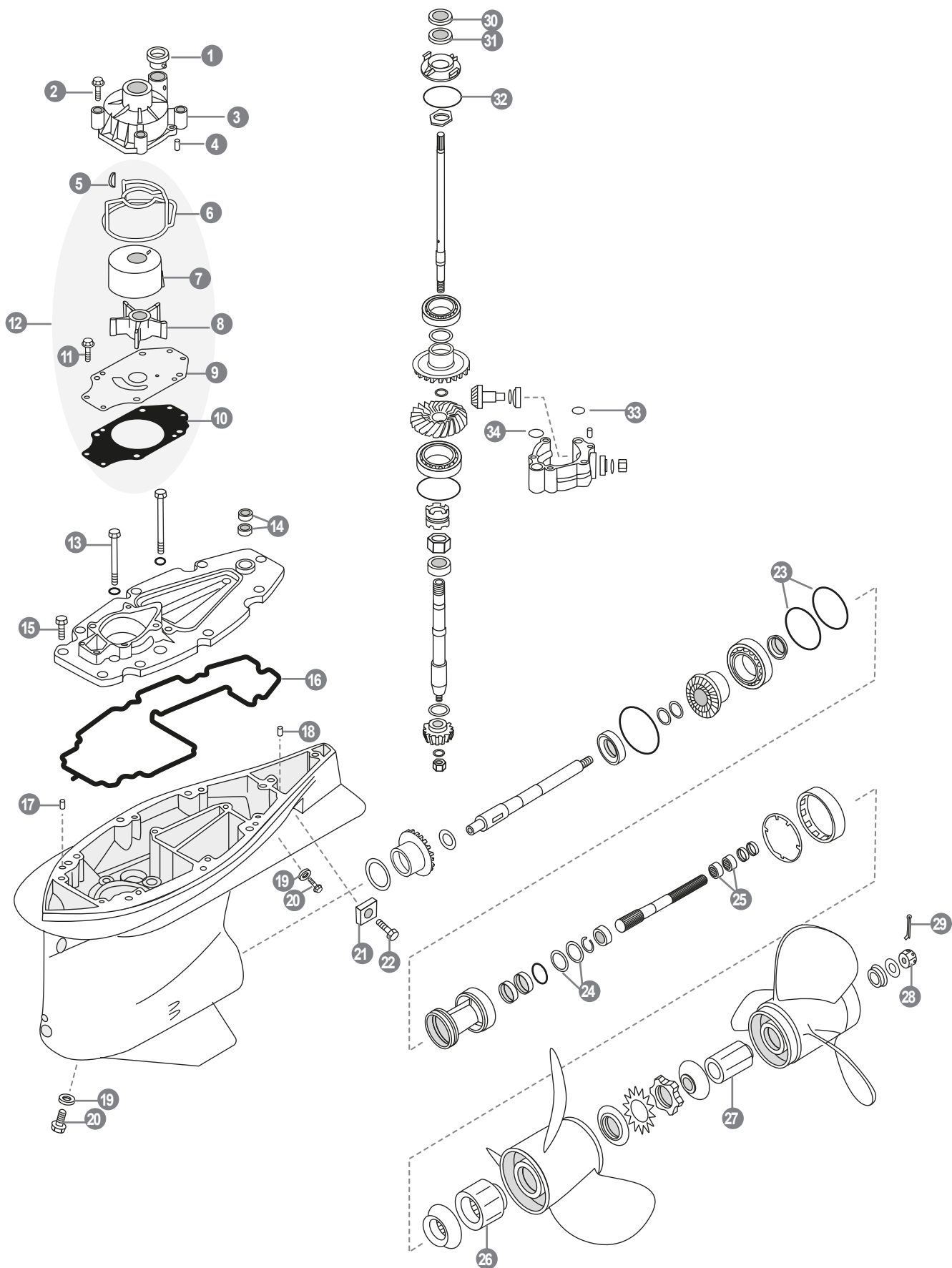

	REF	OEM				
1	REC17564-93J01	17564-93J01	BUSH WATER PUMP CASE	ADAPTADOR BOMBA AGUA	ADATTATORE POMPA ACQUA	ADAPTATEUR DE POMPE À EAU
2	REC90119-08M14	90119-08M14	SCREW	TORNILLO	VITE	VIS
3	REC17410-93J01	17410-93J01	WATER PUMP COVER	CUERPO BOMBA AGUA	CORPO DELLA POMPA DELL'ACQUA	CARTER DE LA POMPE A EAU
4	REC93606-12019	93606-12019	PIN DOWEL	PIN CENTRADOR	PIN DOWEL	CLAVETTE DE CENTRAGE
5	REC09420-05009	09420-05009	KEY	CHAVETA IMPELLER	CHIUSURA	CLAVETTE TURBINE
6	REC17416-93J00	17416-93J00	O-RING	JUNTA TORICA	FASCIA TONDA	JOINT TORIQUE
7	REC17413-93J02	17413-93J02	INSERT	CASQUILLO	INSERIMENTO	DOUILLE
8	REC17461-93J00	17461-93J00	IMPELLER	IMPULSOR	GIRANTE	TURBINE
9	REC17471-98L00	17471-98L00	OUTER PLATE CARTRIDGE	TAPA IMPULSOR	COPERCHIO GIRANTE	COUVERCLE DE TURBINE
10	REC17472-98L00	17472-98L00	WATER PUMP GASKET	JUNTA BOMBA DE AGUA	GUARNIZIONE DELLA POMPA DELL'ACQUA	JOINT DE POMPE À EAU
11	PAGB/T5787-M6X20	29116-93J00	SCREW	TORNILLO	VITE	VIS
12	REC17400-98L03	17400-98L03	WATER PUMP REPAIR KIT	KIT REPARACION BOMBA AGUA	KIT POMPA ACQUA	KIT REPARATION POMPE A EAU
13	PAGB/T5782-M8X105		BOLT M8X105	TORNILLO M8X105	BULLONE M8X105	BOULON M8X105
14	REC09282-15010	09282-15010	SEAL OIL	RETÉN	PARAOLIO	JOINT D'HUILE
15	PAF8-00000003	09116-08114 29116-93J10	BOLT M8X35	TORNILLO M8X35	BULLONE M8X35	BOULON M8X35
16	REC55122-98L00	55122-98L00	GASKET	JUNTA	GUARNIZIONE	JOINT
17	PAF25-00000014	09202-08006	CENTERING PIN F8X12	PASADOR DE CENTRADO F8X12	PIN, CENTRAGGIO F8X12	GOUPILLE FENDUE 8X12
18	REC93606-12019	93606-12019	PIN, DOWEL	PIN CENTRADOR	PIN, CENTRAGGIO	GOUPILLE FENDUE
19	REC09168-10034	09168-10034	DRAIN PLUG GASKET	JUNTA DRENAJE	GUARNIZIONE DRENAGGIO	JOINT DE VIDANGE D'EMBASE
20	REC55128-93L00	55128-93L00	WATER PLUG DRAIN WITH GASKET	TAPON CON JUNTA	TAPPO DI SCARICO CON GUARNIZIONE	BOUCHON DE VIDANGE AVEC JOINT
21	REC55320-95311AL	55320-95311AL	ANODE	ANODO	ANODO	ANODE
22	PAGB/T5783-M6X16	09116-06094 09116-06225	BOLT HEXAGON M6X16	TORNILLO HEXAGONAL M6X16	BULLONE ESAGONALE M6X16	BOULON HEXAGONAL M6X16
23	REC09280-00047	09280-00047	O-RING	JUNTA TORICA	FASCIA TONDA	JOINT TORIQUE
24	REC09282-45001	09282-45001	SEAL OIL	RETÉN	PARAOLIO	JOINT D'HUILE
25	REC09282-30009	09282-30009	SEAL OIL	RETÉN	PARAOLIO	JOINT D'HUILE
26	SOL17047301	58520-98L00	PROPELLER HUB FRONT	NUCLEO HELICE FRONT	MOZZO ELICA ANTERIORE	MOYEU D'HELICE AVANT
27	SOL17047302	58620-98L00	PROPELLER HUB REAR	NUCLEO HELICE TRASERO	MOZZO ELICA POSTERIORE	MOYEU D'HELICE ARRIERE
28	REC90171-18M04	90171-18M04	NUT	TUERCA	DADO	ÉCROU
29	REC91490-30025	91490-30025	PIN	PASADOR	FERMO	GOUPILLE
30	REC09282-24008	09282-24008	SEAL OIL	RETÉN	PARAOLIO	JOINT D'HUILE
31	REC09289-24002	09289-24002	SEAL OIL	RETÉN	PARAOLIO	JOINT D'HUILE
32	REC09280-69001	09280-69001	O-RING	JUNTA TORICA	FASCIA TONDA	JOINT TORIQUE
33	REC09280-21015	09280-21015	O-RING	JUNTA TORICA	FASCIA TONDA	JOINT TORIQUE
34	REC09280-26006	09280-26006	O-RING	JUNTA TORICA	FASCIA TONDA	JOINT TORIQUE

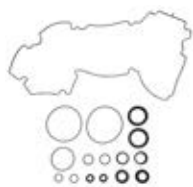

REC25700-98L04



REC80W90U3  
REC80W90U6

**+**  
INFO  
INSTAL.  
P. 18



REGREU1  
REGREU12

**+**  
INFO  
INSTAL.  
P. 20



Permatex

**+**  
INFO  
INSTAL.  
P. 32



Permatex

**+**  
INFO  
INSTAL.  
P. 33



LOCTITE

**+**  
INFO  
INSTAL.  
P. 36

TOOL

HERRAMIENTA

ATREZZI

OUTIL

RETAINING RING WRENCH

HERRAMIENTA TUERCA DIABOLO

ATTREZO DADO DIABOLO

OUTIL ÉCROU DIABOLO

REF	PART NUMBER	YAMAHA RING	MERCURY RING	SUZUKI RING	HONDA RING	TOOTH NUMBER	Ø (mm)
RECTOOL3	697-45384-02	61B-45384-00	11-87763/9		41109-ZV5-000	12	69
	61B-45384-00					12	87
RECTOOL4	688-45384-02						
RECTOOL5	6G5-45384-20/02	8M0168885	8M02011027	56122-93L00		12	94
	65N-45384-00	79448	54163				
RECTOOL2	RECTOOL6	8M0001491	8M0111653	8M0162798		16	109
RECTOOL7	6AW-45384-00					12	104
RECTOOL8	664-45384-00					4	61
RECTOOL9	6CB-45384-00					12	99
RECTOOL10		8661122		56122-87E00		12	83



RECTOOL2



RECTOOL3



RECTOOL4



RECTOOL5



RECTOOL6



RECTOOL7



RECTOOL8



RECTOOL9



RECTOOL10

DRIVE COMPONENTS

COMPONENTES DE COLA

COMPONENTI PIEDI

PIECES D' EMBASES

STERN DRIVE COMPONENTS GUIDE

KITS JUNTAS Y RETENES

KIT GUARNIZIONE E TENUTE

KITS JOINTS D'EMBASES

REF	OEM	
1 REC25700-95J00	25700-95J00	DF20R, DF25, DF25R-V2 (2006-11)
2 REC25700-95D01	25700-95D00/1	DF25, DF30Y-K6 (2000-06) DT25C, DT30C-K-Y (1989-00)
3 REC25700-88L00	25700-94400 25700-88400	DF40, DF50X-K10 (1999-10) DF40A, DF50A, DF60A (2010+)
4 REC25700-99E00	25700-99E00	DF40A, DF50A, DF60A (2014+) DF60, DF70W-K9 (1998-09)
5 REC25700-87L00	25700-87L00	DF70A, DF80A, DF90A (2009+)
6 REC25700-90J01	25700-90J01	DF90, DF100, DF115 K1-K11 (2001-11) DF115WT, DF140WT-K3 (2003)
7 REC25700-92J00	25700-92J00	DF100A, DF115A, DF140A (2013+) DF140 (2002-12)
8 REC25700-93J00	25700-93J00	DF150, DF175T/Z (G) (2006-14) DF200, DF225, DF250 (2004+) DF200A (2015)
9 REC25700-93L00	25700-93L00	DF250AP, DF300AP
10 REC25700-98J00	25700-98J00	DF300T/Z (2007-11)
11 REC25700-98L04	25700-98L01/2/4/5	DF350A, DF325A, DF300B (2019+)

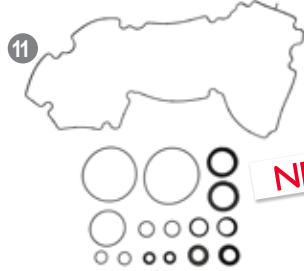
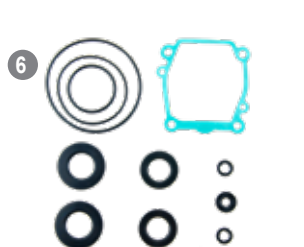
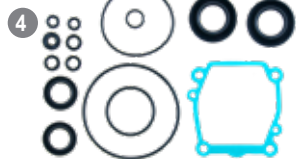
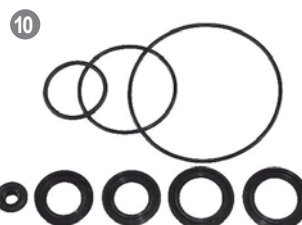
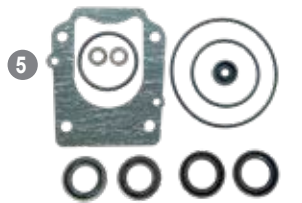
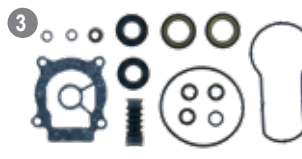
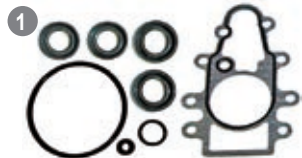
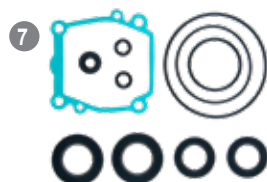

GUIDE OF GASKETS KITS	GUÍA KITS DE JUNTAS	GUIDA KIT GUARNIZIONE	GUIDE DES KITS JOINTS
	REF		REF
DT25C, DT30C	REC25700-95D01	DF60, DF70 V4 (1989-00)	
DT55, DT65		DF60, DF70 (2001-10)	REC25700-99E00
DT75, DT85	REC25700-95501	DF70A, DF80A, DF90A (2009+)	REC25700-87L00
DT115, DT140		DF90, DF100, DF115	REC25700-90J01
V6 2-STROKE (1989-03)		DF115A	REC25700-92J00
DF25, DF30 V-TWIN	REC25700-95D01	DF140	REC25700-93J00
DF25 V-TWIN	REC25700-95J00	DF150, DF175, DF200, DF225, DF250	REC25700-98J00
DT40C		DF250SS	REC25700-98J00
DF40, DF50	REC25700-88L00	DF300	REC25700-93L00
DF40A, DF50A, DF60A		DF250AP, DF300AP	

SHIFT, BELOW	FUELLES VARILLA DE CAMBIO	MANICOTTO MARCE	SOUFFLET DU LEVIER DE CHANGEMENT DE VITESSE
REF	OEM		
1 REC25222-93901	25222-93901	1 	2 
2 REC25222-96300	25222-96300		
	DF4, DF5, DF6 (2002-12)		
	DF9.9, DF15 (1996-12)		
	DT7, DT5 (1988-01)		
	DT9.9, DT15 (1986-04)		
	DF25, DF30 Y-K6 (2000-06)		
	DT20, T25, DT30 (1986-02)		
	DT40C-W G-X (1986-99)		

SHIFT, O-RING	ARO TÓRICO VARILLA DE CAMBIO	O-RING MARCE	JOINT TORIQUE DU LEVIER
REF	OEM		
REC09280-08005	09280-08005 1,8 x 7.7 mm	1 	
	DF20R, DF25RVZ (2006-13)		
	DF25, DF30Y-K6 (2000-06)		
	DF40, DF50X-K10 (1999-10)		
	DF40A, DF50A, DF60A (2010+)		
	DT20, DT25, DT30G-Y (1986-00)		
	DT25, DT30 K1-K2 (2001-02)		
	DT40C-W G-X (1986-99)		
	DT55, DT60J-Z (1988-99)		
	DT75, DT85J-Y (1988-00)		

TURNBUCKE, CLUTCH ROD	TUERCA,VARILLA DE CAMBIO	DADO ASTA CAMBIO	ECROU DU LEVIER DE CHANGEMENT DE VITESSE
REF	OEM		
REC61N-44146-00	23311-95DLO	1 	
	DF25, DF30Y-K6 (2000-06)		
	DF40, DF50X-K10 (1999-10)		
	DF9.9, DF15T-K3 (1996-03)		
	DF9.9, DF15 (R) (2004-11)		
	DT9.9, DT40		

SHAFT	EJE TRANSMISON	ASSE	ARBRE
REF	OEM		
REC57110-93J31	57110-93J30/31	1 	
	DF200, DF225, DF250 (2017+)		
	30" XX		

DRAIN, SCREW AND GASKETS	TORNILLOS Y JUNTAS DE DRENAJE	VITI E GUARNIZIONE, DRENAGGIO	VIS ET JOINTS DE VIDANGE
REF	OEM		
1 REC59178-97J00	59178-97J00	1 	1 
2 REC09168-10022	09168-10022	1 	2 
2 REC09168-10022BULK		100 10 x 17 x 1.5 mm	
3 REC09168-10034	09168-10034	1	3 
3 REC09168-10034BULK		50	4 
4 REC09248-10008	09248-10008	1 10 x 7.2 mm	5 
5 REC55128-93J10	55128-93J00/10	1	6 
6 REC55128-93L00	55128-93L00	1	

DRAIN EATER TUBE		TUBO DRENAJE, BOMBA DE AGUA		TUBO DRENAGGIO ACQUA		TUBE DE VIDANGE DE LA POMPE À EAU	
REF	OEM			1	2		
1	REC17453-93901	17453-93900/01	DT15C DT9.9, DT15 K1-K4 DT9.9K, DT15K G-Y DF15 DF9.9, DF15T-K3 DF9.9, DF15(R)	(1989-97) (2001-04) (1986-00) (2012) (1996-03) (2004-11)			
2	REC17431-92L20	17431-92L20 17431-94440/1	DT40C-W G-X DT40W K1-K4	(1986-99) (2001-04)			
3	REC17560-91L00	17560-91L00 17560-96300/1/4	DT20, DT25, DT30G-Y DT25, DT30 K1-K2	(1986-00) (2001-02)			

BUSHING		BUJE EJE TRANSMISION		GUARNIZIONE		DOUILLE	
REF	OEM						
REC57130-94301	57130-94301	DF40, DF50 DF40A, DF50A, DF60A DT25C, DT30C DT40 DT40W DT55, DT65	X-K10 K-Y C-W G-X K1-K4 J-X	(1999-10) (2010+) (1989-00) (1986-99) (2001-04) (1988-99)			<b>NEW</b>

SCREW		TORNILLO		VITE		VIS	
REF	OEM			1	2		
1	REC09116-06094	09116-06094	M6 x 15				
2	REC09116-06121	09116-06121	M6 x 25				
3	REC09116-08128	09117-08056 09117-08128	M8 x 40				
4	REC09116-08131	09116-08131	M8 x 45	<b>NEW</b>	<b>NEW</b>		

5

DIAVOLO		DIÁBOLO		DIAVOLO		DIABOLO	
DIAVOLO ASSY		DIÁBOLO COMPLETO		DIAVOLO COMPLETO		DIABOLO COMPLET	
REF	OEM						
1	REC56120-93900	56120-93900/1-0EP 56120-93900-002M 56120-90L00/1/2-0EP	DF9.9, DF15T-K3 DF9.9, DF15(R) DT9.9, DT15K1-K4 DT15	(1996-03) (2004-12) (1986-04) (1989-97)			
2	REC56120-96332-0EP	56120-96332-0EP	DF20R, DF25, DF25RVZ DF25, DF30Y-K6 DT25, DT30K1-K2	(2006-11) (2000-06) (2001-02)			
3	REC56120-94321-0EP	56120-94321-0EP	DF40, DF50X-K10 DF40A, DF50A, DF60A DT40W-K1-K4	(1999-10) (2010-16) (2001-04)			
4	REC56120-87L30-0EP	56120-87L00/10/30-0EP	DF70A, DF80A, DF90A	(2009-16)			
5	REC56120-92J01-0EP	56120-92J00/1-0EP	DF100A, DF115A, DF140A DF115WT, DF140WT DF140	(2013-16) (2003) (2002-12)			
6	REC56120-93J50-0EP	56120-93J50-0EP 56120-93J70-0EP 56120-93J00/1/2/3-0EP	DF200, DF225, DF250 DF150T/Z, DF175T/Z/G	(2004-16) (2006-15)			



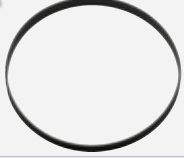

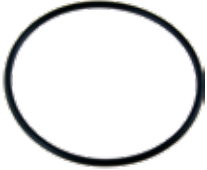
BUSHING		CASQUILLO CIERRE DIABOLO		GHIERA	MANCHON
REF	OEM				
REC56129-93L00	56129-93L00	DF250AP, DF300AP DF250AP/ATSS, DF300AP	(2012-23) (2024-25)		

DIAVOLO, O-RING		ARO TÓRICO DEL DIÁBOLO		O-RING DIAVOLO	JOINT TORIQUE DU DIABOLO
REF	OEM				
1 REC09280-57002	09280-57002	DF15 DF8A, DF9.9A (AR) DF9.9, DF15T-K3 DF9.9, DF15(R) DF9.9B, DF15A, DF20A DT15C DT9.9, DT15 DT9.9K, DT15K-G DF40, DF50X-K10 DT40C-W DT40W	(2012) (2010+) (1996-03) (2004-11) (2013+) (1989-97) (2001-04) (1986-00) (1999-10) (2010+) (1986-99) (2001-04)	3.5 x 65.2 mm	
2 REC09280-75001	09280-75001	DF40A, DF50A, DF60A DT40C-W DT40W	K1-K4 G-X K1-K4	3.3 x 75 mm	
3 REC09282-25001	09282-25001	DF70A, DF75A, DF80A, DF90A, DF100B	(2009+)	25 x 38x 8 mm	
4 REC09280-00050	09280-00030	DF250AP, DF300AP	(2014+)	117.6 x 1.8 mm	
5 REC09280-92004	09280-92004	DF70A, DF75A, DF80A, DF90A, DF100B	(2009+)	89.4 x 3.1 mm	



6

CLUTCH DOGS		SELECTOR		SELETTORE	CRABOT
REF	OEM				
1 REC57621-94403	57621-94400/3 57621-87100/1/2/3	DT40C-W G-X DT40W K1-K4 DF40, DF50X-K10 DF40A, DF50A, DF60A DT20, DT25, DT30G-Y	(1986-99) (2001-04) (1999-10) (2010+) (1986-00)		
2 REC57621-91L10	57621-91L10 57621-96300/10	DT25, DT30K1-K2 DT25C, DT30C K-Y DF25A, DF30A	(2001-02) (1989-00) (2015)		
3 REC57621-92J20	57621-92J10/20	DF90, DF100, DF115 DF100A, DF115A, DF140A DF140	(2001-11) (2013-21) (2002-12)		

CLUTCH PIN		PASADOR PARA SELECTOR		PIN SELETTORE	PIVOT
REF	OEM				
1 REC57634-88L00	57634-88L00	DF40, DF50X-K10 DF40A, DF50A, DF60A DF20R, DF25, DF25RVZ DF25, DF30Y-K6 DF25A, DF30A	(1999-10) (2010+) (2006-13) (2000-06) (2015+)		
2 REC09209-08016	09209-08016	DT20, DT25, DT30G-Y DT25, DT30 DT25C, DT30C	K1-K2 K-Y (1986-00) (2001-02) (1989-00)		

SPRING CLUTCH		MUELLE PARA SELECTOR		MOLLA SELETTORE		RESSORT DE SELECTEUR	
REF	OEM						
1	REC09440-32008	09440-32008	DF9.9, DF15TK3 DF9.9, DF15(R) DF15 DT15C DT9.9, DT15 DT9.9K, DT15K	K1-K4 G-Y	(1996-03) (2004-11) (2012) (1989-97) (2001-04) (1986-00)		1
2	REC09440-40002	09440-40002	DF40, DF50X-K10 DF40A, DF50A, DF60A DT40C-W DT40W DT55, DT60J-X	G-X K1-K4	(1999-10) (2010+) (1986-99) (2001-04) (1988-99)	REC57621-94403	2
3	REC09440-08043	09440-08043	DF40, DF50X-K10 DF40A, DF50A, DF60A		(1999-10) (2010+)		3
4	REC09440-05027	09440-05027	DF9.9, DF15T-K3 DF9.9, DF15(R) DT15C DT8, DT9.9C DT9.9, DT15 DT9.9, DT15K	J-V K1-K4 G-Y	(1996-03) (2004-11) (1989-97) (1988-97) (2001-04) (1986-00)		4



ARM, CLUTCH		EXTREMO PARA SELECTOR		HEBEL		EMBOUT DE SELECTEUR	
REF	OEM						
REC23211-94401	23211-94401	DT25C, DT30C-K-Y DT40C-W G-X DT40W-K1K4	(1989-00) (1986-99) (2001-04)				



PIN		PIN		SPINOTTO		PIN	
REF	OEM						
1	REC57632-97L00	57632-97L00 57632-98500/1	DF15 DF4, DF5, DF6 DF8A, DF9.9A (AR) DF9.9, DF15T-K3 DF9.9, DF15(R) DT15C DT4-J4, DT5Y DT5, DT6, DT8G-Y DF9.9B, DF15A, DF20A	(2012) (2002-15) (2010+) (1996-03) (2004-11) (1989-97) (1988-00) (1986-00) (2013+)			
	REC57632-93L01	57632-93L01	DF150 - DF130				
	REC57632-93L11	57632-93L11	DF150 - DF130				
	REC57632-94J00	57632-94J00	DF8 - DF20A				
	REC09202-05022	09202-05022	DF40, DF50X-K10 DF40A, DF50A, DF60A DT40C-W G-X DT40W K1-K4	(1999-10) (2010+) (1986-99) (2001-04)			
2	REC09202-04002	09202-04002	DF2.5 - DF6 DT2 - DT5				
	REC09202-05021	09202-05021	DF20R, DF25, DF25R V2 DF25, DF30 Y-K6 DF25A, DF30A DT20, DT25, DT30 G-Y K1-K2-KY	(2006-13) (2000-06) (2015+) (1986-02)			

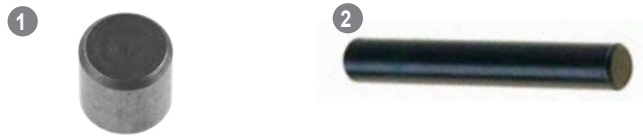

ROD PUSH		VARILLA PARA SELECTOR		ASTA PRESSIONE		TIGE DE POUSSEE	
REF	OEM						
1	REC57631-93901	57631-93901	DF15 DF8A/AR, DF9.9A DF9.9, DF15(R) DF9.9B, DF15A, DF20A DT15C DT9.9, DT15 K1-K4 DT9.9K, DT15K G-Y	(2012) (2010+) (2004-11) (2013+) (1989-97) (2001-04) (1986-00)			
2	REC57631-96301	57631-96301	DF25, DF30Y-K6 DT20, DT25, DT30G-Y DT25, D30 K1-K2 DT25C, DT30C K-Y	(2000-06) (1986-00) (2001-02) (1989-00)			
3	REC57631-95303	57631-94700 57631-95301/2/3	DF40, DF50X-K10 DF40A, DF50A, DF60A DT40C-W G-X DT40W K1-K4 DT55, DT65J-X	(1999-10) (2010+) (1986-99) (2001-04) (1988-99)			

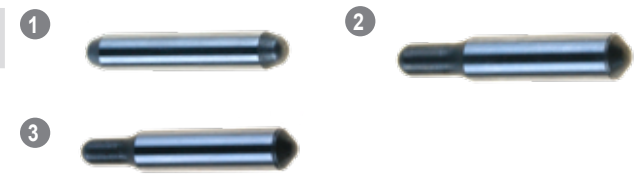

GASKET		JUNTA TAPA SELECTOR		GUARNIZIONE		JOINT	
REF	OEM						
1 REC55122-93L00	55122-93L00	DF250AP, DF300AP DF250AP/ATSS, DF300AP DF300T/Z	(2013-22) (2024-25) (2007-11)				
2 REC09280-40019	09280-40016/19	DF200, DF225, DF250 DF250AP, DF300AP DF250AP/ATSS, DF300AP DF350A, DF325A, DF300B	(2020+) (2020-23) (2024-25) (2020-25)		39.7X3.5		
3 REC55122-98L00	55122-98L00						

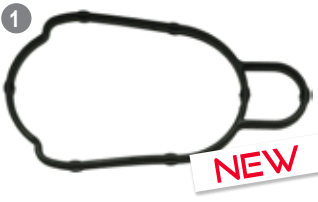

1

**NEW**



2

**NEW**



3

**NEW**

7

BEARING	RODAMIENTOS	CUSCINETTO	ROULEMENT
WATER PUMP	BOMBA DE AGUA	POMPA ACQUA	ROULEMENT DE POMPE À EAU

REF	OEM		
1 REC09263-25062	09263-25062	DF40, DF40X-K10 DT40C-W G-X DT40W K1-K4	(1999-10) (1986-99) (2001-04)
2 REC09263-25025	09263-25025/48 09263-25L02		



1



2

REF	OEM		
1 REC08110-60020	08110-60020	DF8 --> DF20 DT9.9, DT15 DF150, DF300 DT20R, DF25, DF25V2 DF25, DF30Y-K6 DF25A, DF30A DT20, DT25, DF30G-Y DT25, DT30 K1-K2 DT25C, DT30C K-Y	(OIL PUMP) (2006-13) (2000-06) (2015+) (1986-00) (2001-02) (1989-00)
2 REC09265-17002	09265-17002		



1



2

REF	OEM		
1 REC09263-15019	09263-15019	DF15 DF9.9, DF15T-K3 DF9.9, DF15(R) DT15C DT5, DT6, DT DT6, DT8 DT9.9, DT15 DT9.9K, DT15K DF20R, DF25, RVZ DF25 (R) QVZ DF255, DF30Y DF25A, DF30A DT20, DT25, DT30G-Y DT25, DT30 DT25C, DT30K-Y DF40A, DF50A, DF60A DF40, DF50X-K10 DT40C-W DT40W	01503F (2012) (1996-03) (2004-11) (1989-1997) G-Y (1986-00) Y-K2 (2000-02) K1-K4 (2001-04) G-Y (1986-00) (2006-13) K-6 (200-06) (2015+) (1986-00) K1-K2 (2001-02) (1989-00) (2010-19) (1999-10) (1986-99) G-X (2001-04) K1-K4 (2001-04)
2 REC09263-20046	09263-20046		
3 REC09263-22L03	09263-22L03 09263-22039		
4 REC09269-32002	09269-32001/2	DF150AP, DF175AP, DF200AP DF150AP, DF175AP, DF200AP DF150T/G/Z, DF175T/G/Z DF200, DF225, DF250 DF200A/AP DF200AT/AZ DF300T/Z DF150AT, DF175A, DF200AT DF250AP, DF300AP	(2018) (2017+) (2006-18) (2004+) (2015-17) (2018-21) (2007-11) (2019+) (2013+)



1



2



3



4

**NEW**

DIABOLO

DIÁBOLO

DIABOLO

DE DIABOLO

REF	OEM		
1 REC08110-60050	08110-60050	DF8A, DF9A DF9.9, DF15 DF9.9B, DF15A, DF20A DT9.9, DT15 DF25A, DF30A DF25, DF30Y-K6 DF25, DF25R, DF25QVZ	(2012+) (1996-12) (2015+) (1986-04) (2015+) (2000-06) (2013)
2 REC09263-20047	09263-20047	DF20R, DF25, DF25RVZ DT20, DT25, DT30G-Y DT25, DT30 DT25C, DT30C DF25A, DF30A DF20R, DF25RVZ DF25, DF30Y-K6 DT20, DT25, DT30 DF40A, DF50A, DF60A DF40, DF50X-K10 DT40C-W DT40W DT55, DT65	(2006-11) (1986-00) (2001-02) (1989-00) (2015+) (2006-11) (2000-06) (1986-02) (2010+) (1999-10) (1986-99) (2001-04) (1988-99)
3 REC08113-60060	08113-60060		
4 REC09263-22020	09263-22020		



BEARING

RODAMIENTO

CUSCINETTO

ROULEMENT

REF	OEM			
1 REC09263-20L04	09263-20L04 09263-20024	DF8A/AR, DF9.9A/AR DF9.9B, DF15A, DF20A DT55, DT65	(2013-16) (2013-16) (1988-99)	
2 REC09263-26023	09263-26023 09263-26008	DF60, DF70 DT90, DT100 DF70A, DF75A, DF80A, DF90A, DF100B DF70A, DF75A, DF80A, DF90A, DF100B DF300T/Z	J-X WK-9 L-Y (1998-09) (1990-00) (2012+) (2009+) (2007-11)	26X34X30
3 REC09263-25067	09263-25067	DF150AT, DF175AT, DF200AT DF150T/Z, DF175T/Z DF200, DF225, DF250	(2019+) (2017+) (2020+)	25X32X26

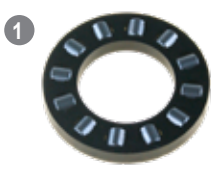

8

GEARS

PIÑONES

PIGNONE

PIGNONES

INITIATIVE GEAR

PIÑÓN DE ATAQUE

PIGNONE ATTACCO

PIGNON D'ATTAQUE

REF	OEM		
1 REC57311-98400	57311-98400	DT2, DT2.2	(1986+)
2 REC57311-98600	57311-98600/1	DF4, DF5, DF6 DT4-J4, DT5Y DT4 K1 DT5Y	(2002-11) (1988-00) (2001) (1998-02)
3 REC57311-93910	57311-93910 57311-90L00	DT9.9, DT15 DF9.9, DF15	(2001-04) (1996-04)
4 REC57311-99J10	57311-99J10	DF8A, DF9.9A (AR) DF9.9B, DF15A, DF20A	(2012+) (2013+)
5 REC57311-96311	57311-96310/11/20 57311-91L00	DT20, DT25, DT30 DF20, DF25 (RVZ) DF20R, DF25, DF25R V2 DF25, DF30 DT25, DT30 DF25A, DF30A	(1986-06) (2006-13) (2006-13) (2000-06) (2001-02) (2015+)
6 REC57311-96320	573311-96320		
7 REC57311-94402	57311-94401/2	DT40	(1986-04)
8 REC57311-93901	57311-93901	DT415C	(1989-97)

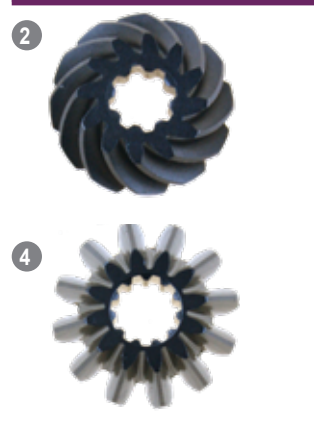

POSITIVE GEAR		PIÑÓN MARCHA AVANTE	
REF	OEM		
1 REC57510-91J00	57510-91J00 57510-98600 57510-98610/11	DT4/J4, DT5Y DT4 K1 DT5Y	(1988-00) (2001) (1998-02)
2 REC57510-99J11	57510-99J11	DF4, DF5, DF6 DF8, DF9.9A/AR DF9.9B, DF15A, DF20A	(2002+) (2012+) (2013+)
3 REC57510-93910	57510-93910 57510-90L00	DT9.9, DT15 DF9.9, DF15	(2001-04) (1996-11)
4 REC57510-93902	57510-93902	DT15C	(1989-97)
5 REC57510-94402	57510-94400/1/2	DT40	(1986-04)
6 REC57510-89J00	57510-89J00 57510-91L00	DT25, DT30 DF25, DF30 DF20R, DF25 (R) (VZ)	(2001-02) (2000-06) (2006-13)



PIGNONE MARCIA AVANTI	
1	

PIGNON DE MARCHE AVANT	
2	 <b>NEW</b>



REVERSE GEAR		PIÑÓN MARCHA ATRÁS	
REF	OEM		
1 REC57521-91J00	57521-91J00	DF4, DF5, DF6 DT4/J4, DT5Y DT4K1	(2002-15) (1988-00) (2001)
2 REC57521-99J10	57521-99J10	DT5Y DF8A/AR, DF9.9A/AR DF9.9B, DF15A, DF20A	(1998-02) (2012+) (2014+)
3 REC57521-93910	57521-93910 57521-90L00	DF9.9, DF15 DT9.9, DT15	(1996-11) (2001-04)
4 REC57521-93902	57521-93902 57310-93850	DT15C	(1989-97)
5 REC57521-96312	57521-96311/12	DT20, DT25, DT30	(1986-02)
6 REC57521-89J00	57521-89J00	DF25, DF30 DF20R, DF25 (R,Q) (VZ)	(2000-06) (2006-13)
7 REC57521-94400	57521-94400/1	DT40	(1986-04)



PIGNONE MARCIA INDIETRO	
1	
3	
7	

PIGNON DE MARCHE ARRIERE	
2	 <b>NEW</b>
4	

GEAR KIT		KIT DE PIÑONES	
REF	OEM		
1 REC57300-93860	57300-93860	DF200, DF225, DF250	(2014+)
2 REC57300-96810	57300-96810	DF150T(G)/Z, DF175T(G)/Z	(2006-18)
3 REC57300-96850	57300-96850	DF150/175/200AT/AZ DF150A, DF175A, DF200A DF150AT, DF175AT, DF200AT DF200A DF200AT/AZ	(2020-21) (2024-25) (2019-23) (2015-17) (2018)

KIT DE PIGNONE	
1	
2	
3	

KIT DE PIGNONES	
1	 <b>NEW</b>
2	 <b>NEW</b>
3	 <b>NEW</b>

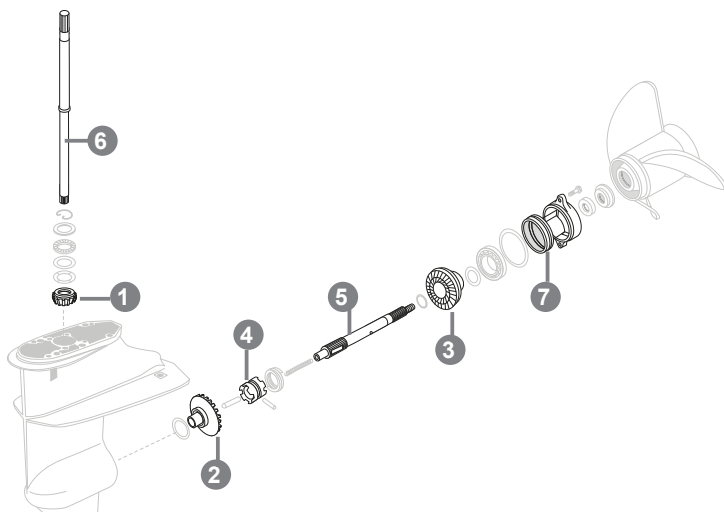

GEAR APPLICATION		GUÍA DE PIÑONES		GUIDA DI PIGNONE		GUIDE DES PIGNONS			
		1	2	3	4	5	6 L	6 S	7
DT2	1986-00	REC57311-98400							
DT2.2 K1-K5	2001-05	REC57311-98400							
DT9.9K, DT15K-G-Y	1986-00	REC57311-93901	REC57510-93902	REC57521-93902		REC57610-93901	REC57100-93902		REC56120-93900
DT9.9, DT15K1-K4	2001-04	REC57311-93910	REC57510-93910	REC57521-93910		REC57610-93901	REC57100-93902		REC56120-93900
DF9.9, DF15T-K3	1996-03	REC57311-93910	REC57510-93910	REC57521-93910		REC57610-93901	REC57100-93902		REC56120-93900
DF9.9, DF15R	2004-11	REC57311-93910	REC57510-93910	REC57521-93910		REC57610-93901	REC57100-93902		REC56120-93900
DT15C	1989-97	REC57311-93901	REC57510-93902	REC57521-93902		REC57610-93901			REC56120-93900
DF15	2012					REC57610-93901	REC57100-93902		
DT20, DT25, DT30G-Y	1986-00	REC57311-96311	REC57510-89J00	REC57521-96312					
DT25C, DT30C-K-Y	1989-00	REC57311-96311	REC57510-89J00	REC57521-96312					
DT25, DT30K1-K2	2001-02	REC57311-96320	REC57510-89J00	REC57521-89J00					
DF25, DF30Y-K6	2000-06	REC57311-96320	REC57510-89J00	REC57521-89J00					
DT40C-W G-X	1986-99	REC57311-94402	REC57510-94402	REC57521-94400			REC57110-94441	REC57110-94411	
DT40W K1-K4	2001-04	REC57311-94402	REC57510-94402	REC57521-94400			REC57110-94441	REC57110-94411	
DF40, DF50X-K10	1999-10								REC57621-94403

WASHER / SHIM		ARANDELA / GRUESOS		RONDELLA / SPESSORE		RONDELLE / CALE		
REF	OEM							
1	REC09160-21009	09160-21009	DF8A, DF8AR, DF9.9A, DF9.9AR DF9.9, DF15T-K3 DF15 DF9.9, DF15(R) DF9.9B, DF15A, DF20A DT9.9K, DT15G-Y DT15C DT9.9, DT15K1-K4	X-K10	(2010+) (1996-03) (2012) (2004-11) (2013) (1986-00) (1989-97) (2001-04)	21 x 35 x 2.75 mm		
	REC09160-20042	09160-20042	DF8A, DF8AR, DF9.9A, DF9.9AR DF9.9, DF15T-K3 DF15		(2010+) (1996-03) (2012)	T: 1.1		
2	REC09160-20043	09160-20043	DF9.9, DF15(R) DF9.9B, DF15A, DF20A DT9.9K, DT15G-Y DT15C DT9.9, DT15K1-K4		(2004-11) (2013) (1986-00) (1989-97) (2001-04)	T: 1.2		
	REC09160-20044	09160-20044	DF9.9 DT15, DF15 DF20		(1986-00) (1989-97) (2001-04)	T: 0.7		
3	REC09160-20027	09160-20027	DF8A/AR, DF9.9A/AR DF9.9B, DF15A, DF20A		(2011-15) (2010+) (2013+)	21 x 35 x 2.75 mm		
4	REC09160-20041	09160-20041	DT9.9 DT15		(1983-87) (1983-97)	T: 1.0		
5	REC08211-20263	08211-20263	DF40/DF50 DF40A/DF50A/DF60A DT40 DT40 DT55/DT65 DF40, DF50X-K10 DT40C-W G-X DT40W K1-K4	C-W G-X W K1-K4 J-X	(1999-10) (2010+) (1986-99) (2001-04) (1988-99) (1999-10) (1986-99) (2001-04)	T: 2.0		
6	REC09160-26015	09160-26015			(1999-10) (1986-99)	26.2 x 42 x 4.0 mm		
7	REC09160-06085	09160-06085				6.5 x 15 x 1.0 mm		
8	REC09160-12066	09160-12066				12.5 x 22 x 2.5 mm		
9	REC09160-18028	09160-18028	DF40 - DF300 DT40 - V6 H-Y			18.5 x 31 x 1 mm		
10	REC09160-20041	09160-20041				T: 1.0		
11	REC09160-20052	09160-20052						
12	REC09160-27008	09160-27008				27 x 36 x 1 mm		

# Propulsion System

PROPULSION SYSTEM

SISTEMA DE  
PROPULSIÓNSISTEMA DI  
PROPULSIONESYSTÈME DE  
PROPULSION

1

PROPELLER  
COMPONENTS

## COMPONENTES HÉLICE

COMPONENTI  
DELL'ELICACOMPOSANTS DE  
L'HELICE

PROPELLER NUT KIT		KIT CIERRE DE HÉLICE		KIT CHIUSURA ELICA		KIT ECROU D'HELICE	
REF	OEM						
1	REC57630-96300	57630-96300	DF20R, DF25, DF25R V2 DF25, DF30Y-K6 DT20, DT25, DT30G-Y DT25, DT30K1-K2 DT25C, DT30C-K-Y	(2006-11) (2000-06) (1986-00) (2001-02) (1989-00)	SUZUKI P. 99		
2	REC57630-94500	57630-94550	DF40A, DF50A, DF60A DF60, DF70W-K9 DT75, DT85J-Y DT90, DT100L-Y DT115, DT140G-Y DF60, DF70 V-STYLE	(2014) (1998-09) (1988-00) (1990-00) (1986-00)	SUZUKI P. 104		
3	REC57630-94300	57630-94300/1	DF40, DF50X-K10 DF40A, DF50A, DF60A DT40C-W G-X DT40W K1-K4 DT55, DT65J-X	(1999-10) (2010+) (1986-99) (2001-04) (1988-99)	SUZUKI P. 101 SUZUKI P. 103		
4	REC57630-92E00	57630-92E00	DF150, DF175Z-T(G) DF200, DF225, DF250 DF200A DF300A-T-Z DF150, DT200, DT225W-K3 V6 H-Y	(2006-14) (2004+) (20015+) (2007-12) (1998-03) (1987-00)	SUZUKI P. 111 SUZUKI P. 113		
5	REC57630-90J00	57630-90J00	DF100A, DF115A, DF140A DF100C DF140 DF115B DF140B DF40A, DF50A, DF60A DF70A, DF80A, DF90A, DF100B DF90, DF100, DF115	(2013-21) (2023) (2002-12) (2021-23) (2021-23) (2014+) (2009+) (2001-12)	SUZUKI P. 91 SUZUKI P. 109		



PROP SHAFT		EJE DE HELICE		ASSE ELICA	ARBRE D'HELICE
OEM		A			
REC57610-92J20	57610-92J20	15	DF100A, DF115A, DF140A (2013-21) DF100C (2023+) DF115BG/BZG (2022) DF140 (2002-12) DF140B, DF115B (2022+)		
REC57610-93901	57610-93901		DT9.9 - DT15 DF9.9 - DF15		
REC57610-94402	57610-94402		DF40 - DF50, DF40A - DF50A, DF60A		
REC57610-96311	57610-96311		DF20, DF25, DF30, DF25A - DF30A DT25 - DT30		

NEW

COTTER PIN		PASADOR DE LA TUERCA DE HÉLICE		COPPIGLIA	GOUPILLE D'ECROU D'HELICE
REF	OEM			1	2
1	REC91490-30025	09204-03003	2.5 --> 350 HP		
2	PAGB/T91-1.6X12	09204-02001	DF2.5 DT2, DT2.2HP PLASTIC PROPELLER HELICE DE PLASTICO ELICA IN PLASTICA HELICE DE PLASTIQUE	3	
3	REC09204-02004	09204-02004	8 --> 20HP		

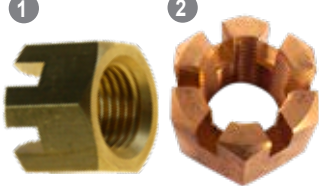
PROPELLER NUT		TUERCA DE HÉLICE		DADO DI ELICA	ÉCROU D'HÉLICE	
REF	OEM					
1	REC09141-12005	09141-12005	DF8A, DF9.9A (AR) DF9.9, DF15T-K3 DF9.9, DF15(R) DF9.9B, DF15A, DF20A DT15C DT9.9, DT15K1-K4 DT9.9K, DT15K G-Y			(2010+) (1996-03) (2004-11) (2013+) (1989-97) (2001-04) (1986-00)
2	REC90171-18M04	09141-18005	DT/DF40 --> DT/DF300 HP			

PROPELLER PIN		PASADOR DE HÉLICE		PIN ELICA	CLAVETTE D'HELICE
REF	OEM				
REC09202-04002	09202-04002	DF2.5 DF4, DF5, DF6 DT2, DT2.2 G-Y DT4/J4 DT5Y	(2006-13) (2002-11) (1986-00) (1988-00) (1988-02)		

SEPARADOR DE HÉLICE		PROPELLER WASHER		DISTANZIALE ELICA	ENTRETOISE D'HELICE	
REF	OEM					
1	REC57632-94J00	57632-94J00	DF8A, DF9.9A (AR) DF9.9, DF15(R) DF9.9B, DF15A, DF20A BACK   TRASERO   POSTERIORE   ARRIERE			(2010+) (2004-11) (2013+)
2	REC57633-93901	57633-93900/1	DF8A, DF9.9A (AR) DF9.9, DF15(R) DF9.9B, DF15A, DF20A FRONT   DELANTERO   ANTERIORE   AVANT			(2010+) (2004-11) (2013+)
3	REC57633-90J02	57633-90J00/1/2	DF100A, DF115A, DF140A DF100C DF115BG/BZG DF140 DF140B DF40A, DF50A, DF60A DF70A, DF80A, DF90A, DF100B DF90, DF100, DF115			(2013-21) (2023) (2021-22) (2002-12) (2021+) (2014+) (2009+)
4	REC57632-93L11	57632-93L10/11 57632-93LV0	DF150AP, DF175AP, DF200AP DF150AT, DF175AT, DF200AT DF200, DF225, DF250 DF250AP, DF300AP			(2019+) (2019+) (2019+) (2019+)
5	REC57632-93L01	57632-93L00/1	DF200, DF225, DF250 DF150, DF175 G/T/Z DF150AP, DF175AP, DF200AP DF200A, DF200AP, DF300AP	(2012-18) (2012-18) (2017-18) (2012-18)		

NEW

NEW

NEW

PROPELLER NUT, WASHER

ARANDELA DE TUERCA DE HÉLICE

RONDELLA DI DADO DI ELICA

RONDELLE D'ÉCROU D'HÉLICE

REF	OEM			
REC09160-18028	09160-18028	DF40 - DF300 DT40 - V6 H-Y	18.5 x 31 x 1 mm	<b>NEW</b>

2

ALUMINIUM & SS PROPELLERS

HÉLICES ALUMINIO E INOXIDABLE

ELICHE ALLUMINIO E INOX

HELICE ALUMINIUM ET INOX

SOLAS PROPELLERS	HÉLICES SOLAS	ELICHE SOLAS	HÉLICE SOLAS
<p><b>AMITA 3</b></p> <p>3, 4 Blade aluminum propeller with heavy duty rubber hub. Smoother low speed makes the offshore boating activity much easier.</p>	<p>Hélices de aluminio de 3, 4 palas con núcleo de goma de gran resistencia. Suaves a poca velocidad y hace el barco muy manejable con la mar picada.</p>	<p>Eliche di alluminio a 3, 4 pale con mozzo in gomma ad alta resistenza. Molto morbido a bassa velocità e rende la barca molto maneggevole con mare cattivo.</p>	<p>Hélice en aluminium 3, 4 pales avec moyeu en caoutchouc, Permet d'aller doucement à basse vitesse et rende le bateau très maniable lorsque la mer est agitée</p>
<p><b>AMITA 4</b></p> <p>Three blade stainless steel propeller. Large diameter and blade area for big boat loads. Great high speed performance without sacrificing mid-range speeds. Excellent fuel economy.</p>	<p>Hélices de acero inoxidable de 3 palas. Gran diámetro del área de las palas para barcos pesados. Gran rendimiento en alta velocidad sin sacrificar las velocidades medias. Excelente ahorro de combustible.</p>	<p>Eliche di acciaio inox a 3 pale. Grande diametro delle pale per imbarcazioni pesanti. Grandi prestazioni ad alta velocità senza sacrificare velocità medie. Eccellente risparmio di carburante.</p>	<p>Hélice inox 3 Pales, grand diamètre pour bateaux lourds. Excellentes performances à grande vitesse sans sacrifier les vitesses moyennes. Excellente économie de carburant.</p>
<p><b>NEW SATURN</b></p> <p>Three blade stainless steel propeller. Offers good acceleration &amp; all-round performance. Smaller pitch sizes offered in extra large diameter with increased blade area.</p>	<p>Hélices de acero inoxidable de 3 palas. Ofrece buena aceleración y rendimiento. Tamaño más pequeño que ofrece un diámetro extra-grande.</p>	<p>Eliche di acciaio inox a 3 pale. Buona accelerazione. Piccole dimensioni che offre un più grande diametro.</p>	<p>Hélice inox 3 pales, offrant de bonnes accélérations et performances. Taille de pas réduite pour les modèles de grands diamètres avec une surface de pale plus importante.</p>
<p><b>HR TITAN 3 PROP</b></p> <p>Stainless steel propeller. Performance prop for high speed planing hulls. High rake blade design provides excellent bow lift and acceleration. Heavy cup design increases bite and reduces slip</p>	<p>Hélice de acero inoxidable. Alto rendimiento para cascos de alta velocidad. La inclinación de la hoja proporciona un excelente elevación de proa y aceleración. El diseño de copa grande aumenta la mordida y reduce el deslizamiento.</p>	<p>Eliche in acciaio inox. Alte prestazioni per scafi ad alta velocità. Il passo della pala fornisce un'eccellente spinta e accelerazione. Il disegno aumenta le prestazioni.</p>	<p>Hélice en acier inoxydable. Hélice de performance pour les coques de planification à grande vitesse. La conception de la lame à haut râteau offre une excellente portance et accélération de l'arc. La conception lourde de la tasse augmente la morsure et réduit le glissement.</p>



AMITA 3



AMITA 4



LEXOR



NEW SATURN



HR TITAN 3 PROP





PROPELLERS FOR  
INTERCHANGEABLE HUBHÉLICES PARA NÚCLEO  
INTERCAMBIABLEELICHE PER MOZZO  
INTERCAMBIABILEHELICES AVEC MOYEU  
INTERCHANGEABLE

	B	D	P	R	AL
C 30-75 HP	3	12.1	9	R	SOL9311-121-09
		12	10	R	SOL9311-120-10
		11-6	11	R	SOL9311-116-11
		11.4	12	R	SOL9311-114-12
		11.1	13	R	SOL9311-111-13
		11.1	14	R	SOL9311-111-14
D 40-140 HP	3	11	15	R	SOL9311-110-15
		14	9	R	SOL9411-140-09
		14	11	R	SOL9411-140-11
		13.8	17	R	SOL9411-139-17
		13.8	19	R	SOL9411-139-19
		13.8	21	R	SOL9411-139-21
		13.75	13	R	SOL9411-138-13
		13.50	15	R	SOL9411-135-15
		13.25	17	R	SOL9411-133-17
		13.2	19	R	SOL9411-132-19
E 135-350 HP	3	13.2	21	R	SOL9411-132-21
		15.5	11	R	SOL9511-155-11
		15.3	13	R	SOL9511-153-13
		16	13	R	SOL9511-160-13
		15	15	R	SOL9511-150-15
		15	15	L	SOL9511-150-15
		14.8	17	R	SOL9511-148-17
		14.8	17	L	SOL9511-148-17
		14.5	19	R	SOL9511-145-19
		14.5	19	L	SOL9511-145-19
14.3	21	R	SOL9511-143-21		
14.3	21	L	SOL9511-143-21		

	B	D	P	R	STAINLESS STEEL INOX
C 30-75 HP	3	11 <sup>5/8</sup>	11	R	SOL9331-116-11
		11 <sup>3/8</sup>	12	R	SOL9331-114-12
		11 <sup>1/8</sup>	13	R	SOL9331-111-13
		11 <sup>1/8</sup>	14	R	SOL9331-111-14
		11	15	R	SOL9331-110-15
		13 <sup>3/4</sup>	13	R	SOL9431-138-13
D 40-140 HP	3	13 <sup>1/2</sup>	15	R	SOL9431-135-15
		13 <sup>1/4</sup>	17	R	SOL9431-133-17
		13 <sup>1/4</sup>	17	L	SOL9432-133-17
		13	19	R	SOL9431-130-19
		13	19	L	SOL9432-130-19
		13	21	R	SOL9431-130-21
		14 <sup>1/2</sup>	15	R	SOL9531-145-15
		14 <sup>1/2</sup>	15	L	SOL9532-145-15
		14 <sup>1/4</sup>	17	R	SOL9531-143-17
		14 <sup>1/4</sup>	17	L	SOL9532-143-17
E 90-140 HP	3	14	19	R	SOL9531-140-19
		14	19	L	SOL9532-140-19
		14	21	R	SOL9531-140-21
		14	21	L	SOL9532-140-21
		14	23	R	SOL9531-140-23
		14	23	L	SOL9532-140-23

Interchangeable hub (not included).  
Núcleo intercambiable (no incluido).  
Mozzo intercambiabile (non incluso).  
Moyaux interchangeable (non inclus)

RUBEX

 SOLAS

	B	D	P	R	STAINLESS STEEL INOX
E 135-350 HP	3	15 <sup>3/4</sup>	15	R	SOL9571-158-15
		15 <sup>3/4</sup>	15	L	SOL9572-158-15
		15 <sup>1/2</sup>	17	R	SOL9571-155-17
		15 <sup>1/2</sup>	17	L	SOL9572-155-17
		15 <sup>1/4</sup>	19	R	SOL9571-153-19
		15 <sup>1/4</sup>	19	L	SOL9572-153-19
		15	21	R	SOL9571-150-21
		15	21	L	SOL9572-150-21
		14 <sup>3/4</sup>	23	R	SOL9571-148-23
		14 <sup>3/4</sup>	23	L	SOL9572-148-23
14 <sup>1/2</sup>	25	L	SOL9572-145-25		

Interchangeable hub (not included).  
Núcleo intercambiable (no incluido).  
Mozzo intercambiabile (non incluso).  
Moyaux interchangeable (non inclus)

PROPELLERS WITH 4  
ALUMINIUM BLADES

## HÉLICES 4 PALAS ALUMINIO

## ELICHE 4 PALE ALLUMINIO

HELICES AVEC 4 PALES IN  
ALUMINIUM

	B	D	P	R	AL
D 40-140 HP	4	12.5	19	R	SOL9413-125-19
		12.8	17	R	SOL9413-128-17
		13	15	R	SOL9413-130-15
		13.3	13	R	SOL9413-133-13



RUBEX

REF --> OEM

AMITA 3	127	NGKBP6HS	22	PAGB/T5783-M6X16	115	REC08110-60020	91	REC09168-10034	105
AMITA 4	127	NGKBP6HS	22	09116-06094		08110-60020		09168-10034	
CHAQ178C	22	NGKBP6HS	23	09116-06225		REC08110-60020	93	REC09168-10034	111
CHAQ178C	23	09482-00299		PAGB/T5783-M6X16	89	08110-60020		09168-10034	
CHAQ182C	22	NGKBP6HS	23	09116-06225		REC08110-60020	95	REC09168-10034	112
CHAQ182YC	22	09482-00299		PAGB/T5783-M6X16	89	08110-60020		09168-10034	
CHAQ186C	22	NGKBP6HS	4	09116-06225		REC08110-60050	122	REC09168-10034	113
CHAQ187YC	22	NGKBP6HS	7	PAGB/T5783-M8X16	101	08110-60050		09168-10034	
CHARA8HC	23	NGKBP6HS	22	09117-08109		REC08110-60050	91	REC09168-10034	115
CHARC9YC	23	NGKBP6HS-10	22	PAGB/T5783-M8X16	103	08110-60050		09168-10034	
CHARN9YC	23	NGKBR4HS	22	09117-08109		REC08110-60050	93	REC09168-10034	117
CM11130-94600	51	NGKBR5HS	22	PAGB/T5783-M8X16	99	08110-60050		09168-10034	
11130-94600		NGKBR6HS-10	22	09117-08037		REC08110-60050	95	REC09168-10034	7
CM11130-94600A	51	NGKBR6HS	22	PAGB/T5783-M8X25	107	08110-60050		REC09168-10034	8
11130-94600		NGKBR7HS-10	22	09117-08057		REC08113-60060	122	REC09168-10034	9
CM41811-98500	50	NGKBR7HS	22	PAGB/T5783-M8X30	101	08113-60060		REC09168-10034BULK	117
41811-98500		NGKBR8HS-10	22	09117-08047		REC08113-60060	97	REC09168-12012	18
CM5033167	5	NGKBR8HS-10	23	PAGB/T5783-M8X30	91	08113-60060		09168-12012	
CM55125-87D00	51	NGKBR8HS-10	23	PAGB/T5783-M8X30	93	REC08113-60060	99	REC09168-12012	57
55125-87D00		NGKBR8HX	22	09117-08047		08113-60060		09168-12012	
55125-95500		NGKBR8HX	23	09117-08047		REC08113-60087	103	REC09168-12012	59
55125-87801		NGKBR8HS-10	22	PAGB/T5783-M8X30	95	08113-60087		09168-12012	
CM55125-87D00A	51	NGKBR8HS-10	23	09116-08151		REC08211-20263	105	REC09168-12012	6
55125-87D00		NGKBR8HS-10	22	PAGB/T5783-M8X55	93	08211-20263		REC09168-12012	61
55320-93900		NGKBR8HS	22	09116-08117		REC09116-06094	101	REC09168-12012	61
55125-87801		NGKBR8HS	23	PAGB/T5787-1986	89	09116-06094		REC09168-12012	62
CM55125-94502	51	NGKCP6GEA-9	23	09116-08156		REC09116-06094	111	REC09168-12012	62
55125-94502		NGKCP6GEA-9	23	PAGB/T5787-M6X20	115	09116-06094		REC09168-12012	63
CM55125-95301A	51	NGKCP6GEA-9	23	29116-93100		REC09116-06094	118	REC09168-12012	63
55125-95301		NGKCP6GEA-9	4	PAGB/T5787-M6X20	91	09116-06094		REC09168-12012	65
CM55125-95500	51	NGKCP6GEA-9	5	09116-06227		REC09116-06094	52	REC09168-12012	67
55125-87E01		NGKCP6GEA-9	54	PAGB/T5787-M6X20	93	09116-06094		REC09168-12012	67
CM55125-95500A	51	09482-00104		PAGB/T5787-M6X20	95	REC09116-06094	93	REC09168-12012	68
55125-87E01		NGKCP6GEA-9	55	09116-06227		09116-06094		09168-12012	
CM55125-96310	51	09482-00104		PAGB/T5787-M6X20	99	REC09116-06094	97	REC09168-12012	68
55125-96310		NGKCP6GEA-9	6	09116-06106		09116-06094		09168-12012	
CM55125-96310A	51	NGKCP6GEA-9	23	PAGB/T5787-M6X30	97	REC09116-06121	118	REC09168-12012	7
55125-96310		NGKCP6GEA-9	23	09116-08122		09116-06121		REC09168-12012	8
CM55300-95500	50	NGKCP6GEA-9	5	PAGB/T6184-2000	95	REC09116-06121	52	REC09168-12012	9
55300-95500		NGKCP6GEA-9	23	29141-93100		09116-06121		REC09168-12017	18
CM55300-95500A	50	NGKCP6GEA-9	23	PAGB/T6184-2000	99	REC09116-06121	91	REC09168-12017	4
55300-95500		NGKCP6GEA-9	4	09141-08020		09116-06121		09168-12017	
CM55320-95310	50	NGKDCPR6E	23	PAGB/T818-M4X30	104	REC09116-06121	97	REC09168-12017	5
55320-95310		NGKDCPR6E	23	09125-06063		09116-06121		REC09168-12017	54
55320-95310		NGKDCPR6E	23	PAGB/T818-M6X10	109	REC09116-06121	99	REC09168-12017	55
CM55320-95310A	50	09482-00446		PAGB/T818-M6X10	93	09117-08056	118	REC09168-12017	6
55320-98311		NGKDCPR6E	23	09125-06063		09117-08128		REC09202-04002	101
55320-95310		NGKDCPR6E	56	PAGB/T818-M6X14	52	REC09116-08131	109	REC09202-04002	120
CM55320-98400	50	09482-00446		09128-06221		09116-08131		09202-04002	
CM55320-98400A	50	NGKDCPR6E	58	PAGB/T820-M6X20	91	REC09116-08131	111	REC09202-04002	126
55320-98400		09482-00446		09126-06006		09116-08131		09202-04002	
CM55320-98600	51	NGKDCPR6E	59	PAGB/T820-M6X20	93	REC09116-08131	113	REC09202-05021	120
55320-98600		09482-00446		09126-06006		09116-08131		09202-05021	
CM55320-98600A	51	NGKDCPR6E	6	PAGB/T848-6	89	REC09116-08131	118	REC09202-05021	97
55320-98600		09482-00446		09160-06082		09160-06082		09202-05021	
CM55321-87J00	50	NGKDCPR6E	60	PAGB/T848-6	95	REC09140-14008	76	REC09202-05021	99
55321-87J00/1		09482-00446		09160-06082		09140-14008		09202-05021	
CM55321-87J00A	50	NGKDCPR6E	7	PAGB/T848-6	97	REC09141-12005	126	REC09202-05022	103
55321-87J00/1		NGKILZKR7D8	23	09160-06082		09141-12005		09202-05022	
CM55321-90J01	51	09482-00642		PAGB/T848-6	99	REC09141-12005	95	REC09202-05022	120
55321-90J01		NGKILZKR7D8	68	09162-06006		09141-12005		09202-05022	
CM55321-90J01A	51	09482-00642		PAGB/T879.1-2.5X14	4	REC09160-12066	95	REC09204-02004	126
55321-90J01A		NGKILZKR7D8	9	PAGB/T8.8-2000	107	REC09160-12066	109	REC09204-02004	5
CM55321-93900	51	NGKILKR6E	23	09125-05046		REC09160-18028	127	REC09204-02004	91
55321-93900		09482-00649		PAGB/T8.8-2000	109	REC09160-18028		09204-02004	
55320-93900		NGKILKR6E	63	09125-05046		REC09160-18028		09204-02004	
CM55321-93900A	51	09482-00649		PAGB/T899.1-M4	104	REC09160-20027	91	REC09204-02004	95
55321-93900		NGKILKR6E	8	09140-04007		09160-20027		09204-02004	
55320-93900		NGKMR6K-9	23	PAGB/T896-6	34	REC09160-20027	95	REC09209-08016	119
CM55321-94900	51	09482-00661		57292-94300	126	REC09160-20027	93	REC09209-08016	97
55320-94900		NGKMR6K-9	23	PAGB/T91-1.6X12	4	REC09160-20041	95	REC09209-08016	99
CM55321-94900A	8	09482-00661		09204-02001		09160-20041		09209-08016	
55320-94900		PAF115-08000002	34	PAGB/T91-1.6X12	4	REC09160-20041	95	REC09248-10008	101
CM55321-94900A	9	PAF15-01010007	37	PAGB/T93-6	101	REC09160-20041	91	REC09248-10008	103
55321-94900A		09159-22003/4/6		29162-93100		09160-20042		09248-10008	
CM5Z4050KITA	51	PAF15-07001000	20	PAGB/T93-6	103	REC09160-20042	91	REC09248-10008	104
CM5Z90140KITA	51	37820-93E10/11		29162-93100		09160-20042		09248-10008	
GS31090	10	PAF15-07080000	11	PAGB/T93-6	91	REC09160-20042	93	REC09248-10008	105
65770-93112		15410-94400		29162-93100		09160-20042		09248-10008	
GS31095	10	PAF15-07080002	11	PAGB/T93-6	93	REC09160-20043	91	REC09248-10008	107
65770-90J12		15413-87D10		29162-93100		09160-20043		09248-10008	
GS31187	10	PAF15-13010010W	34	PAGB/T97.1-8	99	REC09160-20043	93	REC09248-10008	109
65770-95541		67256-95600		PAJASOF404-19-033	4	REC09160-20043	95	REC09248-10008	117
GS90001	9	PAF166-010003	54	PRE3300C5	34	REC09160-20043	91	REC09248-10008	89
GS90008	9	09289-05006		PRE3300C6	34	09160-20043		09248-10008	
GS90009	9	PAF166-010003	55	PRE3300C7	34	REC09160-20043	95	REC09248-10008	109
GS90010	9	09289-05006		PRE3300C8	34	09160-20043		09248-10008	
GS90011	9	PAF166-010003	57	99105-11002-008		REC09160-20044	91	REC09248-10008	117
GS90012	9	09289-05006		PRE3300C9	34	09160-20044		09248-10008	
GS90013	9	PAF166-010003	59	99105-11002-009		REC09160-20044	93	REC09248-10008	89
GS90015	9	09289-05006		PRE3300C10	34	09160-20044		09248-10008	
GS90019	9	PAF166-010003	65	PRE3300C11	34	REC09160-20044	95	REC09248-10008	93
GS90025	9	09289-05006		99105-11002-010		09160-20044		09248-10008	
990F0-41005-OED		PAF166-010003	67	PRE3300C12	34	REC09160-20052	81	REC09248-10008	97
GS90032	9	09289-05006		99105-11002-011		09160-20052		09248-10008	
GS90042	9	PAF166-010003	68	PRE3300C13	34	REC09160-21009	91	REC09248-10008	99
990F0-41005-OEP		09289-05006		99105-11002-012		09160-21009		09248-10008	
GS90050	9	PAF166-010003	76	PRE3300C14	34	REC09160-21009	93	REC09262-25078	80
990F0-41005-YAY		09289-05006/12		99105-11002-013		09160-21009		09262-25078	
GS90051	9	PAF25-00000014	107	PRE3300C15	34	REC09160-21009	95	REC09262-25078	95
990F0-41005-Y5S		09202-08006		PRE3300C16	34	09160-21009		09262-25078	
GS90052	9	PAF25-00000014	109	99105-11002-015		REC09160-26015	101	REC09262-30055	80
990F0-41005-QTN		09202-08006		PRE3300C17	34	REC09160-27008	78	REC09262-30055	78
HR TITAN 3 PROP	127	PAF25-00000014	111	99105-11002-016		09160-27008		09262-30055	
LEXOR	127	09202-08006		PRE3300C18	34	REC09160-27008	81	REC09263-14022	81
NEW SATURN	127	PAF25-00000014	113	99105-11002-017		09160-27008		09263-14022	
NGKB5HS	22	09202-08006		PRE3300C19	34	REC09168-10022	101	REC09263-14022	81
NGKB6HS	22	PAF25-00000014	115	99105-11002-018		09168-10022		09263-14014	
NGKB7HS-10	22	09202-08006		PRE3300C20	34	REC09168-10022	103	REC09263-15019	121
NGKB7HS	22	PAF25-07000007W	34	99105-11002-019					

REC09263-20L04	122	REC09280-66004	113	REC09283-32048	75	REC09440-32008	93	REC11142-98L00	68
09263-20L04		09280-66004		09283-32048		09440-32008		11142-98L00	
09263-20024		REC09280-69001	107	REC09283-34014	57	REC09440-40002	101	REC11142-98L00	70
09263-20L04	91	09280-69001		09283-34014		09440-40002		11142-98L00	
09263-20024		REC09280-69001	109	REC09283-34014	75	REC09440-40002	103	REC11162-94410	79
09263-20L04	93	09280-69001		09283-34014		09440-40002		11162-94410	
09263-20L04		REC09280-69001	115	REC09283-34014	75	REC10W40	18	REC11179-93J00	67
09263-20L04	95	09280-69001		09283-34014		11141-87D90	79	11179-93J00	
09263-20L04		REC09280-75001	101	REC09283-35043	78	11141-87D90/61		REC11179-93J00	68
09263-20L04		09280-75001		09283-35043		REC11141-87D90	79	11179-93J00	
09263-22020	101	REC09280-75001	103	REC09283-35043	83	11141-87D61		REC11179-93J00	73
09263-22020		09280-75001		09283-35043		REC11141-87E90	79	11179-93J00	
09263-22020	103	REC09280-75001	119	REC09283-35047	75	11141-87E90/20		REC11189-87J00	58
09263-22020		09280-75001		09283-35047		REC11141-87E90	79	11189-87J00	
09263-22020	122	REC09280-75001	97	REC09283-37005	59	11141-87E20		REC11189-87J00	73
09263-22020		09280-75001		09283-37005		REC11141-87J02	58	11189-87J00	
09263-22L03	101	REC09280-92004	105	REC09283-37005	75	11141-87J02		REC11189-87L00	60
09263-22L03		09280-92004		09283-37005		REC11141-87J02	69	11189-87L00	
09263-22L03	103	REC09280-92004	119	REC09283-52025	75	11141-87J00/01/02		REC11189-87L00	73
09263-22L03		09280-92004		09283-52025		11141-87L00	60	11189-87L00	
09263-22L03	121	REC09280-97001	107	REC09283-52004	61	11141-87L00	69	REC11189-88L00	59
09263-22L03		09280-97001		09283-52004		11141-87L00		11189-88L00	
09263-22L03	81	REC09280-97001	109	REC09283-52004	75	11141-88L00	59	REC11189-88L00	73
09263-22L03		09280-97001		09283-52004		11141-88L00		11189-88L00	
09263-24018		REC09282-08005	111	REC09283-52006	62	11141-88L00	69	REC11189-90J00	61
09263-24018		09282-08005		09283-52006		11141-88L00		11189-90J00	
09263-25025	101	REC09282-10008	82	REC09283-52006	63	11141-88L00	69	REC11189-90J00	62
09263-25025		09282-10008		09283-52006		11141-89L00	55	11189-90J00	
09263-25025	121	REC09282-10008	89	REC09283-52006	75	11141-89L00	69	REC11189-90J00	63
09263-25025		09282-10008		09283-52006		11141-89L00		11189-90J00	
09263-25062	101	REC09282-12008	82	REC09283-91001	65	REC11141-90J01	61	REC11189-90J00	73
09263-25062		09282-12008		09283-91001		11141-90J01	61	11189-90J00	
09263-25062	121	REC09282-12010	54	REC09283-91001	67	11141-90J01	69	REC11189-93J00	67
09263-25062		09282-12010		09283-91001		11141-90J01		11189-93J00	
09263-25067	105	REC09282-12010	55	REC09283-91001	68	11141-90J01	69	REC11189-93J00	68
09263-25067		09282-12010		09283-91001		11141-91J10	69	11189-93J00	
09263-25067	112	REC09282-12010	82	REC09283-91001	75	11141-91J10	69	REC11189-93J00	73
09263-25067		09282-12010		09283-91001		11141-91J10/02		11189-93J00	
09263-25067	122	REC09282-15008	82	REC09283-91001	75	11141-92J01	62	REC11189-95J00	57
09263-25067		09282-15008		09283-91001		11141-92J01		11189-95J00	
09263-26023	104	REC09282-15010	115	REC09289-05008	56	REC11141-92J01	69	REC11189-95J00	73
09263-26023		09282-15010		09289-05008		11141-92J01		11189-95J00	
09263-26023	105	REC09282-17005	101	REC09289-05008	76	REC11141-93960	79	REC11189-96J00	61
09263-26023		09282-17005		09289-05008		11141-93950		11189-96J00	
09263-26023	122	REC09282-17005	103	REC09289-06003	61	REC11141-93960	79	REC11189-96J00	73
09263-26023		09282-17005		09289-06003		11141-93950		11189-96J00	
09263-26008		REC09282-17005	83	REC09289-06003	62	REC11141-93960	79	REC11219-95J01	57
09263-26008	78	09282-17005		09289-06003		11141-93950		11219-95J01	
09263-27005	81	REC09282-17006	82	REC09289-06003	63	REC11141-93960	79	REC11219-95J01	73
09263-27005		09282-17006		09289-06003		11141-93950		11219-95J01	
09265-17002	121	REC09282-17006	97	REC09289-06003	76	REC11141-93E20	69	REC11261-93J00	48
09265-17002		09282-17006		09289-06003		11141-93E20		11261-93J00	
09265-17002	97	REC09282-17007	101	REC09289-10005	89	REC11141-93J10	67	REC11261-93J00	55
09265-17002		09282-17007		09289-10005		11141-93J10		11261-93J00	
09265-17002	99	REC09282-17007	44	REC09289-10005	82	11141-93J10	70	REC11261-93J00	56
09265-17002		09282-17007		09289-10005		11141-93J03		11261-93J00	
09269-30012	78	REC09282-17009	59	REC09289-12002	82	REC11141-94450	79	REC11261-93J00	57
09269-30012		09282-17011		09289-12002		11141-94450		11261-93J00	
09269-30012	80	REC09282-17009	83	REC09289-12003	82	REC11141-94450	79	REC11261-93J00	58
09269-30012		09282-17009		09289-12003		11141-94440		11261-93J00	
09269-32002	111	REC09282-24003	61	REC09289-12003	93	REC11141-94506	79	REC11261-93J00	59
09269-32002		09282-24003		09289-12003		11141-94506/20		11261-93J00	
09269-32002	112	REC09282-24003	62	REC09289-17006	91	REC11141-94506	79	REC11261-93J00	60
09269-32002		09282-24003		09289-1702		11141-94620		11261-93J00	
09269-32002	113	REC09282-24003	63	REC09289-17006	93	REC11141-94720	79	REC11261-93J00	61
09269-32002		09282-24003		09289-17006		11141-94720		11261-93J00	
09269-32002	121	REC09282-24003	75	REC09289-17006	95	REC11141-94720	79	REC11261-93J00	62
09269-32002		09282-24003		09289-17102		11141-94720		11261-93J00	
09280-00040	111	REC09282-24003	75	REC09289-20009	82	REC11141-94J10	54	REC11261-93J00	63
09280-00040		09282-24003		09289-20009		11141-94J10		11261-93J00	
09280-00047	113	REC09282-24008	107	REC09289-20009	97	REC11141-94J10	69	REC11261-93J00	65
09280-00047		09282-24004		09289-20009		11141-94J10		11261-93J00	
09280-00047	115	REC09282-24008	109	REC09289-20009	99	REC11141-94L00	56	REC11261-93J00	67
09280-00047		09282-24004		09289-20009		11141-94L00		11261-93J00	
09280-00050	113	REC09282-24008	111	REC09289-22007	101	REC11141-94L00	69	REC11261-93J00	68
09280-00050		09282-24004		09289-22007		11141-94L00		11261-93J00	
09280-00050	119	REC09282-24008	113	REC09289-22007	103	REC11141-95505	79	REC11265-87E10	52
09280-00050		09282-24004		09289-22007		11141-95505		11265-87E00/H17	
09280-08005	117	REC09282-24008	115	REC09289-22007	83	11141-95505	79	REC11265-87E10	58
09280-08005		09282-24008		09289-22007		11141-95621		11265-87E10	
09280-13005	39	REC09282-25001	105	REC09289-24002	115	REC11141-95D40	79	REC11265-87E10	61
09280-13005		09282-25001		09289-24002		11141-95D40		11265-87E10	
09280-13005	61	REC09282-25001	119	REC09289-30008	82	REC11141-95D40	79	REC11265-87E10	62
09280-13005		09282-25001		09289-30008		11141-95D40		11265-87E10	
09280-21015	115	REC09282-28002	107	REC09380-15001	91	REC11141-95D40	79	REC11265-87E10	63
09280-21015		09282-28002		09380-15001		11141-95D40		11265-87E10	
09280-22019	5	REC09282-30006	111	REC09380-15001	93	REC11141-95J00	57	REC11265-87E10	63
09280-22019		09282-30006		09380-15001		11141-95J00		11265-87E10	
09280-22019	50	REC09282-30006	113	REC09380-15001	95	REC11141-95J00	69	REC11272-93J00	73
09280-22019		09282-30006		09380-15001		11141-95J00		11272-93J00	
09280-22019	52	REC09282-30007	109	REC09381-20003	78	REC11141-96303	79	REC11318-96J00	65
09280-22019		09282-30007		09381-20003		11141-96344		11318-96J00	
09280-22019	56	REC09282-30009	115	REC09420-03002	41	REC11141-96344	79	REC11318-96J00	72
09280-22019		09282-30009		09420-03002		11141-96344		11318-96J00	
09280-22019	58	REC09282-45001	115	REC09420-03002	89	REC11141-96344	79	REC11332-93J00	67
09280-22019		09282-45001		09420-03002		11141-96344		11332-93J00	
09280-22019	59	REC09283-10003	82	REC09420-03005	41	11141-96344	79	REC11332-93J00	73
09280-22019		09283-10003		09420-03005/0		11141-96J01	65	11332-93J00	
09280-22019	6	REC09283-10009	82	REC09420-03005	91	11141-96J01	69	REC11332-96J00	65
09280-22019		09283-10009		09420-03005		11141-96J01		11332-96J00	
09280-22019	60	REC09283-10011	107	REC09420-03005	95	11141-96L00	69	REC11332-96J00	73
09280-22019		09283-10011		09420-03005		11141-96L00		11332-96J00	
09280-22019	61	REC09283-10011	109	REC09420-04005	41	11141-96L00	69	REC11333-98L00	68
09280-22019		09283-10011		09420-04005		11141-96L00		11333-98L00	
09280-22019	62	REC09283-10011	112	REC09420-04006	101	11141-96L00	69	REC11333-98L00	73
09280-22019		09283-10011		09420-04006		11141-97J02		11333-98L00	
09280-22019	63	REC09283-17002	82	REC09420-04006	103	11141-97J02	69	REC1	

REC11410-94826	71	REC12140-93J00	77	REC13119-98J00	86	REC15100-99E11	13	REC16510-82703	17
11410-94820/173/6/7		12140-93J00		13119-98J00		15100-99E11		16510-82703	
REC11410-95811	57	REC12140-94400	78	REC13119-98L00	68	REC15170-91J00	14	16510-92J00	
11410-95811		12140-94400		13119-98L00		15170-91J00		16510-81420	
REC11410-96811	71	REC12140-94400	81	REC13119-98L00	86	REC15170-93911	14	REC16510-82703	18
11410-96811		12140-94400		13119-98L00		15170-93920		16510-87J00/10	17
REC11410-98831	71	REC12140-94400	81	REC13122-95J00	57	REC15170-94320	14	REC16510-87J00	18
11410-98830/31		12140-94400		13122-95J00		15170-94320		16510-87J00	18
REC11410-98841	68	REC12140-96361	81	REC13122-95J00	86	REC15170-94J00	14	REC16510-87J00	57
11410-98840/41		12140-96361		13122-95J00		15170-94J00		16510-87J00	
REC11410-98841	71	REC12140-96J00	65	REC13125-95210	16	REC15170-98110	14	REC16510-87J00	6
11410-98840/41		12140-96J00		13125-95200/10		15170-98110		REC16510-87J00	7
REC11413-87J00	58	REC12140-96J00	77	REC13125-95J00	16	REC15170-99E00	14	REC16510-90J00	17
11413-87J00		12140-96J00		13125-95J00		15170-99E00		16510-90J00	
REC11413-87J00	73	REC12140-96J10	65	REC13125-95J00	57	REC15200-92J20	13	16510-61A01/30/31	
11413-87J00		12140-96J10		13125-95J00		15200-92J00/20		16510-61A20-MHL	
REC11433-87J00	58	REC12140-96J10	77	REC13147-98J00	84	REC15200-96J00	13	16510-61A21-MHL	
11433-87J00		12140-96J10		13147-98J00		15200-96J00		REC16510-90J00	18
REC11433-87J00	73	REC12140-96J10	77	REC13200-91D21	16	REC15200-98L00	13	REC16510-90J00	7
11433-87J00		12140-96J10		13200-91D20/21		15200-98L00		REC16510-90J00	8
REC11433-93912	80	REC12140-98J10	67	REC13200-91J70	16	REC15410-87J00	12	16510-96J00/10	17
11433-93901		12140-98J10		13200-91J70		15410-87J10		REC16510-93J00	18
REC11433-94412	80	REC12140-98J10	68	REC13200-939D1	16	REC15410-87J10	11	REC16510-93J00	67
11433-94401		12140-98J10		13200-939D1		15410-87J10		16510-96J11	
REC11433-96330	80	REC12140-98J10	77	REC13200-93E12	16	REC15410-87J30	11	REC16510-93J00	68
11433-96302		12140-98J10		13200-93E11/12		15410-87J30		16510-96J11	
REC11434-94411	85	REC12140-99603	81	REC13250-93012	17	REC15410-87J30	7	REC16510-93J00	8
11434-94411		12140-99603		13250-93011/12		15410-87J30		16510-93J00	9
REC11489-87J00	58	REC12151-94400	78	REC13250-95D01	17	REC15410-87J30	6	REC16539-87L00	60
11489-87J00		12151-94400		13250-95D01		15410-87J30		16539-87L00	
REC11489-87J00	74	REC12161-93902	80	REC13250-98110	17	REC15410-87L00	11	REC16539-87L00	72
11489-87J00		12161-93902		13250-98100		15410-87L00		16539-87L00	
REC11489-87L00	60	REC12161-94400	78	REC13251-93320	16	REC15410-87L00	5	REC16910-6B2-005	
11489-87L00		12161-94400		13251-93310/20		15410-87L00		16410-94350	
REC11489-87L00	74	REC12161-94400	80	REC13251-95220	16	REC15410-88L00	6	REC17400-87B10	7
11489-87L00		12161-94400		13251-95210/20		15410-88L00		REC17400-87B20	6
REC11489-88L01	59	REC12211-94410	78	REC13251-98100	16	REC15410-88L00	6	REC17400-87D11	43
11489-88L01		12211-94410		13251-98100		15410-88L00		17400-87D00/10/11	
REC11489-88L01	74	REC12221-94412	78	REC13421-87J00	58	REC15410-93J00	11	REC17400-87D11	44
11489-88L01		12221-94412		13421-87J00		15410-93J00		REC17400-87E04	104
REC11489-90J00	61	REC12231-94413	78	REC13421-87J00	72	REC15410-93J11	11	REC17400-87E04	43
11489-90J00		12231-94413		13421-87J00		15410-93J10/11		17400-87E03	
REC11489-90J00	62	REC12232-94412	78	REC13421-90J02	61	REC15410-96J00	11	REC17400-87E04	44
11489-90J00		12232-94412		13421-90J02		15410-96J00		REC17400-87E04	7
REC11489-90J00	74	REC12240-94432	78	REC13421-90J02	62	REC15410-96J00	8	REC17400-87L01	105
11489-90J00		12240-94432		13421-90J02		15410-96J00		17400-87L01	
REC11489-93E11	54	REC12281-87J00	59	REC13421-90J02	72	REC15410-98500	11	REC17400-87L01	43
11489-93E11		12281-87J00		13421-90J02		15410-98500		17400-87L01	
REC11489-93E11	70	REC12281-87J00	75	REC13421-98J00	72	REC15410-98500	4	REC17400-87L01	43
11489-93E11		12281-87J00		13421-98J00		15410-98500		17400-87L01	
REC11489-93E11	74	REC12281-87J00	83	REC13640-32G20	20	REC15412-92J00	11	REC17400-87L01	44
11489-93E11		12281-87J00		13640-32G20		15412-92J00		REC17400-87L01	7
REC11489-93J00	67	REC12472-98L00	68	REC13650-52G00	19	REC15412-92J00	7	REC17400-88810	6
11489-93J00		12472-98L00		13650-52G00		15412-92J00		17400-88L00	103
REC11489-93J00	74	REC12710-97J00	74	REC13650-56B00	19	REC15412-93J10	11	REC17400-88L00	43
11489-93J00		12710-97J00		13650-56B00		15412-93J10		17400-88L00	
REC11489-95J01	57	REC12730-96J01	75	REC13855-95210	86	REC15412-93J10	8	REC17400-88L00	44
11489-95J01		12730-96J00/1		13855-95200/10		15412-93J10		REC17400-88L00	6
REC11489-95J01	70	REC12761-72F00	77	REC13910-87D00	17	REC15440-87L10	12	REC17400-88L00	44
11489-95J01		12761-72F00		13910-87D00		15440-87L10		REC17400-88L00	6
REC11489-96J01	65	REC12761-93E10	54	REC13910-89J01	17	REC15440-90J00	12	REC17400-88L00	5
11489-96J01		12761-93E10		13910-89J01		15440-90J00		REC17400-89B20	6
REC11489-96J01	74	REC12761-93E10	55	REC13910-94400	17	REC15440-93J00	12	REC17400-90B12	42
11489-96J01		12761-93E10		13910-94400		15440-93J00		17400-90B10/11/12	
REC11489-98L00	68	REC12761-93E10	77	REC13910-94701	17	REC15440-96J00	12	17411-90J00	
11489-98L00		12761-93E10		13910-94701		15440-96J00		REC17400-90J20	107
REC11489-98L00	74	REC12761-94L10	56	REC14141-93952-OEP	85	REC15440-96J01	12	17400-90J20	
11489-98L00		12761-94L10		14141-93952-OEP		15440-96J01		17400-90J11	43
REC11542-87L00	60	REC12761-94L10	77	REC14151-87L00	60	REC15440-99E01	12	REC17400-90J20	44
11542-87L00		12761-94L10/10		14151-87L00		15440-99E01		17400-90J11	
REC11542-87L00	84	REC12761-99J00	77	REC14151-87L00	84	REC15626-88L01	14	REC17400-90J20	44
11542-87L00		12761-99J00		14151-87L00		15626-88L00/01		REC17400-91B30	5
REC11552-87L00	44	REC12778-93J00	72	REC14151-88L00	59	REC15626-90J00	14	REC17400-91B60	4
11552-87L00		12778-93J00		14151-88L00		15626-90J00		REC17400-91B91	4
REC11552-88L00	44	REC12911-86FA2	61	REC14151-88L00	84	REC15626-92J01	14	REC17400-92B21	7
11552-88L00		12911-86FA2		14151-88L00		15626-92J01/1		REC17400-92B40	7
REC11552-88L00	59	REC12911-86FA2	62	REC14151-90J00	61	REC15626-93J00	14	REC17400-92B50	8
11552-88L00		12911-86FA2		14151-90J00		15626-93J00		17400-92D01/11	43
REC11552-96J00	44	REC12911-86FA2	63	REC14151-90J00	62	REC15626-96J00	14	REC17400-92D01	44
11552-96J00		12911-86FA2		14151-90J00		15626-96J00		REC17400-92J00	109
REC11552-96J00	65	REC12911-86FA2	76	REC14151-90J00	63	REC15626-99E00	14	17400-92J00	
11552-96J00		12911-86FA2		14151-90J00		15626-99E00		REC17400-92J00	43
REC12110-93130K	81	REC12911-88L00	59	REC14151-90J00	84	REC15643-99E00	12	REC17400-92J00	44
12110-93130		12911-88L00		14151-90J00		15643-99E00		REC17400-92J21	107
REC12110-94350K	81	REC12911-88L00	76	REC14151-93912	85	REC15647-93J00	16	17400-92J21	
12110-94350		12911-88L00		14151-93912		15647-93J00		REC17400-92J21	109
REC12110-94400K	78	REC12911-93J00	65	REC14151-93J00	67	REC15710-65D00	15	REC17400-92J21	43
12110-94400K		12911-93J00		14151-93J00		15710-65D00		REC17400-92J21	44
REC12110-94400K	81	REC12911-93J00	67	REC14151-93J00	84	REC15710-65D00	15	REC17400-92J21	7
12110-94400K		12911-93J00		14151-93J00		15710-65D00		REC17400-92J21	4
REC12111-97J10	57	REC12911-93J00	76	REC14151-94411	85	REC15710-66D00	15	REC17400-92J21	7
1111-97J10-080		12911-93J00		14151-94412		15710-66D00		REC17400-92J21	4
REC12140-02C10	77	REC12911-98J00	67	REC14151-96311	85	REC15710-82K50	15	REC17400-93B51	8
12140-02C10		12911-98J00		14151-96310		15710-82K50		17400-93B11/12	43
REC12140-02C10	77	REC12911-98L00	68	REC14151-96J00	65	REC15710-82K50	15	REC17400-93951	43
12140-02C10		12911-98L00		14151-96J00		15710-82M00		17400-93950	
REC12140-75F30	57	REC12911-98L00	76	REC14151-96J00	84	REC15710-82M00	15	REC17400-93951	44
12140-75F30		12911-98L00		14151-96J00		15710-82M00		REC17400-93951	93
REC12140-75F30	77	REC12911-98L00	76	REC14152-93J00	67	REC15710-85K00	15	17400-93951	
12140-75F30		12911-98L00		14152-93J00		15710-85K00		REC17400-93J01	112
REC12140-86FA0	61	REC12915-73G20	59	REC14212-91L00	85	REC15710-87J00	15	REC17400-93J01	44
12140-86FA0		12915-73G20		14212-91L00		15710-87J00		17400-93J00/1/2/3	
REC12140-86FA0	77	REC12915-73G20	76	REC14212-93J00	67	REC15710-87L00	15	REC17400-93J01	8
12140-86FA0		12915-73G20		14212-93J00		15710-87L00		REC17400-94611	43
REC12140-87J01	77	REC12915-86FA1	61	REC14212-94413	85	REC15710-87L00	15	REC17400-94611	44
12140-87J01		12915-86FA1		14212-94412		15710-87L00		REC17400-94611	44

REC17400-96403	43	REC17413-99E11	104	REC17461-95300	40	REC17472-93J00	112	REC18590-58M00	19
17400-96350/1/2/3		17413-99E10		17461-95501		17472-93J00		18590-58M00	
17400-96403	44	REC17413-99E11	105	REC17461-95300/1/2	101	REC17472-93J00	45	REC18590-68H00	19
REC17400-96403	6	17413-99E10		REC17461-96312	103	17472-93J00		18590-68H00	
REC17400-96403	99	REC17413-99E11	45	17461-96312		REC17472-95310	45	REC18590-72F21	15
17400-96352	8	17413-99E10		REC17461-96312	103	17472-95310		REC18590-72F21	19
REC17400-96821	8	17416-92J00	107	17461-96312		REC17472-96303	101	18590-72F21	
REC17400-96832	8	17416-92J10	107	17461-96312	40	17472-96303		18590-68H00	
REC17400-96J03	111	17416-92J10	109	17461-94100		REC17472-96303	103	REC18590-72F21	65
17400-96J03	44	17416-92J10		REC17461-96312	40	17472-96303		18590-72F21	
REC17400-96J03/1/2/3	44	REC17416-92J10	44	17461-96301		REC17472-96303	45	REC18590-80C40	19
REC17400-96J03	8	17416-92J10		REC17461-96312	40	17472-96301/2/3		18590-80C40	
REC17400-97810	4	REC17416-93J00	112	17461-96301		REC17472-96303	97	REC23211-94401	120
REC17400-97820	4	17416-93J00		REC17461-96312	40	17472-96303		23211-94401	
REC17400-98551	43	REC17416-93J00	113	17461-96301		REC17472-96303	9	REC25222-93901	117
17400-98551	44	REC17416-93J00	115	REC17461-96312	40	17472-96303		25222-93901	
REC17400-98551	44	17416-93J00		REC17461-96312	40	REC17472-97J00	4	REC25222-96300	117
REC17400-98652	43	REC17416-93J00	44	17461-96312		17472-97J00		25222-96300	
REC17400-98652/2/61	44	REC17416-93J00	103	REC17461-96312	40	REC17472-97J00	45	REC25700-87L00	116
REC17400-98652	44	17416-93J00		17461-96312		REC17472-97J00	4	25700-87L00	
REC17400-98661	4	REC17416-95J00	44	REC17461-96312	40	17472-97J00		REC25700-87L00	117
REC17400-98661	43	17416-95J00		17461-96312		REC17472-98503	45	REC25700-88L00	116
17400-98661/1	44	REC17416-95J00	97	REC17461-96312	99	17472-98503		REC25700-88L00	
REC17400-98661	44	17416-95J00		17461-96312-HP	40	17472-98611	45	REC25700-88L00	117
REC17400-98661	5	REC17416-96J00	111	17461-96312		REC17472-98J00	113	REC25700-90J01	116
REC17400-98661	89	17416-96J00		17461-94100		17472-98J00		25700-90J01	
17400-98661	9	REC17416-96J00	44	REC17461-96312-HP	40	REC17472-98J00	45	REC25700-90J01	117
REC17400-98861	9	17416-96J00		17461-96301		REC17472-98J00	4	REC25700-92J00	116
REC17400-98875	9	REC17416-99E10	105	REC17461-96312-HP	40	REC17472-98J00	115	REC25700-92J00	117
REC17400-98J01	113	17416-99E10		17461-96301		REC17472-98L00	45	REC25700-93J00	116
REC17400-98J01	44	REC17416-99E10	44	REC17461-96312-HP	40	17472-98L00		REC25700-93J00	117
17400-98J01/1/2	44	17416-99E10		17461-96301		REC17560-91L00	118	REC25700-93L00	116
REC17400-98J01	44	REC17417-92J00	107	REC17461-96312-HP	40	17560-91L00		25700-93L00	
REC17400-98J01	44	17417-92J00		17461-96301		REC17563-94400	101	REC25700-93L00	117
REC17400-98J01	9	REC17417-92J00	44	REC17461-96312-HP	40	17563-94400		REC25700-95010	117
REC17400-98L03	115	17417-92J00		17461-96312		REC17563-94400	39	REC25700-95010	116
17400-98L03	44	REC17431-92L20	118	REC17461-96312-HP	4	17563-94400		25700-95010/1	
REC17400-98L03	9	17431-94440/1	42	REC17461-97J00	4	REC17563-94400	115	REC25700-95010	117
REC17400-98L03	5	REC17450-93921	93	17461-97100		17563-94400		25700-95J00	
REC17400-98L03	7	17450-93920/21/30	42	REC17461-98503	40	REC17564-93J01	39	REC25700-95J00	117
REC17400-98L03	9	17450-93440	93	17461-98503		17564-93J01		25700-95J00	
REC17400-98840	5	REC17450-93921	45	REC17461-98503	40	REC17565-94400	101	REC25700-95J00	116
REC17400-98870	43	17452-93910	93	REC17461-98503/2/3	41	17565-94900	39	REC25700-98J00	117
REC17400-99J01	7	REC17452-93910	45	REC17461-98503	89	17565-94900		25700-98J00	
REC17400-99J01	44	17452-93910	93	REC17461-98503-HP	40	REC17566-94400	101	REC25700-98L01/2/4/5	116
REC17400-99J01	5	REC17452-93910	118	17461-98503		17566-94400	39	REC25700-99E00	117
REC17400-99J01	91	REC17453-93901	93	REC17461-98503-HP	40	REC17566-94400	58	REC25700-99E00	116
REC17400-99J01	95	17453-93900/01	104	17462-93990	41	17566-94400		25700-99E00	
REC17410-88L00	103	REC17461-87E12	104	REC17462-93990	93	REC17616-87J00	73	REC26-161622	83
REC17410-88L00	42	17461-87E12		17462-93990		17616-87J00		09289-17004	
REC17410-88L00	107	REC17461-87E12	40	REC17471-87D01	41	REC17660-90J00	39	REC2T	18
17410-88L00	42	17461-87E10/11/12	40	17471-87D00/01		17660-90J00		REC31100-87J00	24
REC17410-92J00	107	REC17461-87E12	40	REC17471-87L01	41	REC17660-99E01	39	31100-87J00/10/11	
REC17410-92J00	112	17461-87E10/11/12	40	17471-87L01		17660-99E01		31100-87500	
REC17410-92J00	42	REC17461-87E12-HP	40	REC17471-87J00	104	REC17660-99E01	67	REC31100-87J11	24
REC17410-93J01	113	17461-87E10/11/12	40	17471-87J00		17660-99E01		31100-87J10/11	
REC17410-93J01	113	REC17461-87E12-HP	40	REC17471-87E01	107	REC17670-87J00	38	REC31100-89J00	24
REC17410-93J01	115	REC17461-87E12-HP	107	17471-87E01		17670-87J00		3100-89J00	
REC17410-93J01	42	REC17461-90J01	109	REC17471-92J00	107	REC17670-90J10	38	REC31100-89L00	23
REC17410-93J01	42	17461-90J01		17471-92J00		17670-90J10		31100-92L00	
REC17410-95J00	42	REC17461-90J01	111	REC17471-92J00	109	REC17670-91J01	38	REC31100-90J01	24
REC17410-95J00	97	17461-90J01		17471-92J00		17670-91J01		31100-90J00/1	
REC17410-95J00	42	REC17461-90J01	40	REC17471-92J00	41	REC17670-93962	38	REC31100-92E00	24
REC17410-95J00	105	17461-94510		17471-92J00		17670-93962		31100-87D00/10	
REC17410-99E10	105	REC17461-90J01-HP	40	REC17471-92J00	111	REC17670-94402	38	31100-87D00/10	
REC17410-99E10	42	17461-90J01		17471-92J00		17670-94402		31100-92E00	
REC17411-93901	42	REC17461-90J01-HP	40	REC17471-92J02	41	REC17670-94J01	38	REC31100-92J00	24
REC17411-93901/10	93	17461-90J01		17471-92J02		17670-94J01		31100-94610	
REC17411-93901	101	REC17461-92D02	40	REC17471-93J00	41	REC17670-94J01	39	31100-94600/10	
REC17411-94421	101	17461-92D02		17471-93J00		17670-94J01		31100-94500/10/11/12	
REC17411-94421	42	REC17461-92D02	40	REC17471-93J00/1/2	41	REC17685-87D00/10	58	REC31100-94702	24
REC17411-94421/31	99	17461-92D02		17471-93J00/1/2		17685-87D00/10		31100-94702	
REC17411-94421	99	REC17461-92D02-HP	40	REC17471-93902	93	REC17685-87D10	58	REC31100-94722	23
REC17411-94J00	42	REC17461-92D02-HP	40	17471-93902		17685-87D10		31100-94100/20/21/22	
17411-94J00	91	17461-92D02		REC17471-94401	101	17685-94410	39	REC31100-95601	24
REC17411-94J00	91	REC17461-93004	40	17471-94401		17685-94410		31100-95600/1	
REC17411-94J00	95	17461-93001/3/4	40	REC17471-94401	41	REC17693-95J00	72	31100-95601/12/13	
REC17411-94J00	95	REC17461-93004	40	17471-94401		17693-95J00		31100-95521	
REC17411-94L00	42	REC17461-93004	40	REC17471-95J01	99	REC17913-93J00	39	REC31100-95J01	23
REC17411-94L00	111	17461-93001/2/3/4	40	17471-95J01		17913-93J00		31100-95J00/01	
REC17411-96J01	42	REC17461-93004	40	REC17471-95J01	103	REC17913-93J00	55	31100-94100/20/21/22	
REC17411-96J01	42	17461-93002		17471-95J01		17913-93J00		31100-96J00/1	
REC17411-96J01/2/3/4	107	REC17461-93903	40	REC17471-97J00	4	REC17913-93J00	59	31100-96J00/1	
REC17413-92J01	109	17461-93903		17471-97J00		17913-93J00		31100-93J00	
REC17413-92J01	45	REC17461-93903	93	REC17471-97J00	41	REC17913-93J00	62	31100-98L00/10	24
REC17413-92J01	113	17461-93903		17471-97J00		17913-93J00		31100-98L10	
REC17413-93J02	115	REC17461-93903-HP	40	REC17471-97J10	41	REC17913-93J00	63	REC31100-98L10	24
REC17413-93J02	45	17461-93901/2/3	112	17471-97J10		17913-93J00		31100-98L10	
REC17413-93J02	9	REC17461-93J00	113	REC17471-98601	41	REC17913-93J00	65	REC31100-94L01	24
REC17413-94J00	4	17461-93J00	115	17471-98610		17913-93J00		31100-94L01	
REC17413-94J00	91	REC17461-93J00	40	REC17471-98610	89	REC17914-93J00	62	REC31100-94L01	24
REC17413-94J00	95	17461-93J00		17471-98610		17914-93J00		32140-93900	
REC17413-94L00	45	REC17461-94700-HP	40	REC17471-98L00	115	REC17914-93J00	68	REC32140-94400	21
REC17413-95J00	103	17461-94700/1	40	17471-98L00		17914-93J00		32140-94400	
REC17413-95J00	45	REC17461-94700	40	REC17471-98L00	45	REC17914-93J00	65	REC32140-96310	21
REC17413-95J00	6	17461-95201	40	REC17471-98L00	45	17914-93J00		32140-96310	
REC17413-95J00	97	REC17461-94700-HP	40	REC17471-98L00	45	REC17914-93J00	67	REC32800-38F10	25
REC17413-96J01	111	17461-94700/1	40	REC17472-87E10	104	REC17914-93J00	59	REC32800-38F10	26
REC17413-96J01	45	17461-95200	40	17472-87E10		17914-93J00		32800-38F10	
REC17413-96J01	8	REC17461-94700-HP	40	REC17472-87E10	107	REC17914-93J00	55	REC32800-87J10	25
REC17413-97J00	45	17461-94701	40	17472-87E10		17914-93J00		32800-87J10	
REC17413-97J00	45	REC17461-94700-HP	40	REC17472-87E10	109	REC17914-93J00	62	REC32800-87L00	26

REC32800-94J01	26	REC38100-87E10-OED	27	RECS51211-89L00	70	REC55320-94900	48	RECS6130-96331-OEP	42
32800-94J00/01		38100-87E10/01/02H		51211-89L00		55320-94900		56130-96331-OEP	
REC32800-94J11	25	38100-87E10-OED		RECS51211-90J10	61	REC55320-94900	52	56130-96320-OEP	
32800-94J10/11		38100-87E10-OED/02M		51211-90J10		REC55320-94900AL	48	REC56132-95J00	45
REC32800-95D01	25	REC38100-87J0E	27	RECS51211-90J10	70	55320-94900		56132-95J00	
32800-95D00/1		38100-87J0E/OEP		51211-90J00/01/02/10		REC55320-94900AL	9	REC56132-95J00	97
REC32800-95D01	26	REC38100-87J12	27	RECS51211-90J2	61	REC55320-95311	47	REC56132-95J00	
32800-95720/1		38100-87J11/20		51211-90J20		55320-95311		REC56132-95J00	
REC32800-98J01	25	REC38100-87L12	28	RECS51211-90J2	62	REC55320-95311AL	111	REC57100-93902	124
32800-98J01		38100-87L12/13		51211-90J22		55320-95311		REC57100-93902	93
REC32800-98J01	26	REC38100-96J00	28	RECS51211-90J2	70	REC55320-95311AL	112	REC57100-93J21	112
32800-99J00		38100-92J01/02/10/12		51211-90J22/2		55320-95311		REC57100-93J21	112
REC32800-99J00	26	38100-96J00/01		RECS51211-90J30	63	REC55320-95311AL	113	REC57100-93J31	112
32800-99J00		38100-96J00/OEP		51211-90J30		55320-95311AL		REC57100-93J31	117
REC32900-93903	21	REC38100-97E00-OED	27	RECS51211-90J30	70	REC55320-95311AL	115	REC57100-93J31	117
32900-93902/3		38100-97E00-OED		51211-90J30		55320-95311AL		57100-93J31	
REC32900-93910	25	REC38100-98L00	28	RECS51211-93J00	67	REC55320-95311AL	47	REC57100-94411	124
32900-93911		38100-98L00/01/02		51211-93J00		55320-95311		REC57100-94411	124
REC32900-94460	25	REC38100-99E01-OEP	27	51211-93J00	70	REC55320-95311AL	52	REC57100-94431	118
32900-94460/70		38100-99E01-OEP/OED		51211-93J00		REC55320-98400	48	57100-94301	
REC32900-94480	21	38100-99E01-00	31	RECS51211-94L00	70	55320-98400		REC57300-93860	112
32900-94401/21/80		REC38410-93J12	31	51211-94L00		REC55320-98400AL	48	57300-93860	
REC32900-96340	21	38410-93J11/10/00	31	RECS51211-96J00	65	55320-98400		REC57300-96810	111
32900-96340		REC38410-93J20/21	31	51211-96J00		REC55321-87J01	47	57300-96810	
REC32900-96371	25	REC38860-76F01	25	RECS51211-96J00	70	REC55321-87J01	48	REC57300-96850	111
32900-96370/71		38860-76F01		51211-96J00		55321-87J01		57300-96850	
REC32900-96350	20	REC41151-94500	37	RECS51211-98L00	68	REC55321-87J01	52	REC57311-93901	122
32920-50M00		41151-94500		51211-98L00		REC55321-87J01AL	103	57311-93901	
REC32920-58J20	20	REC41212-93001-OEP	37	51211-98L00		55321-87J01		REC57311-93901	122
32920-58J20		41212-93001-OEP/OED		RECS52113-93910	85	55321-87J01	105	57311-93910	
REC32920-64L00	20	41212-93900-OED		RECS52113-96330	85	REC55321-87J01AL	4	REC57311-93910	124
32920-64L00		REC43211-87J10	37	52113-96304		REC55321-87J01AL	48	57311-93910	93
REC32920-76G02	20	43211-87J10		RECS521-B25F	87	55321-87J01		57311-93910	
32920-76G00/1/2		43211-94401		50040-93839-OEP		REC55321-87J01AL	5	REC57311-94402	122
REC32920-84M10	20	REC43211-94401	37	50040-93840-OEP		55321-87J01		57311-94402/2	
32920-84M10		REC43711-97E11	37	RECS521-B30F	87	REC55321-87J01AL	56	REC57311-94402	124
REC32920-98J00	20	43711-97E00/11		50060-93839-OEP		55321-87J01		57311-94402/1	
32920-98J00		REC48326-95E00	29	50060-93851-OEP		REC55321-87J01AL	57	REC57311-96310/11/20	122
REC33410-87J01	21	REC48401-93J11	29	RECS2331-87L00	60	55321-87J01		57311-96310	
33410-87J00/01		REC48401-93J11	30	52331-87L00		REC55321-87J01AL	58	57311-96310	
REC33410-87L00	21	48401-93J11		RECS2331-87L00	60	55321-87J01AL	58	REC57311-96311	124
33410-87L00		48401-93L00		52331-87L00		REC55321-87J01AL	59	REC57311-96320	122
REC33410-89L11	21	REC48401-98L00	29	RECS28-B25F	87	55321-87J01		57311-96320	
33410-89L00/10/11		48401-98L00	30	50040-93829-OEP		REC55321-87J01AL	6	REC57311-96320	97
REC33410-90J00	21	REC48401-98L00	30	50040-93851-OEP		REC55321-87J01AL	60	57311-96320	
33410-90J00		48400-93J07		RECS28-B30F	87	55321-87J01		REC57311-96320	99
REC33410-93J00	21	48400-98J03		50060-93829-OEP		REC55321-87J01AL	61	57311-96320	
33410-93J00		REC48503-93J12	28	50060-93851-OEP		55321-87J01		REC57311-98400	122
REC33410-94400-000	21	48503-93J10/12		RECS4130-96320	36	REC55321-87J01AL	62	57311-98400	124
33410-94400-000		48503-94900-OED		54130-96310/20		55321-87J01		REC57311-98400	122
REC33410-94J00	21	REC48503-93J12	29	RECS4160-94410	36	REC55321-87J01AL	63	57311-98600/1	89
33410-94J00		48610-98L00	29	54160-94410		55321-87J01		57311-98600	
REC33410-94L00	21	48610-98L00	29	RECS5120-87801	49	REC55321-87J01AL	65	57311-98600	122
33410-94L00		48630-92J00	29	55120-87801		55321-87J01		57311-98600	
REC33410-95J00	21	REC48630-92J00	30	RECS5120-87801AL	49	REC55321-87J01AL	67	57311-98600	122
33410-95J00		48630-92J00		55120-87801		55321-87J01		57311-98600	
REC33410-96L00	21	REC48630-92J00	30	RECS5122-93L00	121	REC55321-87J01AL	68	57311-98600	122
33410-96L00		48630-92J00		55122-93L00		55321-87J01		57311-98600	
REC33410-96L00	63	REC48630-93J00	30	RECS5122-94400	103	REC55321-87J01AL	7	57311-98600	123
33410-96L00		48630-93J00		55122-94400		55321-87J01		57311-98600	
REC34801-93J03	31	48630-94900	29	RECS5122-98L00	115	REC55321-87J01AL	8	57311-98600	123
34801-93J01/2/3		REC48630-94900	30	55122-98L00		55321-87J01		57311-98600	
REC34801-94710	31	48630-94900	30	RECS5122-98L00	121	REC55321-87J01AL	9	57311-98600	124
34801-94700/10		REC48630-96J00	29	55122-98L00		REC55321-87J01AL	91	57311-98600	97
REC34801-99E04	31	48630-96J00	30	RECS5125-90J01	47	55321-87J01		57311-98600	
34801-99E01/2/3/4		48630-96J00	29	55125-90J01		REC55321-87J01AL	93	57311-98600	99
REC34830-87J20	20	REC48630-96J03	29	55125-90J01	49	55321-87J01		57311-98600	123
34830-87J20		48630-96J03		RECS5125-90J01AL	104	REC55321-87J01AL	95	57311-98600	123
REC34840-87L01	31	REC48630-96J03	30	55125-90J01		55321-87J01		57311-98600	
34840-87L00/01		48630-96J01/2/3		RECS5125-90J01AL	105	REC55321-90J01	47	57311-98600	124
REC34840-98J03	31	REC48630-98L01	29	55125-90J01AL	107	55321-90J01	48	57311-98600	124
34840-98J00/1/2/3		48630-98L01	30	RECS5125-90J01AL	109	REC55321-90J01AL	104	57311-98600	89
REC34840-98J11	31	REC50-8M0147039	23	55125-90J01		55321-90J01		57311-98600	
34840-98J11		31100-96310/11		RECS5125-90J01AL	109	55321-90J01	107	57311-98600	124
REC36120-ZW4-H12	27	31100-96310/01/2		55125-90J01		REC55321-90J01AL	109	57311-98600	123
36120-ZY3-013		31100-89J00		RECS5125-90J01AL	111	55321-90J01	48	57311-98600	124
REC36120-90J30/40	27	31100-95D00		55125-90J01		REC55321-90J01AL	48	57311-98600	123
36120-90J30/40		RECS1116-93J01	67	RECS5125-90J01AL	112	55321-90J01		57311-98600	
REC36120-ZY6-013	27	51116-93J01		RECS5125-90J01AL	49	REC55321-90L00	47	57311-98600	124
36120-ZY6-013/30/40		RECS1123-87L00	60	55125-90J01		55321-90L00	48	57311-98600	93
REC36120-ZY9-003	27	51123-87L00		RECS5125-91L01	47	REC55321-90L00A	48	57311-98600	123
36120-87L00/1/2/3		RECS1123-87L00	72	55125-91L01		55321-90L00A		57311-98600	
REC36620-93J02	36	51123-87L00		RECS5125-91L01AL	49	55321-90L00	48	57311-98600	124
36620-93J02		RECS1123-88L00	59	55125-91L01AL		55321-90L00		57311-98600	
REC36620-93J12	36	51123-88L00		RECS5125-91L01AL	49	REC55321-90L00A	93	57311-98600	123
36620-93J12		RECS1123-88L00	72	55125-91L01AL		41811-98500	47	57311-98600	
REC36620-93J62	36	51123-88L00		RECS5125-91L01AL	97	REC55321-939L0AL	93	57311-98600	124
36620-93J62		RECS1123-93J00	67	55125-96310		55321-93900		57311-98600	
REC36620-94J01	36	51123-93J00		RECS5125-91L01AL	99	REC55321-95J00	47	57311-98600	123
36620-94J01		RECS1123-93J00	72	55125-96310		55321-95J00		57311-98600	
REC36620-98J33	36	51123-93J00		RECS5125-94502	49	REC55321-95J00AL	47	57311-98600	99
36620-98J33		RECS1123-96J02	65	55125-94502		55321-95J00		57311-98600	
REC36620-98L00	36	51123-96J02		RECS5125-95500	47	55321-95J00		57311-98600	
36620-98L00		RECS1123-96J02	72	55125-95500		REC55321-95J00AL	47	57311-98600	99
REC37100-96J15	35	51123-96J01/2		55125-95500	49	55321-95J00		57311-98600	
37100-96J14/15		RECS1123-98L00	68	55125-95500		REC56120-87L30-OEP	105	57311-98600	123
REC37100-96J25	35	51123-98L00		RECS5125-95500AL	101	56120-87L30-OEP		57311-98600	
37100-96J21/22/23/24/25		RECS1123-98L00	72	55125-95500		56120-87L30-OEP		57311-98600	
REC37110-93J11	35	51123-98L00		RECS5125-95500AL	103	56120-92L01-OEP	109	57311-98600	123
37110-93J10/11		RECS1124-93J01	65	55125-95500		56120-92L01-OEP		57311-98600	
REC37110-99E00	35	51124-93J01		RECS5125-95500AL	49	56120-92L01-OEP	118	57311-98600	124
37110-99E00		RECS1124-93J01	68	55128-87E01		56120-92L01-OEP		57311-98600	
REC37220-92E00	30	51124-93J01		55128-87E01		REC56120-93900	118	57311-98600	123
37220-92E00		RECS1124-93J01	75	55128-93J10	111				

REC57610-94402	126	REC61616-93ELO	37	REC90171-18M04	115	SOL3451-139-21	128	SOL4551-148-16	129
57610-94402		61616-93ELO		90171-18M04		58100-9020-019		99105-00200-16P	
REC57610-96311	126	61616-93E00		REC90171-18M04	126	SOL3451-139-21	128	SOL4551-148-20	129
57610-96311		REC61N-44146-00	117	09141-18005		99105-00700-22P		58200-87D11-019	
REC57610-96311	97	23311-95D10		REC90179-08M06	97	SOL3451-139-23	128	SOL4551-148-20	129
57610-96311		REC63610-99E01	34	09159-08046		58100-9022-019		99105-00200-20P	
REC57610-96311	99	63610-89E01-000		REC90179-08M06	99	SOL3451-139-23	128	99105-0020L-24P	129
57610-96311		REC63610-91J20	34	09159-08046		99105-00700-24P		SOL4552-148-16	129
REC57621-91L10	119	63610-91J20		REC90794-46913	11	SOL3452-139-17	128	58200-87D62-019	129
57621-91L10		63610-91000/1/3/4		65910-98J00		99105-0070L-18P			
REC57621-92J20	109	REC63610-93S01	34	REC91490-30025	101	SOL3452-139-19	128	SOL4552-148-16	129
57621-92J20		63610-93501-000		09204-03003		99105-0070L-20P		99105-0020L-16P	
REC57621-92J20	119	REC63610-94402	34	REC91490-30025	103	SOL3452-139-21	128	SOL4552-148-18	129
57621-92J20		63610-94402-000		09204-03003		99105-0070L-22P		58200-87D02-019	
REC57621-94403	101	REC63610-96302	34	REC91490-30025	104	SOL4011-079-07S	128	SOL4552-148-18	129
57621-94403		63610-96302-000		09204-03003		58110-91JN0-019		99105-0020L-18P	
REC57621-94403	103	REC63610-96321-000	34	REC91490-30025	105	SOL4011-079-07S	89	SOL4552-148-20	129
57621-94403		63610-96321-000		09204-03003		58110-91JN0-019		58200-87D12-019	
REC57621-94403	119	REC63P-13907-03	13	REC91490-30025	107	SOL4111-093-07A	128	SOL4552-148-20	129
57621-94403/3		15200-90J00/01		09204-03003		58100-89L00-019		99105-0020L-20P	
REC57621-94403	119	REC63P-13915-00	12	REC91490-30025	109	SOL4111-093-08A	128	SOL4571-148-23	129
57621-94403/1/2/3		15642-88L00		09204-03003		58100-90L41-019		SOL4571-149-22	129
REC57621-94403	124	REC63P-14984-00	13	REC91490-30025	111	SOL4111-093-09A	128	SOL4571-151-20	129
57621-94403		48600-94511-0EJ		09204-03003		58100-89L20-019		SOL4571-154-18	129
REC57630-90J00	109	REC63P-43800-20	28	REC91490-30025	112	SOL4111-093-10A	128	SOL4572-149-22	129
57630-90J00		48600-94511-0EJ		91490-30025		58100-89L60-019		SOL4572-151-20	129
REC57630-90J00	125	REC64E-43811-02	29	REC91490-30025	113	SOL4111-093-11A	128	SOL4572-154-18	129
57630-90J00		48401-96J02		09204-03003		58100-89L70-019		SOL4652-155-180	129
REC57630-90J00	91	REC64E-43820-05	29	REC91490-30025	115	SOL4111-093-12A	128	58500-98L90	
57630-90J00		48600-94511-0EJ		91490-30025		58100-89L80-019			
REC57630-92E00	111	REC64E-43822-00	29	REC91490-30025	126	SOL4211-100-14	128	SOL4652-155-195	129
57630-92E00		REC64E-43841-00	29	09204-03003		58100-95D00-019		58500-98L60	
REC57630-92E00	112	REC65720-94403	10	REC91490-30025	4	SOL4211-100-15	128	SOL4652-155-210	129
57630-92E00		65720-94403		09204-03003		58100-96460-019		58500-98L00	
REC57630-92E00	113	REC65720-94403	10	REC91490-30025	5	SOL4211-101-13	128	SOL4652-155-225	129
57630-92E00		65720-94403		09204-03003		58100-96440-019		58500-98L10	
REC57630-92E00	125	REC65720-94411	10	REC91490-30025	6	SOL4211-103-12	128	SOL4652-155-240	129
57630-92E00		65720-94411		09204-03003		58100-96430-019		58500-98L20	
REC57630-94300	101	REC65720-98520	10	REC91490-30025	89	SOL4211-105-11	128	SOL4652-155-255	129
57630-94300		65720-98520/1/2		09204-03003		58100-96420-019		58500-98L30	
REC57630-94300	103	65720-98511	10	REC91490-30025	9	SOL4211-110-09	128	SOL4652-155-255	129
57630-94300		REC65720-986L0	10	09204-03003		58100-96410-019		58500-98L30	
REC57630-94300	125	65720-986L0	10	REC91490-30025	97	SOL4311-110-15	128	SOL4653-141-180	129
57630-94300		65720-986A0		09204-03003		58100-95363-019		58600-98L31	
REC57630-94500	104	65720-986B0	10	REC91490-30025	99	SOL4311-116-12	128	SOL4653-141-195	129
57630-94500		REC65740-95D01	10	09204-03003		58100-95393-019		58600-98L61	
REC57630-94500	125	65740-95D00	10	REC925093	99	SOL4311-116-13	128	SOL4653-141-210	129
57630-94500		REC65740-99100	10	09280-75002		58100-94313-019		58600-98L01	
REC57630-96300	125	65740-99100	10	REC93101-22067	83	SOL4311-116-14	128	SOL4653-141-225	129
57630-96300		REC65750-87J11	10	09282-22004/7		58100-94313-019		58600-98L11	
REC57630-96300	99	65750-87J11	10	REC93606-12019	107	SOL4311-116-14	128	SOL4653-141-240	129
57630-96300		REC65750-87J11	10	09202-06031		58100-95353-019		58600-98L21	
REC57631-93901	120	65750-87J11	10	REC93606-12019	109	SOL4311-118-11	128	SOL4653-141-255	129
57631-93901		REC65750-94404	10	09202-06031		58100-95222-019		58600-98L31	
REC57631-93901	93	65750-94404/2/1	10	REC93606-12019	111	SOL4311-121-10	128	SOL9311-110-15	130
57631-93901		REC65750-94404	10	09202-06031		58100-95202-019		SOL9311-111-13	130
REC57631-93901	95	65750-98506	10	REC93606-12019	113	SOL4311-121-09	128	SOL9311-111-14	130
57631-93901		REC65750-98505	10	09202-06031		58100-94302-019		SOL9311-114-12	130
REC57631-93901	101	65750-98506	10	REC93606-12019	115	SOL4411-130-19	128	SOL9311-116-11	130
57631-93901		REC65750-98506	10	93606-12019		58100-94522-019		SOL9311-120-10	130
REC57631-95303	103	REC651-24563-00	11	93606-12019	115	SOL4411-130-21	128	SOL9311-121-09	130
57631-95303		15412-93J00		REC95380-06700	101	SOL4411-130-21	128	SOL9311-120-10	130
REC57631-95303	120	REC663-48344-00	34	29141-93J00	103	SOL4411-133-17	128	SOL9311-121-09	130
57631-95303		REC67200-88L00	32	REC95380-06700	103	58100-94512-019		SOL9311-111-13	130
REC57631-95303	120	67200-88L00	32	29141-93J00	89	SOL4411-135-15	128	SOL9311-111-14	130
57631-95303/2/3		67200-93J12/13		REC95380-06700	91	SOL4411-135-15	128	SOL9311-111-14	130
REC57631-96301	120	67200-93J12/13	32	29141-93J00	89	SOL4411-138-13	128	SOL9311-111-14	130
57631-96301		REC67200-88L10	32	REC95380-06700	91	SOL4411-140-11	128	SOL9311-111-13	130
REC57631-96301	99	67200-88L10	32	29141-93J00	93	SOL4413-125-19	128	SOL9311-114-12	130
57631-96301		67200-93J15		REC95380-06700	93	SOL4413-125-21	128	SOL9311-116-11	130
REC57632-93L01	111	REC67200-93J30	33	29141-93J00	93	SOL4413-128-17	128	SOL9311-116-11	130
57632-93L01		67200-93J50/51		REC95380-06700	97	SOL4413-130-15	128	SOL9311-116-11	130
REC57632-93L01	126	67200-93J00/1/2/3/4/6	33	29141-93J00	97	SOL4413-130-15	128	SOL9311-120-10	130
57632-93L01		REC67200-94J20	33	REC95999-03249	24	SOL4413-133-13	128	SOL9311-121-09	130
REC57632-93L01	126	67200-91J00/01/04	33	31100-95240/2/3	50	SOL4413-133-13	128	SOL9311-121-09	130
57632-93L01/1		REC67200-99E56	33	REC67200-99E56	50	SOL4413-135-15	128	SOL9311-121-09	130
REC57632-93L11	120	67200-99E10/30-0EP	33	67200-99E10/30-0EP	50	SOL4413-135-15	128	SOL9311-121-09	130
57632-93L11		67200-99E50/51/56		REC676-11325-00	48	SOL4413-135-15	128	SOL9311-121-09	130
REC57632-93L11	126	REC676-11325-00	48	11281-94400	48	SOL4413-135-15	128	SOL9311-121-09	130
57632-93L11		REC676-11325-00AL	48	11281-94400	48	SOL4413-135-15	128	SOL9311-121-09	130
REC57632-94J00	120	REC67F-12411-01	38	REC67F-12411-01	38	SOL4413-135-15	128	SOL9311-121-09	130
57632-94J00		17670-93J00		REC67F-12411-01	67	SOL4413-135-15	128	SOL9311-121-09	130
REC57632-94J00	126	REC67F-12411-01	67	17670-93J00	67	SOL4413-135-15	128	SOL9311-121-09	130
57632-94J00		REC681-11325-00AL	4	REC681-11325-00AL	4	SOL4413-135-15	128	SOL9311-121-09	130
REC57632-94J00	91	REC681-24251-00	4	REC681-24251-00	4	SOL4413-135-15	128	SOL9311-121-09	130
57632-94J00		REC692-24410-00	12	15100-94301/03/10/11	12	SOL4413-135-15	128	SOL9311-121-09	130
REC57632-94J00	93	15100-94301/03/10/11	12	REC691-24501-10	11	SOL4413-135-15	128	SOL9311-121-09	130
57632-94J00		REC691-24501-10	11	15643-93J00		SOL4413-135-15	128	SOL9311-121-09	130
REC57632-94J00	95	REC68L-11325-00	47	55321-99E00		SOL4413-135-15	128	SOL9311-121-09	130
57632-94J00		REC68L-11325-00AL	47	REC68L-11325-00AL	47	SOL4413-135-15	128	SOL9311-121-09	130
REC57632-97L00	89	55321-99E00	47	55321-99E00	47	SOL4413-135-15	128	SOL9311-121-09	130
57632-97L00		REC68L-11325-00AL	54	REC68L-11325-00AL	54	SOL4413-135-15	128	SOL9311-121-09	130
REC57632-97L00	91	55321-99E00	47	55321-99E00	47	SOL4413-135-15	128	SOL9311-121-09	130
57632-97L00		REC681-45251-00	47	41810-87D00		SOL4413-135-15	128	SOL9311-121-09	130
REC57632-97L00	93	41810-87D00	47	REC6E5-45251-00AL	47	SOL4413-135-15	128	SOL9311-121-09	130
57632-97L00		REC6E5-45251-00AL	47	41810-87D00		SOL4413-135-15	128	SOL9311-121-09	130
REC57632-97L00	95	REC6E5-8195A-01	31	REC6E5-8195A-01	31	SOL4413-135-15	128	SOL9311-121-09	130
57632-97L00		38410-94550/51/52		38410-94550/51/52		SOL4413-135-15	128	SOL9311-121-09	130
REC57633-90J02	109	REC6G5-43864-00	29	REC6G5-43864-00	29	SOL4413-135-15	128	SOL9311-121-09	130
57633-90J02		REC6P3-24564-00	11	15415-93J10		SOL4413-135-15	128	SOL9311-121	

OEM --> REF

08110-60020	121	09141-12005	95	09168-12017	55	09263-20104	122	09280-69001	107
REC08110-60020		REC09141-12005		REC09168-12017		REC09263-20104		REC09280-69001	
08110-60020	91	09141-18005	101	09202-04002	101	09263-20104	93	09280-69001	109
REC08110-60020		REC90171-18M04		REC09202-04002		REC09263-20104		REC09280-69001	
08110-60020	93	09141-18005	103	09202-04002	120	09263-20104	95	09280-69001	115
REC08110-60020		REC90171-18M04		REC09202-04002		REC09263-20104		REC09280-69001	
08110-60020	95	09141-18005	104	09202-04002	126	09263-22020	101	09280-75001	101
REC08110-60020		REC90171-18M04		REC09202-04002		REC09263-22020		REC09280-75001	
08110-60050	122	09141-18005	105	09202-05021	120	09263-22020	103	09280-75001	103
REC08110-60050		REC90171-18M04		REC09202-05021		REC09263-22020		REC09280-75001	
08110-60050	91	09141-18005	107	09202-05021	97	09263-22020	122	09280-75001	119
REC08110-60050		REC90171-18M04		REC09202-05021		REC09263-22020		REC09280-75001	
08110-60050	93	09141-18005	109	09202-05021	99	09263-22035	101	09280-75001	97
REC08110-60050		REC90171-18M04		REC09202-05021		REC09263-22103		REC09280-75001	
08110-60050	95	09141-18005	111	09202-05022	103	09263-22039	103	09280-75002	99
REC08110-60050		REC90171-18M04		REC09202-05022		REC09263-22103		REC925093	
08113-60060	122	09141-18005	126	09202-05022	120	09263-22039	121	09280-92004	105
REC08113-60060		REC90171-18M04		REC09202-05022		REC09263-22103		REC09280-92004	
08113-60060	97	09159-08046	97	09202-06031	107	09263-22103	121	09280-92004	119
REC08113-60060		REC90179-08M06		REC09202-06031		REC09263-22103		REC09280-92004	
08113-60060	99	09159-08046	99	09202-06031	109	09263-24018	81	09280-97001	107
REC08113-60060		REC90179-08M06		REC09202-06031		REC09263-24018		REC09280-97001	
08113-60087	105	09159-22003/4/6	37	09202-06031	111	09263-25025	101	09280-97001	109
REC08113-60087		PAR15-0101707		REC09202-06031		REC09263-25025		REC09280-97001	
08204-03003	107	09160-06082	89	09202-06031	113	09263-25025/48	121	09282-08005	111
REC091490-30025		PAGB/I848-6		REC09202-06031		REC09263-25025		REC09282-08005	
08211-20263	103	09160-06082	95	09202-08006	107	09263-25062	101	09282-10008	82
REC08211-20263		PAGB/I848-6		PAR25-00000014		REC09263-25062		REC09282-10008	
09100-06130	107	09160-06082	97	09202-08006	109	09263-25062	121	09282-10008	89
PAGB/I5783-M6X12		PAGB/I848-6		PAR25-00000014		REC09263-25062		REC09282-10008	
09100-06130	109	09160-12066	95	09202-08006	111	09263-25067	105	09282-12008	82
PAGB/I5783-M6X12		REC09160-12066		PAR25-00000014		REC09263-25067		REC09282-12008	
09103-06281	52	09160-18028	109	09202-08006	113	09263-25067	112	09282-12010	54
PAGB/I5783-M6X14		REC09160-18028		PAR25-00000014		REC09263-25067		REC09282-12010	
09103-06281	89	09160-18028	127	09202-08006	115	09263-25067	122	09282-12010	82
PAGB/I5783-M6X14		REC09160-18028		PAR25-00000014		REC09263-25067		REC09282-12010	
09116-06094	101	09160-20027	91	09204-02001	126	09263-25102	121	09282-12104	55
REC09116-06094		REC09160-20027		PAGB/I91-1.6X12		REC09263-25025		REC09282-12010	
09116-06094	111	09160-20027	95	09204-02004	126	09263-26008	122	09282-15008	82
REC09116-06094		REC09160-20027		REC09204-02004		REC09263-26023		REC09282-15008	
09116-06094	115	09160-20041	93	09204-02004	91	09263-26023	104	09282-15010	115
PAGB/I5783-M6X16		REC09160-20041		REC09204-02004		REC09263-26023		REC09282-15010	
09116-06094	118	09160-20041	95	09204-02004	95	09263-26023	105	09282-17005	101
REC09116-06094		REC09160-20041		REC09204-02004		REC09263-26023		REC09282-17005	
09116-06094	52	09160-20042	91	09204-03003	101	09263-26023	122	09282-17005	83
REC09116-06094		REC09160-20042		REC091490-30025		REC09263-26023		REC09282-17005	
09116-06094	93	09160-20042	93	09204-03003	103	09263-27005	78	09282-17005	103
REC09116-06094		REC09160-20042		REC091490-30025		REC09263-27005		REC09282-17005	
09116-06094	97	09160-20042	95	09204-03003	104	09263-27005	81	09282-17006	82
REC09116-06094		REC09160-20042		REC091490-30025		REC09263-27005		REC09282-17006	
09116-06106	99	09160-20043	91	09204-03003	105	09265-17002	121	09282-17006	97
PAGB/I5787-M6X20		REC09160-20043		REC091490-30025		REC09265-17002		REC09282-17006	
09116-06121	118	09160-20043	93	09204-03003	111	09265-17002	97	09282-17007	101
REC09116-06121		REC09160-20043		REC091490-30025		REC09265-17002		REC09282-17007	
09116-06121	52	09160-20043	95	09204-03003	113	09265-17002	99	09282-17007	44
REC09116-06121		REC09160-20043		REC091490-30025		REC09265-17002		REC09282-17007	
09116-06121	97	09160-20044	91	09204-03003	126	09269-30012	78	09282-17009	83
REC09116-06121		REC09160-20044		REC091490-30025		REC09269-30012		REC09282-17009	
09116-06121	99	09160-20044	93	09204-03003	89	09269-30012	80	09282-17009	59
REC09116-06121		REC09160-20044		REC091490-30025		REC09269-30012		REC09282-17009	
09116-06225	104	09160-20044	95	09204-03003	97	09269-32001/2	121	09282-22004/7	83
PAGB/I5783-M6X16		REC09160-20044		REC091490-30025		REC09269-32002		REC93101-22067	
09116-06225	115	09160-20052	81	09204-03003	81	09269-32002	111	09282-24003	61
PAGB/I5783-M6X16		REC09160-20052		REC091490-30025		REC09269-32002		REC09282-24003	
09116-06225	89	09160-21009	91	09209-08016	119	09269-32002	112	09282-24003	62
PAGB/I5783-M6X16		REC09160-21009		REC09209-08016		REC09269-32002		REC09282-24003	
09116-06225	89	09160-21009	93	09209-08016	97	09269-32002	113	09282-24003	63
PAGB/I5783-M6X16		REC09160-21009		REC09209-08016		REC09269-32002		REC09282-24003	
09116-06227	91	09160-21009	95	09209-08016	99	09280-00030	119	09282-24003	75
PAGB/I5787-M6X20		REC09160-21009		REC09209-08016		REC09280-00050		REC09282-24003	
09116-06227	95	09160-26015	101	09240-03003	109	09280-00040	111	09282-24003	75
PAGB/I5787-M6X20		REC09160-26015		REC091490-30025		REC09280-00040		REC09282-24003	
09116-06229	89	09160-27008	78	09248-10008	101	09280-00047	113	09282-24004	107
PAGB/I5283-M6X25		REC09160-27008		REC09248-10008		REC09280-00047		REC09282-24008	
09116-06229	91	09160-27008	81	09248-10008	103	09280-00047	115	09282-24004	109
REC09116-06229		REC09160-27008		REC09248-10008		REC09280-00047		REC09282-24008	
09116-08114	115	09162-06006	99	09248-10008	104	09280-00050	113	09282-24004	111
PARF-00000003		PAGB/I848-6		REC09248-10008		REC09280-00050		REC09282-24008	
09116-08117	93	09168-10022	101	09248-10008	105	09280-08005	117	09282-24004	113
PAGB/I5783-M8X55		REC09168-10022		REC09248-10008		REC09280-08005		REC09282-24008	
09116-08122	97	09168-10022	103	09248-10008	107	09280-13005	39	09282-24008	115
PAGB/I5787-M6X30		REC09168-10022		REC09248-10008		REC09280-13005		REC09282-24008	
09116-08131	109	09168-10022	104	09248-10008	109	09280-13005	61	09282-25001	105
REC09116-08131		REC09168-10022		REC09248-10008		REC09280-13005		REC09282-25001	
09116-08131	111	09168-10022	107	09248-10008	117	09280-21015	115	09282-25001	119
REC09116-08131		REC09168-10022		REC09248-10008		REC09280-21015		REC09282-25001	
09116-08131	113	09168-10022	109	09248-10008	89	09280-22019	52	09282-28002	107
REC09116-08131		REC09168-10022		REC09248-10008		REC09280-22019		REC09282-28002	
09116-08131	118	09168-10022	117	09248-10008	93	09280-22019	55	09282-30006	111
REC09116-08131		REC09168-10022		REC09248-10008		REC09280-22019		REC09282-30006	
09116-08151	91	09168-10022BULK		09248-10008	97	09280-22019	56	09282-30006	113
PAGB/I5783-M8X30		REC09168-10022BULK		REC09248-10008		REC09280-22019		REC09282-30006	
09116-08151	95	09168-10022	89	09248-10008	99	09280-22019	63	09282-30007	109
PAGB/I5783-M8X30		REC09168-10022		REC09248-10008		REC09280-22019		REC09282-30007	
09116-08156	89	09168-10022	93	09262-25003	95	09280-22019	58	09282-30007	107
PAGB/I5787-1986		REC09168-10022		REC09262-25078		REC09280-22019		REC09282-	

09283-32048	57	09420-04006	99	1141-93950	79	11189-96100	65	11489-90100	74
REC09283-32048		REC09420-04006		REC1141-93960		REC11189-96100		REC11489-90100	
09283-32048	75	09420-04009	41	1141-93950	79	11189-96100	73	11489-93E11	54
REC09283-32048		REC09420-04009		REC1141-93960		REC11189-96100		REC11489-93E11	
09283-32048	75	09420-05005	41	1141-93E20	69	11219-95J01	57	11489-93E11	70
REC09283-32048		REC09420-05005		REC1141-93E20		REC11219-95J01		REC11489-93E11	
09283-34014	57	09420-05009	41	1141-93J03	70	11219-95J01	73	11489-93J01	74
REC09283-34014		REC09420-05009		REC1141-93J10		REC11219-95J01		REC11489-93E11	
09283-34014	75	09420-05009	107	1141-93J10	67	11261-93J00	48	11489-93J00	67
REC09283-34014		REC09420-05009		REC1141-93J10		REC11261-93J00		REC11489-93J00	
09283-34014	75	09420-05009	109	1141-94440	79	11261-93J00	55	11489-93J00	74
REC09283-34014		REC09420-05009		REC1141-94450		REC11261-93J00		REC11489-93J00	
09283-35043	78	09420-05009	111	1141-94450	79	11261-93J00	56	11489-95J01	57
REC09283-35043		REC09420-05009		REC1141-94450		REC11261-93J00		REC11489-95J01	
09283-35043	83	09420-05009	112	1141-94506/20	79	11261-93J00	57	11489-95J01	70
REC09283-35043		REC09420-05009		REC1141-94506		REC11261-93J00		REC11489-95J01	
09283-35047	75	09420-05009	113	1141-94620	79	11261-93J00	58	11489-96J01	65
REC12281-87J00		REC09420-05009		REC1141-94506		REC11261-93J00		REC11489-96J01	
09283-37005	59	09420-05009	115	1141-94720	79	11261-93J00	59	11489-96J01	74
REC09283-37005		REC09420-05009		REC1141-94720		REC11261-93J00		REC11489-96J01	
09283-37005	75	09440-05027	93	1141-94720	79	11261-93J00	60	11489-98L00	68
REC12281-87J00		REC09440-05027		REC1141-94720		REC11261-93J00		REC11489-98L00	
09283-38025	75	09440-08043	103	1141-94J00	69	11261-93J00	61	11489-98L00	74
REC09283-38025		REC09440-08043		REC1141-94J00		REC11261-93J00		REC11489-98L00	
09283-38025	75	09440-32008	93	1141-94J10	54	11261-93J00	62	11542-87L00	60
REC09283-38025		REC09440-32008		REC1141-94J10		REC11261-93J00		REC11542-87L00	
09283-52004	61	09440-40002	101	1141-94J10	69	11261-93J00	63	11542-87L00	84
REC09283-52004		REC09440-40002		REC1141-94J10		REC11261-93J00		REC11542-87L00	
09283-52004	75	09440-40002	103	1141-94L00	56	11261-93J00	65	11552-87L00	44
REC09283-52004		REC09440-40002		REC1141-94L00		REC11261-93J00		REC11552-87L00	
09283-52006	62	09482-00642	68	1141-94L00	69	11261-93J00	67	11552-88L00	44
REC09283-52006		NGK12KR7D8		REC1141-94L00		REC11261-93J00		REC11552-88L00	
09283-52006	63	09482-00299	23	1141-95505	79	11261-93J00	68	11552-88L00	59
REC09283-52006		NGKBP6E5		REC1141-95505		REC11261-93J00		REC11552-88L00	
09283-52006	75	09482-00299	23	1141-95621	79	11265-87E00/H17	52	11552-96J00	44
REC09283-52006		NGKBP6E5		REC1141-95505		REC11265-87E10		REC11552-96J00	
09283-91001	65	09482-00406	23	1141-95D40	79	11265-87E10	58	11552-96J00	65
REC09283-91001		NGKCR6H5A		REC1141-95D40		REC11265-87E10		REC11552-96J00	
09283-91001	67	09482-00427	23	1141-95D40	79	11265-87E10	61	12110-93130	81
REC09283-91001		NGKCKR6E		REC1141-95D40		REC11265-87E10		REC12110-93130K	
09283-91001	68	09482-00427	23	1141-95J00	57	11265-87E10	62	12110-94350	78
REC09283-91001		NGKCKR6E		REC1141-95J00		REC11265-87E10		REC12110-94350K	
09283-91001	75	09482-00427	23	1141-95J00	69	11265-87E10	63	12110-94400K	81
REC09283-91001		NGKCKR6E		REC1141-95J00		REC11265-87E10		REC12110-94400K	
09283-91001	75	09482-00427	23	1141-96343	79	11272-93J00	67	12110-94400K	81
REC09283-91001		NGKCKR6E		REC1141-96344		REC11272-93J00		REC12110-94400K	
09289-05006/12	76	09482-00427	57	1141-96344	79	11272-93J00	73	12140-02C10	54
PAF166-010003		NGKCKR6E		REC1141-96303		REC11272-93J00		REC12140-02C10	
09289-05006	54	09482-00427	61	1141-96344	79	11281-94400	48	12140-02C10	77
PAF166-010003		NGKCKR6E		REC1141-96344		REC676-11325-00		REC12140-02C10	
09289-05006	55	09482-00427	62	1141-96344	79	11281-94400	48	12140-75F30	57
PAF166-010003		NGKCKR6E		REC1141-96303		REC676-11325-00AL		REC12140-75F30	
09289-05006	57	09482-00427	65	1141-96J00	65	11318-96J00	65	12140-75F30	77
PAF166-010003		NGKCKR6E		REC1141-96J01		REC11318-96J00		REC12140-75F30	
09289-05006	59	09482-00427	67	1141-96J01	69	11318-96J00	72	12140-86FA0	61
PAF166-010003		NGKCKR6E		REC1141-96J01		REC11318-96J00		REC12140-86FA0	
09289-05006	65	09482-00446	23	1141-96L00	65	11332-93J00	67	12140-86FA0	77
PAF166-010003		NGKDCPR6E		REC1141-96L00		REC11332-93J00		REC12140-86FA0	
09289-05006	67	09482-00446	23	1141-96L00	69	11332-93J00	73	12140-87J01	77
PAF166-010003		NGKDCPR6E		REC1141-96L00		REC11332-93J00		REC12140-87J01	
09289-05006	68	09482-00446	23	1141-97J01	69	11332-96J00	65	12140-87L01	77
PAF166-010003		NGKDCPR6E		REC1141-97J02		REC11332-96J00		REC12140-87L01	
09289-05006	56	09482-00446	56	1141-97J10	69	11332-96J00	73	12140-88L01	59
REC09289-05008		NGKDCPR6E		REC1141-97J02		REC11332-96J00		REC12140-88L01	
09289-05008	76	09482-00446	58	1141-98130	79	11333-98L00	68	12140-88L01	71
REC09289-05008		NGKDCPR6E		REC1141-98130		REC11333-98L00		REC12140-88L01	
09289-05104	76	09482-00446	59	1141-98130	79	11333-98L00	73	12140-89L00	56
PAF166-010003		NGKDCPR6E		REC1141-98130		REC11333-98L00		REC12140-89L00	
09289-06003	61	09482-00446	60	1141-98130	79	11342-96J00	65	12140-89L00	77
REC09289-06003		NGKDCPR6E		REC1141-98130		REC11342-96J00		REC12140-89L00	
09289-06003	62	09482-00528	23	1141-98401	79	11342-96J00	73	12140-89L10	55
REC09289-06003		REC11410-87851		REC1141-98401		REC11342-96J00		REC12140-89L10	
09289-06003	63	09482-00642	23	1141-98411	79	11351-95J01	57	12140-89L10	56
REC09289-06003		NGKCR6E		REC1141-98401		REC11351-95J01		REC12140-89L10	
09289-06003	76	09482-00642	23	1141-98J00	70	11351-95J01	74	12140-89L10	77
REC09289-06003		NGKCR6E		REC1141-98J00		REC11351-95J01		REC12140-89L10	
09289-10002	89	09482-00649	23	1141-98J10	67	11400-87800/1/2/3/4	71	12140-89L20	77
REC09289-10002		NGKCKR6E		REC1141-98J10		REC11400-87804		REC12140-89L20	
09289-10005	82	09482-00649	63	1141-98L00	68	11400-88870/1/2	71	12140-91J10	77
REC09289-10005		NGKCKR6E		REC1141-98L00		REC11400-88872		REC12140-91J10	
09289-12002	82	09482-00661	23	1141-98L00	70	11400-92860/1/2/3	71	12140-92J10	62
REC09289-12002		NGKMR6K-9		REC1141-98L00		REC11400-92863		REC12140-92J10	
09289-12003	82	09482-00661	23	1141-99L00	63	11400-96869	71	12140-92J10	63
REC09289-12003		NGKMR6K-9		REC1141-99L00		REC11400-96883		REC12140-92J10	
09289-12003	93	09482-00L04	23	1141-99L00	69	11400-96880/1/2/3	71	12140-92J10	77
REC09289-12003		NGKCP6E-9		REC1141-99L00		REC11400-96883		REC12140-92J10	
09289-17004	83	09482-00L04	23	1142-93J03	70	11400-96892/93	71	12140-93121	81
REC16-161622		NGKCP6E-9		REC1142-93J10		REC11400-96893		REC12140-93121	
09289-17006	93	09482-00L04	54	1142-93J10	67	11410-97901/1	71	12140-93121	81
REC09289-17006		NGKCP6E-9		REC1142-93J10		REC11410-97851		REC12140-93121	
09289-17102	91	09482-00L04	55	1142-98J00	70	11410-90820/1/2/3	71	12140-93J00	67
REC09289-17006		NGKCP6E-9		REC1142-98J10		REC11410-90823		REC12140-93J00	
09289-17102	95	11130-94600	51	1142-98J10	67	11410-93832/3/5	71	12140-93J00	77
REC09289-17006		CM1130-94600		REC1142-98J10		REC11410-93835		REC12140-93J00	
09289-20009	82	PAGB/15783-M6X14	51	1142-98L00	71	11410-93870/71/72	71	12140-94400	78
REC09289-20009		11130-94600		REC1142-98L00		REC11410-93872		REC12140-94400	
09289-20009	97	11130-94600A	51	1142-98L00	70	11410-94820/1/3/6/7	71	12140-94400	81
REC09289-20009		CM1130-94600A		REC1142-98L00		REC11410-94826			

12412-98L00	68	13640-32G20	20	15412-92J00	11	17400-92J21	107	17413-95J00	45
REC12472-98L00		REC13640-32G20		REC15412-92J00		REC17400-92J21		REC17413-95J00	
12710-97J00	74	13650-52G00	19	15412-93J00	11	17400-92J21	109	17413-95J00	97
REC12710-97J00		REC13650-52G00		REC15412-93J00		REC17400-92J21		REC17413-95J00	
12730-96J00/1	75	13650-56B00	19	15412-93J10	11	17400-92J21	43	17413-96J00/1	45
REC12730-96J01		REC13650-56B00		REC15412-93J10		REC17400-92J21		REC17413-96J01	
12761-72F00	77	1385-95200/10	86	15412-93J10	11	17400-9391/12	43	17413-96J01	111
REC12761-72F00		REC1385-95210		REC15412-93J10		REC17400-93912		REC17413-96J01	
12761-93E10	54	13910-87D00	17	15413-87D10	11	17400-93950	43	17413-97J00	45
REC12761-93E10		REC13910-87D00		15415-93J10	11	REC17400-93951		REC17413-97J00	
12761-93E10	55	13910-89J01	17	REC15413-87D10	12	17400-93951	93	17413-99E10	104
REC12761-93E10		REC13910-89J01		15440-87L10	12	REC17400-93951		REC17413-99E11	
12761-93E10	77	13910-94400	17	REC15440-87L10	12	17400-93J00/01	42	17413-99E10	105
REC12761-93E10		REC13910-94400		15440-90J00	12	REC17410-93J01		REC17413-99E11	
12761-94L00/10	77	13910-94701	17	REC15440-90J00	12	17400-93J00/1/2/3	44	17413-99E11	45
REC12761-94L10		REC13910-94701		15440-93J00	12	REC17400-93J01		REC17413-99E11	
12761-94L10	56	14141-93952-0EP	85	REC15440-93J00	12	17400-93J01	112	17416-92J00	107
REC12761-94L10		REC14141-93952-0EP		15440-96J00	12	REC17400-93J01		REC17416-92J00	
12761-99J00	77	14151-87L00	84	15440-96J01	12	17400-94611	43	17416-92J01	107
REC12761-99J00		REC14151-87L00		15440-96J01	12	REC17400-94611		REC17416-92J01	
12778-93J00	72	14151-88L00	59	15440-96J01	12	17400-94700/1	43	17416-92J10	107
REC12778-93J00		REC14151-88L00		15440-99E00/1	12	REC17400-94701		REC17416-92J10	
12911-86FA2	61	14151-88L00	84	15440-99E01	12	17400-94J200	43	17416-92J10	109
REC12911-86FA2		REC14151-88L00		15626-88L00/01	14	REC17400-94J00		REC17416-92J10	
12911-86FA2	62	14151-90J00	61	REC15626-88L01	14	17400-94L00	43	17416-92J10	44
REC12911-86FA2		REC14151-90J00		15626-90J00	14	REC17400-94L00		REC17416-92J10	
12911-86FA2	63	14151-90J00	62	REC15626-90J00	14	17400-95350/1	43	17416-93J00	112
REC12911-86FA2		REC14151-90J00		15626-92J01/01	14	REC17400-95351		REC17416-93J00	
12911-86FA2	76	14151-90J00	63	15626-93J00	14	17400-95550	43	17416-93J00	113
REC12911-86FA2		REC14151-90J00		15626-93J00	14	REC17400-95551		REC17416-93J00	
12911-88L00	59	14151-90J00	84	15626-99E00	14	17400-95J01/2	43	17416-93J00	115
REC12911-88L00		REC14151-90J00		REC15626-99E00	14	REC17400-95J02		REC17416-93J00	
12911-88L00	76	14151-93901	85	15626-99E00	14	17400-95J02	97	17416-93J00	44
REC12911-88L00		REC14151-93912		REC15626-99E00	14	REC17400-95J02		REC17416-93J00	
12911-93J00	65	14151-93J00	67	15642-88L00	12	17400-96350/1/2/3	43	17416-95J00	103
REC12911-93J00		REC14151-93J00		REC15642-88L00	12	REC17400-96403		REC17416-95J00	
12911-93J00	67	14151-93J00	84	REC15642-88L00	12	17400-96352	99	17416-95J00	44
REC12911-93J00		REC14151-93J00		REC15642-90J00	12	REC17400-96403		REC17416-95J00	
12911-93J00	76	14151-94412	85	15643-93J00	11	17400-96403	101	17416-95J00	97
REC12911-93J00		REC14151-94411		REC15643-93J00	11	REC17400-96403		REC17416-95J00	
12911-98J00	67	14151-96310	85	REC15643-99E00	14	17400-96403	43	17416-96J00	111
REC12911-98J00		REC14151-96311		15647-93J00	16	17400-96403	44	17416-96J00	44
12911-98J00	76	14151-96J00	65	REC15647-93J00	16	17400-96J03	111	17416-96J00	105
REC12911-98J00		REC14151-96J00		15710-50M00	15	REC17400-96J03		REC17416-96J00	
12911-98L00	68	14151-96J00	84	REC15710-50M00	15	17400-96J03	111	17416-99E10	105
REC12911-98L00		REC14151-96J00		15710-89L00	15	REC17400-96J03		REC17416-99E10	
12911-98L00	76	14152-93J00	67	REC15710-89L00	15	17400-98551	43	17416-99E10	44
REC12911-98L00		REC14152-93J00		15710-65D00	15	REC17400-98551		REC17416-99E10	
12915-73G20	59	14212-91L00	85	REC15710-65D00	15	17400-98652/61	43	17417-92J00	107
REC12915-73G20		REC14212-91L00		15710-66D00	15	REC17400-98652		REC17417-92J00	
12915-73G20	76	14212-93J00	67	REC15710-66D00	15	17400-98661	43	17417-92J00	44
REC12915-73G20		REC14212-93J00		15710-82K50	15	REC17400-98661		REC17417-92J00	
12915-86FA1	61	14212-93J00	84	REC15710-82K50	15	17400-98661	89	17431-92L20	118
REC12915-86FA1		REC14212-93J00		15710-82M00	15	REC17400-98661		REC17431-92L20	
12915-86FA1	62	14212-94412	85	REC15710-82M00	15	17400-986L0/1	43	17431-94440/1	118
REC12915-86FA1		REC14212-94413		15710-85K00	15	REC17400-98661		REC17431-92L20	
12915-86FA1	63	14212-96310	85	REC15710-85K00	15	17400-98J00/1/2	44	17450-93440	42
REC12915-86FA1		REC14212-91L00		15710-87J00	15	REC17400-98J01		REC17450-93921	
12915-86FA1	76	14212-98L00	84	REC15710-87J00	15	17400-98J01	113	17450-93920/21/30	42
REC12915-86FA1		REC14212-98L00		15710-87L00	15	REC17400-98J01		REC17450-93921	
12915-93J60	65	15100-72811/12	14	REC15710-87L00	15	17400-98L03	115	17450-93921	93
REC12915-93J60		REC15100-72812		15710-89L00	15	REC17400-98L03		REC17450-93921	
12915-93J60	67	15100-7281V	14	REC15710-89L00	15	17400-98L03	44	17451-96301	40
REC12915-93J60		REC15100-7281V		15710-93J00	15	REC17400-98L03		REC17461-96312	
12915-93J60	76	15100-87J01/02/03	13	REC15710-93J00	15	17400-99J00/01	43	17452-93910	45
REC12915-93J60		REC15100-87J03		15710-99E00	15	REC17400-99J01		REC17452-93910	
12915-93J60	76	15100-87J03	13	REC15710-99E00	15	17400-99J01	95	17452-93910	93
REC12915-93J60		REC15100-89L10/11/21		15751-94900	15	REC17400-99J01		REC17452-93910	
12915-98L00	68	15100-89L10/11/21	12	REC15751-94900	15	17400-99J01	95	17453-93900/01	118
REC12915-98L00		REC15100-89L21		16433-93J00	67	REC17400-99J01		REC17453-93900	
12915-98L00	76	15100-90900	12	REC16433-93J00	72	17410-88L00	103	17453-93900	93
REC12915-98L00		REC15100-93912		16433-93J00	72	REC17410-88L00		REC17453-93900	
13119-90J00	61	15100-90J00/01/10/11	13	REC16433-93J00	72	17410-88L00	42	17461-87E10/11/12	40
REC13119-90J00		REC15100-90J11		16510-05240	17	REC17410-88L00		REC17461-87E12	
13119-90J00	62	15100-90J11	13	REC16510-05240	17	17410-92J00	107	17461-87E10/11/12	40
REC13119-90J00		REC15100-90J11		16510-05240	17	REC17410-92J00		REC17461-87E12-HP	
13119-90J00	63	15100-91J00/01/02	12	16510-05240	17	17410-92J00	42	17461-87E12	104
REC13119-90J00		REC15100-91J02		16510-05240	17	REC17410-92J00		REC17461-87E12	
13119-90J00	86	15100-93910/11/12	12	16510-18H11	17	17410-93J01	112	17461-87E12	105
REC13119-90J00		REC15100-93912		16510-45H10	17	REC17410-93J01		REC17461-87E12	
13119-93J00	67	15100-94301/03/10/11	12	REC16510-45H10	17	17410-93J01	113	17461-87E12	40
REC13119-93J00		REC15100-94300		16510-05240	17	REC17410-93J01		REC17461-87E12	
13119-93J00	86	15100-94900	13	16510-1A101/30/31	17	17410-93J01	115	17461-87E12	40
REC13119-93J00		REC15100-94900		REC16510-90J00	17	REC17410-93J01		REC17461-87E12-HP	
13119-95J00	57	15100-94L00/01	13	16510-61A20-MHL	17	17410-95J00	42	17461-90J00/1	40
REC13119-95J00		REC15100-94L01		REC16510-90J00	17	REC17410-95J00		REC17461-90J01	
13119-98J00	67	15100-95J03/04	12	16510-61A21-MHL	17	17410-95J00	97	17461-90J00/1	40
REC13119-98J00		REC15100-95J04		16510-81420	17	REC17410-95J00		REC17461-90J01-HP	
13119-98J00	86	15100-96J01	13	REC16510-82703	17	17410-95J00	105	17461-90J01	107
REC13119-98J00		REC15100-96J01		16510-82703	17	REC17410-99E10		REC17461-90J01	
13119-98L00	68	15100-96J01	13	REC16510-82703	17	17410-99E10	42	17461-90J01	109
REC13119-98L00		REC15100-96J01		16510-87J00/L0	17	REC17410-99E10		REC17461-90J01	
13119-98L00	86	15100-98J00	13	REC16510-87J00	17	17411-90J00	42	17461-90J01	111
REC13119-98L00		REC15100-98J00		16510-87J01	57	REC17400-90812		REC17461-90J01	
13122-95J00	57	15100-99E11	13	REC16510-87J01	57	17411-93901/10	42	17461-90J01	40
REC13122-95J00		REC15100-99E11		16510-90J00	17	REC17411-93901		REC17461-90J01	
13122-95J00	86	15170-91J00	14	REC16510-90J00	17	17411-93901	93	17461-90J01	40
REC13122-95J00		REC15170-91J00		16510-92J00	17	REC17411-93901		REC17461-90J01-HP	
13125-95200/10	16	15170-93920	14	REC16510-92J00	17	17411-93J00	42	17461-92D02	40
REC13125-95210		REC15170-93911		16510-96J00/10	17	REC17410-93J01		REC17461-92D02	
13125-95J00	16	15170-94320	14	REC16510-96J11	17	17411-94421	101	17461-92D02	40
REC13125-95J00		REC15170-94320		16510-96J11	68	REC17411-94421		REC17461-92D02-HP	
13125-95J00	57	15170-94J00	14	REC16510-93J00	68	17411-94421/31	42	17461-92D02	40
REC13125-95J00		REC15170-94J00		16510-96J11	68	REC17411-94421		REC17461-92D02	
13147-98J00	84	15170-98L10	14						

17461-94510	40	17472-87E10	45	18117-84380	19	31100-95D00	23	37100-87J00-OEP	27
REC17461-90J01-HP		REC17472-87E10		REC8778051		REC50-8M0147039		REC38100-87J00	
17461-94700/1	40	17472-87L00	105	18137-52D00	19	31100-95J00/01	23	37100-9614/15	35
REC17461-94700		REC17472-87L00		REC18137-52D00		31100-96310/11	23	REC37100-9615	
17461-94700/1	40	17472-87L00	45	18137-77E00	19	REC50-8M0147039		37100-96J20/21/22/23/24/25	35
REC17461-94700-HP		REC17472-87L00		REC18137-77E00		31100-96J00/1	24	REC37100-96J25	
17461-94701	40	17472-87L00	60	18137-77E00	61	31100-96J02	24	37100-9310/11	35
REC17461-94700		REC17472-87L00		REC18137-77E00		31100-96J02	24	REC37100-9311	
17461-94701	40	17472-91J00	45	18137-77E00	62	31100-98J02	24	37110-99E00	35
REC17461-94700-HP		REC17472-91J00		REC18137-77E00		31100-98L10	24	REC37110-99E00	
17461-94L00	40	17472-91J00	89	18137-87L01	19	REC31100-98L10		37220-92E00	30
REC17461-96312		REC17472-91J00		REC18137-87L01		31800-94400/1	24	REC37220-92E00	
17461-94L00	40	17472-92D10	45	18137-88L00/01	19	REC89-825096T01		37800-93953/4	35
REC17461-96312-HP		REC17472-92D10		REC18137-88L01		31800-94L01	24	REC37800-93954	
17461-95200	40	17472-93911	45	18137-93J00	19	32140-93900	21	37820-80001/2	20
REC17461-94700		REC17472-93911		REC18137-93J00		REC32140-93900		REC37820-80002	
17461-95200	40	17472-93911	93	18137-93J00	65	32140-94400	21	37820-92E00	35
REC17461-94700-HP		REC17472-93911		REC18137-93J00		REC32140-94400		REC37820-92E03	
17461-95201	40	17472-93J00	111	18213-98J00/10/20/30	20	32140-96310	21	37820-93J00	20
REC17461-94700		REC17472-93J00		REC18213-98J30		32140-96310	21	REC37820-93J00	
17461-95201	40	17472-93J00	112	18590-58M00	19	32800-98100	26	37820-93E10/11	20
REC17461-94700-HP		REC17472-93J00		REC18590-58M00		REC32800-98F10		PAF15-0701000	
17461-95300/1/2	40	17472-93J00	45	18590-68H00	19	32800-87J10	26	37820-93J05	35
REC17461-95300		REC17472-93J00		REC18590-72F21		REC32800-87J10		REC37820-93J05	
17461-95300	40	17472-95310	45	18590-68H00	19	32800-87L00	26	37820-98J00	20
REC17461-95300		REC17472-95310		REC18590-68H00		REC32800-87L00		REC37820-98J00	
17461-95501	40	17472-96301/2/3	45	18590-72F21	19	32800-88L00	26	37820-99E00/1/2	20
REC17461-95300		REC17472-96303		REC18590-72F21		REC32800-88L00		REC37820-99E02	
17461-95501	40	17472-96303	101	18590-72F21	65	32800-89J00	26	37830-89E02	35
REC17461-95300		REC17472-96303		REC18590-72F21		REC32800-89J00		REC37830-89E03	
17461-96301	40	17472-96303	103	18590-80C40	19	32800-89J01/11	26	37830-91J01	35
REC17461-96312		REC17472-96303		REC18590-80C40		REC32800-89J01		REC37830-91J04	
17461-96301	40	17472-96303	97	19137-88L02	59	32800-89L00/01	26	37830-95000	35
REC17461-96312-HP		REC17472-96303		REC18137-88L01		REC32800-89L01		REC37830-89E03	
17461-96301	40	17472-96303	99	23211-94401	120	32800-90J00	26	37830-95D00/1/2/3/4	35
REC17461-96312		REC17472-96303		REC23211-94401		REC32800-90J00		REC37830-95D04	
17461-96301	40	17472-97J00	45	23311-95D10	117	32800-90J00	61	37850-90J00/1/2/3/4/5/6	30
REC17461-96312-HP		REC17472-97J00		REC61N-44146-00		REC32800-90J00		REC37850-90J06	
17461-96301	40	17472-97J10	45	25222-93901	117	32800-90J20	26	37850-93J10	30
REC17461-96312		REC17472-97J10		REC25222-93901		REC32800-90J20		REC37850-93J10	
17461-96301	40	17472-98503	45	25222-96300	117	32800-90J20	61	38100-87D00/01/1/02H	27
REC17461-96312-HP		REC17472-98503		REC25222-96300		REC32800-90J20		REC38100-87E10-OED	
17461-96301	40	17472-98611	45	25700-67L00	116	32800-92E20	26	38100-87D01-OED/02M	27
REC17461-96312		REC17472-98611		REC25700-87L00		REC32800-92E20		REC38100-87E10-OED	
17461-96301	40	17472-98J00	113	25700-88400	116	32800-93J01/2/3	26	38100-87D10-OED/01T	28
REC17461-96312-HP		REC17472-98J00		REC25700-88L00		REC32800-93J03		REC38100-87D10-OED	
17461-96310	40	17472-98J00	45	25700-90J01	116	32800-94610/20	26	38100-87D10-35J	28
REC17461-96312		REC17472-98J00		REC25700-90J01		REC32800-94620		REC38100-87D10-OED	
17461-96310	40	17472-98L00	115	25700-92J00	116	32800-94J00/01	26	38100-87E10-OED	27
REC17461-96312-HP		REC17472-98L00		REC25700-92J00		REC32800-94J01		REC38100-87E10-OED	
17461-96312	101	17472-98L00	45	25700-93J00	116	32800-94J10/11	26	38100-87E20-OED	28
REC17461-96312		REC17472-98L00		REC25700-93J00		REC32800-94J11		REC38100-87D10-OED	
17461-96312	103	17560-91L00	118	25700-93L00	116	32800-95720	26	38100-87J11/20	27
REC17461-96312		REC17560-91L00		REC25700-93L00		REC32800-95D01		REC38100-87J12	
17461-96313	40	17560-96300/1/4	118	25700-94400	116	32800-95D00/01	26	38100-87J0EP	27
REC17461-96312		REC17560-91L00		REC25700-88L00		REC32800-95D01		REC38100-87J00	
17461-96312	40	17563-94400	101	25700-95D00/1	116	32800-98J01	26	38100-87L00/1/2/3	27
REC17461-96312-HP		REC17563-94400		REC25700-95D01		REC32800-98J01		REC38120-2Y8-003	
17461-96312	97	17563-94400	39	25700-95J00	116	32800-99J00	26	38100-87L12/13	28
REC17461-96312		REC17563-94400		REC25700-95J00		REC32800-99J00		REC38100-87L12	
17461-96312	99	17564-93J01	115	25700-98J00	116	32900-93902/3	21	38100-88L00/11/12	27
REC17461-96312		REC17564-93J01		REC25700-98J00		REC32900-93903		REC38120-2W4-HT2	
17461-97110	40	17564-93J01	39	25700-98L01/2/4/5	116	32900-93911	25	38100-90J30/40	27
REC17461-97J10		REC17564-93J01		REC25700-98L04		REC32900-93910		REC38120-2Y3-013	
17461-98501/2/3	40	17565-94400	39	25700-99E00	116	32900-93910	21	38100-92J00-0FD	28
REC17461-98503		REC17565-94400		REC25700-99E00		32900-94401/21/80	21	REC38100-92J01-OED	
17461-98501/2/3	40	17565-94900	101	29116-93J00	115	32900-94460/70	25	38100-91J01/02/10/12	28
REC17461-98503-HP		REC17565-94400		PAGB/15787-M6X20		REC32900-94460		REC38100-96J00	
17461-98503	40	17566-94400	101	29116-93J00	93	32900-96340	21	38100-93J02	28
REC17461-98503		REC17566-94400		PAGB/15787-M6X20		REC32900-96340		REC38100-96J00	
17461-98503	40	17566-94400/1	39	29116-93J10	105	32900-96350	25	38100-93J11/13/30/40	27
REC17461-98503-HP		REC17566-94400		PAF8-00000003		REC32900-96371		REC38120-2Y6-013	
17461-985M0	89	17616-87J00	58	29116-93J10	115	32900-96370/71	25	38100-93J14	27
REC17461-98503		REC17616-87J00		PAF8-00000003		REC32900-96371		REC38120-2Y3-013	
17462-93990	41	17616-87J00	73	29141-93J00	101	33220-50M00	20	38100-96J00/01	28
REC17462-93990		REC17616-87J00		REC95380-06700		REC33220-50M00		REC38100-96J00	
17462-93990	93	17660-90J00	39	29141-93J00	103	33220-58J20	20	38100-97J01-OED	27
REC17462-93990		REC17660-90J00		REC95380-06700		REC33220-58J20		REC38100-97J00-OED	
17471-87D00/01	41	17660-99E00/1	39	29141-93J00	89	33220-64L00	21	38100-98L00/01/02	28
REC17471-87D01		REC17660-99E01		REC95380-06700		REC33220-64L00		REC38100-98L00	
17471-87E00/01	41	17660-99E01	67	29141-93J00	91	33220-69J00	20	38100-99E01-02	27
REC17471-92J00		REC17660-99E01		REC95380-06700		REC33220-98J00		REC38100-99E01-OEP	
17471-87E01	104	17670-87J00	38	29141-93J00	93	33220-76Q00/1/2	20	38100-99E01-OEP/OED	27
REC17471-92J00		REC17670-87J00		REC95380-06700		REC33220-76Q02		REC38100-99E01-OEP	
17471-87L01	41	17670-90J01	67	29141-93J00	95	33220-84M10	20	38410-89J00	24
REC17471-87L01		REC67F-12411-01		PAGB/16184-2000		REC33220-84M10		REC89-825096T01	
17471-92J00	107	17670-90J10	38	29141-93J00	97	33220-98J00	20	38410-93J12/11/10/00	31
REC17471-92J00		REC17670-90J10		REC95380-06700		REC33220-98J00		REC38410-93J12	
17471-92J00	107	17680-92J00	38	29162-93J00	101	33410-87J00/01	21	38410-93J12	31
REC17471-92J00		REC17680-92J00		PAGB/193-6		REC33410-87J01		REC38410-93J21	
17471-92J00	109	17670-91J00/1	38	29162-93J00	103	33410-87L00	21	38410-94550/1/2	24
REC17471-92J00		REC17670-91J01		PAGB/193-6		REC33410-87L00		REC89-825096T01	
17471-92J00/1/2	41	17670-93962	38	29162-93J00	91	33410-89L00/10/11	21	38410-94550/51/52	31
REC17471-92J02		REC17670-93962		PAGB/193-6		REC33410-89L11		REC6E5-8195A-01	
17471-92J00	41	17670-93J00	38	29162-93J00	93	33410-90J00	21	38860-76F01	25
REC17471-92J00		REC67F-12411-01		PAGB/193-6		REC33410-90J00		REC38860-76F01	
17471-93902	41	17670-94400	38	31000-89J00	24	33410-93E10	21	41151-94500	37
REC17471-93902		REC17670-94400		REC31100-89J00		REC33410-94400-000		REC41151-94500	
17471-93902	93	17670-94J00/1	38	31100-87J00	24	33410-93J00	21	41212-93001-OEP/OED	37
REC17471-93902		REC17670-94J01		REC31100-87E00		REC33410-93J00		REC41212-93001-OEP	
17471-93J02	111	17685-87D00/10	39	31100-87J00	24	33410-94400-000	21	41212-93001-OEP	37
REC17471-93J02		REC17685-87D10		REC31100-87J00		REC33410-94400-000		REC41212-93001-OEP	
17471-94401	101	17685-87D10	58	31100-87D00/10	24	33410-94J00	21	41810-87D00	47
REC17471-94401		REC17685-87D10		REC31100-					

48610-93J00/1 REC48610-98L00	29	54130-96310/20 REC54130-96320	36	55320-95311 REC55320-95311AL	47	56130-94411-0EP REC56130-94413-0EP	42	57610-96311 REC57610-96311	97
48610-98L00 REC48610-98L00	29	54160-94410 REC54160-94410	36	55320-95311AL REC55320-95311AL	115	56130-94413-0EP REC56130-94413-0EP	42	57610-96311 REC57610-96311	99
48630-92J00 REC48630-92J00	29	55120-87801 REC55120-87801	49	55320-98311 CM55320-98310	50	56130-96320-0EP REC56130-96331-0EP	42	57621-87J00/1/2/3 REC57621-94403	119
48630-92J00 REC48630-92J00	30	55120-87801 REC55120-87801AL	49	55320-98311 CM55320-98310	50	56130-96320-0EP REC56130-96331-0EP	42	57621-87J00 REC57621-94403	101
48630-93J00 REC48630-93J00	30	55122-88100 REC55122-94400	103	55320-98400 REC55320-98400	48	56132-95J00 REC56132-95J00	45	57621-87J00 REC57621-94403	103
48630-94900 REC48630-94900	29	55122-88100 REC55122-94400	45	55320-98400 REC55320-98400AL	48	56132-95J00 REC56132-95J00	97	57621-91110 REC57621-91110	119
48630-94900 REC48630-94900	30	55122-93100 REC55122-93100	121	55320-98400 CM55320-98400	50	57100-93902 REC57100-93902	93	57621-92J10/20 REC57621-92J20	119
48630-96J00 REC48630-96J00	30	55122-98100 REC55122-98100	115	55320-98400 CM55320-98400A	50	57110-93J21 REC57110-93J21	112	57621-92J20 REC57621-92J20	109
48630-96J01/2/3 REC48630-96J03	30	55122-98100 REC55122-98100	121	55320-98600 REC55320-98600	51	57110-93J30/31 REC57110-93J31	117	57621-94400/3 REC57621-94403	119
48630-96J03 REC48630-96J03	29	55125-97801 CM55125-87D00	51	55320-98600 REC55320-98600A	51	57110-93131 REC57110-93131	112	57621-95300/10 REC57621-91110	119
48630-98L00/1 REC48630-98L01	30	55125-87801 CM55125-87D00A	51	55321-87J00 REC55321-87J01AL	103	57130-94301 REC57130-94301	118	57630-90J00 REC57630-90J00	109
50040-93829-0EP REC528-B25F	87	55125-87D00 CM55125-87D00	51	55321-87J00 REC55321-87J01AL	105	57292-94300 PAGB/1896-6	34	57630-90J00 REC57630-90J00	125
50040-93839-0EP REC521-B25F	87	55125-87D00 CM55125-87D00A	51	55321-87J00/1 CM55321-87J00	50	57300-93860 REC57300-93860	112	57630-92E00 REC57630-92E00	111
50040-93840-0EP REC521-B25F	87	55125-87E01 REC55125-95500A	49	55321-87J00/1 CM55321-87J00A	50	57300-96810 REC57300-96810	111	57630-92E00 REC57630-92E00	112
50040-93851-0EP REC528-B25F	87	55125-87E01 REC55125-95500AL	49	55321-87J01 REC55321-87J01AL	89	57300-96850 REC57300-96850	111	57630-92E00 REC57630-92E00	113
50060-93839-0EP REC528-B30F	87	55125-87E01 CM55125-95500	51	55321-87J01 REC55321-87J01AL	93	57310-93950 REC57310-93950	123	57630-92E00 REC57630-92E00	125
50060-93839-0EP REC521-B30F	87	55125-87E01 CM55125-95500A	51	55321-87J01 REC55321-87J01	48	57311-90L00 REC57311-93910	122	57630-94300 REC57630-94300	103
50060-93840-0EP REC521-B30F	87	55125-90J01 REC55125-90J01AL	104	55321-87J01 REC55321-87J01AL	48	57311-91J00 REC57311-98600	89	57630-94300/1 REC57630-94300	125
50060-93851-0EP REC528-B30F	87	55125-90J01 REC55125-90J01AL	105	55321-87J01 REC55321-87J01AL	55	57311-91L00 REC57311-96311	122	57630-94301 REC57630-94300	101
5100-94J03 REC15100-94J03	12	55125-90J01 REC55125-90J01AL	107	55321-87J01 REC55321-87J01AL	56	57311-93901 REC57311-93901	122	57630-94500 REC57630-94500	104
51116-93J01 REC51116-93J01	67	55125-90J01 REC55125-90J01AL	109	55321-87J01 REC55321-87J01AL	57	57311-93910 REC57311-93910	122	57630-94500 REC57630-94500	125
51123-87L00 REC51123-87L00	70	55125-90J01 REC55125-90J01AL	112	55321-87J01 REC55321-87J01AL	58	57311-93910 REC57311-93910	93	57630-96300 REC57630-96300	125
51123-87L00 REC51123-87L00	62	55125-90J01 REC55125-90J01	49	55321-87J01 REC55321-87J01AL	59	57311-94401/2 REC57311-94402	122	57630-96300 REC57630-96300	99
51123-88L00 REC11400-88872	59	55125-90J01 REC55125-90J01AL	49	55321-87J01 REC55321-87J01AL	60	57311-96310/11/20 REC57311-96311	122	57630-99J00 REC57630-99J00	91
51123-88L00 REC51123-88L00	72	55125-91L01 REC55125-91L01	49	55321-87J01 REC55321-87J01AL	61	57311-96320 REC57311-96320	97	57631-93901 REC57631-93901	120
51123-88L00 REC51123-88L00	72	55125-91L01 REC55125-91L01AL	49	55321-87J01 REC55321-87J01AL	62	57311-96320 REC57311-96320	99	57631-93901 REC57631-93901	91
51123-93J00 REC51123-93J00	67	55125-95002 CM55125-94502	49	55321-87J01 REC55321-87J01AL	63	57311-97110 REC57311-99J10	95	57631-93901 REC57631-93901	95
51123-93J00 REC51123-93J00	72	55125-94502 CM55125-94502	49	55321-87J01 REC55321-87J01AL	65	57311-98400 REC57311-98400	122	57631-94700 REC57631-95303	120
51123-96J01/2 REC51123-96J02	65	55125-94502 CM55125-94502	51	55321-87J01 REC55321-87J01AL	67	57311-98600/1 REC57311-98600	122	57631-95301/2/3 REC57631-95303	120
51123-96J02 REC51123-96J02	65	55125-95301 CM55125-95301A	51	55321-87J01 REC55321-87J01AL	68	57311-99100 REC57311-99J10	122	57631-95303 REC57631-95303	101
51123-98L00 REC51123-98L00	68	55125-95301 CM55125-95301A	51	55321-87J01 REC55321-87J01AL	91	57311-99100 REC57311-99J10	122	57631-95303 REC57631-95303	103
51123-98L00 REC51123-98L00	72	55125-95500 REC55125-95500AL	101	55321-87J01 REC55321-87J01AL	95	573311-96320 REC573311-96320	122	57631-96301 REC57631-96301	120
51124-93J00/1 REC51124-93J01	75	55125-95500 REC55125-95500AL	103	55321-87J01 REC55321-87J01AL	95	57510-89J00 REC57510-89J00	123	57631-96301 REC57631-96301	99
51124-93J00/1 REC51124-93J01	75	55125-95500 REC55125-95500AL	49	55321-90J01 REC55321-90J01AL	104	57510-89J00 REC57510-89J00	123	57631-96301 REC57631-96301	99
51124-93J01 REC51124-93J01	65	55125-96310 CM55125-96310	51	55321-90J01 REC55321-90J01AL	109	57510-89J00 REC57510-89J00	99	57632-93902 REC57632-94J00	126
51124-93J01 REC51124-93J01	67	55125-96310 CM55125-96310A	51	55321-90J01 REC55321-90J01	48	57510-89J00 REC57510-89J00	123	57632-93L00/1 REC57632-93L01	111
51124-93J01 REC51124-93J01	68	55125-96310 REC55125-96310A	97	55321-90J01 REC55321-90J01AL	48	57510-91J00 REC57510-91J00	123	57632-93L01 REC57632-93L01	120
51142-93J00 REC51142-93J00	67	55125-96310 REC55125-96310A	99	55321-90J01 CM55321-90J01	51	57510-91J00 REC57510-91J00	89	57632-93L01/11 REC57632-93L11	126
51142-93J00 REC51142-93J00	71	55125-98J00 PAGB/197.1-B	111	55321-90J01 CM55321-90J01A	51	57510-91J00 REC57510-91J00	123	57632-93L11 REC57632-93L11	120
51142-96J00 REC51142-96J00	65	55125-98J00 REC55125-90J01AL	111	55321-90L00 REC55321-90L00	48	57510-93902 REC57510-93902	123	57632-93L11 REC57632-93L11	126
51142-96J00 REC51142-96J00	71	55128-93L10 REC55128-93L10	111	55321-90L00 REC55321-90L00A	48	57510-93902 REC57510-93902	123	57632-94J00 REC57632-94J00	126
51142-98L00 REC51142-98L00	68	55128-93J10 REC55128-93J10	112	55321-93900 CM55321-93900	51	57510-93910 REC57510-93910	93	57632-94J00 REC57632-94J00	126
51142-98L00 REC51142-98L00	71	55128-93J10 REC55128-93J10	112	55321-93900 CM55321-93900A	51	57510-94400/1/2 REC57510-94402	123	57632-94J00 REC57632-94J00	91
51211-87J00 REC51211-87J00	58	55128-93J10 REC55128-93J10	113	55321-93900 REC55321-93900AL	93	57510-98600 REC57510-98600	123	57632-94J00 REC57632-94J00	95
51211-87J00 REC51211-87J00	70	55128-93L00 REC55128-93L00	113	55321-95J00 REC55321-95J00	47	57510-98600/11 REC57510-89J00	123	57632-97L00 REC57632-97L00	120
51211-87J00/10 REC51211-87L10	60	55128-93L00 REC55128-93L00	115	55321-95J00 REC55321-95J00AL	47	57510-99110 REC57510-99110	95	57632-97L00 REC57632-97L00	91
51211-87J00/10 REC51211-87L10	70	55128-93L00 REC55128-93L00	117	55321-95J00 REC55321-95J00AL	57	57510-99111 REC57510-99111	123	57632-97L00 REC57632-97L00	95
51211-88L00 REC51211-88L00	59	55300-95500 REC55300-95500AL	101	55321-95J00 REC11400-87804	57	57521-89J00 REC57521-89J00	123	57632-97L00 REC57632-97L00	93
51211-88L00 REC51211-88L00	70	55300-95500 REC55300-95500AL	103	55321-99E00 REC68L-11325-00	47	57521-89J00 REC57521-89J00	97	57632-97L00 REC57632-97L00	120
51211-89J00 REC51211-89J00	55	55300-95500 REC55300-95500	48	55321-99E00 REC68L-11325-00AL	47	57521-89J00 REC57521-89J00	99	57632-98501 REC57632-98501	89
51211-89J00 REC51211-89J00	70	55300-95500 REC55300-95500AL	48	55321-99E00 REC68L-11325-00AL	54	57521-91J00 REC57521-91J00	123	57632-98501/1/2 REC57632-98502	126
51211-90J00/01/02/10 REC51211-90J10	50	55300-95500 CM55300-95500	50	56120-93900/10/30-0EP REC56120-87L30-0EP	118	57521-91J00 REC57521-91J00	123	57633-90J02 REC57633-90J02	109
51211-90J10 REC51211-90J10	61	55300-95500 CM55300-95500A	50	56120-87L30-0EP REC56120-87L30-0EP	105	57521-91J00 REC57521-91J00	89	57633-90J02 REC57633-90J02	109
51211-90J20 REC51211-90J20	61	55300-95500 REC55300-95500AL	91	56120-90L00/1/2-0EP REC56120-93900	118	57521-91J00 REC57521-91J00	89	57633-93900/1 REC57633-93901	126
51211-90J20 REC11410-90823	70	55300-95500 REC55300-95500AL	93	56120-92J00/1-0EP REC56120-92J01-0EP	118	57521-93902 REC57521-93902	123	57633-93901 REC57633-93901	91
51211-90J21/22 REC51211-90J2	62	55300-95500 REC55300-95500AL	99	56120-92J01-0EP REC56120-92J01-0EP	109	57521-93902 REC57521-93902	123	57633-93901 REC57633-93901	93
51211-90J22 REC51211-90J2	70	55320-93900 CM55321-93900	51	56120-92J01-0EP REC56120-92J01-0EP	118	57521-93910 REC57521-93910	93	57633-93901 REC57633-93901	95
51211-90J30 REC51211-90J30	63	55320-93900 CM55321-93900A	51	56120-93900-002M REC56120-93900	118	57521-94400/1 REC57521-94400	123	57634-88L00 REC57634-88L00	101
51211-90J30 REC51211-90J30	70	55320-93900 CM55125-87D00	51	56120-93900/1-0EP REC56120-93900	118	57521-94400/1/2 REC57521-94402	123	57634-88L00 REC57634-88L00	103
51211-93J00 REC51211-93J00	67	55320-93900 CM55125-87D00A	51	56120-93901-0EP REC56120-93900	93	57521-99110 REC57521-99110	123	57634-88L00 REC57634-88L00	119
51211-93J00 REC51211-93J00	70	55320-94900 REC55320-94900	48	56120-93J00/1/2/3-0EP REC56120-93J50-0EP	118	57521-99110 REC57521-99110	91	58100-89L00-019 SOL4111-093-07A	128
51211-94L00 REC51211-94L00	70	55320-94900 REC55320-94900AL	48	56120-93J50-0EP REC56120-93J50-0EP	118	57521-99110 REC57521-99110	95	58100-89L20-019 SOL4111-093-09A	128
51211-96J00 REC51211-96J00	65	55320-94900 CM55321-94900	51	56120-93L00-0EP REC56120-94321-0EP	103	57610-92J20 REC57610-92J20	126	58100-89L50-019 S	

58100-90J20-019	128	63610-91J20	34	99105-0020L-18P	129
SOL3451-139-21		REC63610-91J20		SOL4552-148-18	
58100-90J22-019	128	63610-93501-000	34	99105-0020L-20P	129
SOL3451-139-23		REC63610-93501		SOL4512-145-19	
58100-90J40-019	128	63610-94402-000	34	99105-0020L-20P	129
SOL3413-138-15		REC63610-94402		SOL4552-148-20	
58100-90L41-019	128	63610-96302-000	34	99105-0020L-22P	129
SOL411-093-08A		REC63610-96302		SOL4512-143-21	
58100-94302-019	128	63610-96321-000	34	99105-0020L-24P	129
SOL4311-121-09		REC63610-96321-000		SOL4512-142-23	
58100-94313-019	128	65720-94403	10	99105-0020L-24P	129
SOL4311-116-13		REC65720-94403		SOL4552-140-24	
58100-94500-019	128	65720-94411	10	99105-00700-18P	128
SOL4411-135-15		REC65720-94411		SOL3451-139-17	
58100-94500-019	128	65720-98500/1/2	10	99105-00700-20P	128
SOL4431-135-15		REC65720-98520		SOL3451-139-19	
58100-94512-019	128	65720-98520/1	10	99105-00700-22P	128
SOL4411-133-17		REC65720-98520		SOL3451-139-21	
58100-94512-019	128	65720-98511	10	99105-00700-24P	128
SOL4431-133-17		REC65720-98520		SOL3451-139-23	
58100-94522-019	128	65720-986A0	10	99105-0070L-18P	128
SOL4411-130-19		REC65720-986L0		SOL3452-139-17	
58100-94522-019	128	65720-986B0	10	99105-0070L-20P	128
SOL4431-130-19		REC65720-986L0		SOL3452-139-19	
58100-94532-019	128	65720-986L0	10	99105-0070L-22P	128
SOL4411-130-21		REC65720-986L0		SOL3452-139-21	
58100-94532-019	128	65740-95D00	10	99105-11002-008	34
SOL4431-130-21		REC65740-95D01		PRE3300C08	
58100-94554-019	128	65740-99100	10	99105-11002-009	34
SOL4431-135-15		REC65740-99100		PRE3300C09	
58100-94561-019	128	65750-87J11	10	99105-11002-010	34
SOL4431-130-19		REC65750-87J11		PRE3300C10	
58100-94571-019	128	65750-94404/3/2/1	10	99105-11002-011	34
SOL4431-130-21		REC65750-94404		PRE3300C11	
58100-94581-019	128	65750-98506	10	99105-11002-012	34
SOL4431-133-17		REC65750-98506		PRE3300C12	
58100-95212-019	128	65750-98506	10	99105-11002-013	34
SOL4311-120-10		REC65750-98505		PRE3300C13	
58100-95222-019	128	65770-90J12	10	99105-11002-014	34
SOL4311-118-11		GS31095		PRE3300C14	
58100-95353-019	128	65770-93J12	10	99105-11002-015	34
SOL4311-116-14		GS31090		PRE3300C15	
58100-95363-019	128	65770-95541	10	99105-11002-016	34
SOL4311-110-15		GS31187		PRE3300C16	
58100-95393-019	128	65910-98J00	11	99105-11002-017	34
SOL4311-116-12		REC90794-46913		PRE3300C17	
58100-95511-019	128	67200-88L00	32	99105-11002-018	34
SOL2431-135-15		REC67200-88L00		PRE3300C18	
58100-95521-019	128	67200-88L10	32	99105-11002-019	34
SOL2431-133-17		REC67200-88L10		PRE3300C19	
58100-95530-019	128	67200-91J00/01/04	33	99105-11002-020	34
SOL2431-130-19		REC67200-94J20		PRE3300C20	
58100-95D00-019	128	67200-93J00/1/2/3/4/6	33	99105-11002-021	34
SOL4211-109-14		REC67200-93J51		PRE3300C21	
58100-96410-019	128	67200-93J12/1/3	32	99105-11002-022	34
SOL4211-110-09		REC67200-88L00		PRE3300C22	
58100-96420-019	128	67200-93J15	32	99105-11002-023	34
SOL4211-105-11		REC67200-88L10		PRE3300C23	
58100-96430-019	128	67200-93J30	33	99105-11002-024	34
SOL4211-103-12		REC67200-93J30		PRE3300C24	
58100-96440-019	128	REC663-48344-00		99105-11002-025	34
SOL4211-101-13		67200-93J50/51	33	PRE3300C25	
58100-96460-019	128	REC67200-93J51		99105-11002-026	34
SOL4211-100-15		67200-94J20	33	PRE3300C26	
58100-91JN0-019	128	REC67200-94J20		99105-11002-027	34
SOL4011-079-075		67200-99E10/30-OEP	33	PRE3300C27	
58100-91JN0-019	89	REC67200-99E56		99105-11002-028	34
SOL4011-079-075		67200-99E50/51/56	33	PRE3300C28	
58200-87D01-019	129	REC67200-99E56		99105-11002-029	34
SOL4513-145-17		67256-95600	34	PRE3300C29	
58200-87D02-019	129	PAF15-13010010W		99105-11002-030	34
SOL4552-148-18		67275-95600	34	PRE3300C30	
58200-87D11-019	129	PAF25-07000007W		R12140-98J10	77
SOL4513-143-19		PAF15-08000002		REC12140-98J10	
58200-87D11-019	129	67631-93901	93		
SOL4551-148-20		REC67631-93901			
58200-87D12-019	129	90119-08M14	115		
SOL4552-148-20		REC90119-08M14			
58200-87D21-019	129	90171-18M04	112		
SOL4513-140-21		REC90171-18M04			
58200-87D61-019	129	90171-18M04	113		
SOL4513-148-15		REC90171-18M04			
58200-87D61-019	129	90171-18M04	115		
SOL4551-148-16		REC90171-18M04			
58200-87D62-019	129	91490-30025	112		
SOL4552-148-16		REC91490-30025			
58500-98L00	129	91490-30025	115		
SOL4652-155-210		REC91490-30025			
58500-98L10	129	93606-12019	115		
SOL4652-155-225		REC93606-12019			
58500-98L20	129	93606-12019	115		
SOL4652-155-240		REC93606-12019			
58500-98L30	129	990F0-41005-OED	9		
SOL4652-155-255		GS90025			
58500-98L60	129	990F0-41005-OEP	9		
SOL4652-155-195		GS90042			
58500-98L90	129	990F0-41005-QTN	9		
SOL4652-155-180		GS90052			
58520-98L00	115	990F0-41005-Y5S	9		
SOL17047301		GS90051			
58600-98L01	129	990F0-41005-YAY	9		
SOL4653-141-210		GS90050			
58600-98L11	129	99105-00100-16P	128		
SOL4653-141-225		SOL4431-135-15			
58600-98L21	129	99105-00100-18P	128		
SOL4653-141-240		SOL4431-133-17			
58600-98L31	129	99105-00100-20P	128		
SOL4653-141-255		SOL4431-130-19			
58600-98L61	129	99105-00100-22P	128		
SOL4653-141-195		SOL4431-130-21			
58600-98L91	129	99105-00200-16P	129		
SOL4653-141-180		SOL4511-150-15			
58620-98L00	115	99105-00200-16P	129		
SOL17047302		SOL4551-148-16			
59178-97J00	117	99105-00200-16P	129		
REC59178-97J00		SOL4511-150-15			
59178-97J00	89	99105-00200-18P	129		
REC59178-97J00		SOL4511-148-17			
59178-97J00	91	99105-00200-18P	129		
REC59178-97J00		SOL4511-155-17			
59178-97J00	95	99105-00200-20P	129		
REC59178-97J00		SOL4511-145-19			
6120-93J50-OEP	111	99105-00200-20P	129		
REC6120-93J50-OEP		SOL4551-148-20			
61610-90L00	37	99105-00200-20P	129		
REC61610-90L00		SOL4511-153-19			
61610-93900/1	37	99105-00200-22P	129		
REC61610-90L00		SOL4511-143-21			
61610-93E01	37	99105-00200-22P	129		
REC61610-90L00		SOL4511-153-21			
61616-93E00	37	99105-00200-24P	129		
REC61616-93E00		SOL4511-142-23			
61616-93E01	37	99105-00200-24P	129		
REC61616-93E01		SOL4511-150-24			
63610-89E01-000	34	99105-0020L-16P	129		
REC63610-89E01		SOL4512-150-15			
63610-91J00/1/3/4	34	99105-0020L-16P	129		
REC63610-91J20		SOL4552-148-16			

**WARRANTY AND RETURN POLICY**  
**POLÍTICA DE GARANTIA Y DEVOLUCIÓN**  
**POLITICA DI GARANZIE E REGOLE PER I RESI MERCE**  
**POLITIQUE DE GARANTIE ET RETOUR DE PIÈCES**

## RECMAR WARRANTY POLICY

All products sold by **Recambios Marinos S.L.U.** must be installed and used by competent personnel under their exclusive responsibility. **Recambios Marinos S.L.U.** shall not be responsible for the consequences of the faulty or improper installation of any item that does not include installation solutions.

The fitter will be responsible for checking that the manufacturer recommendations have been followed correctly in terms of compatible uses.

Articles sold by **Recambios Marinos S.L.U.** are covered by legal warranty of conformity, in accordance with Royal Decree-Law 7/2021, of April 27 (hereinafter, RDL 7/2021), approving the recast text of the general law on consumer and user protection.

**Recambios Marinos S.L.U.** distribute the products only to professionals and never to privates of final clients. The cost of installing the part would never be included in the price for which reason, **Recambios Marinos S.L.U.** would never be responsible for its installation.

Articles sold by **Recambios Marinos S.L.U.** are covered by warranty for manufacturing defects for a limited period of time that may vary between 3 years and 3 months, depending on the product, application and type of boat it is installed on (7th/6th/5th list), except for the articles considered consumable, light

bulbs, electrical products, batteries and others that are not covered at all. For information on the exact warranty period of an article, please contact the Sales Department.

In the case of damage caused during shipping, article 366 of the Code of Commerce will apply. The article says: "Claims to the delivery company may be made within 24 hours from receiving the goods. Once this term has elapsed, or the freight costs have been paid, claims to the delivery company with regard to the condition of the goods can no longer be made." The goods that **Recambios Marinos S.L.U.** sends every day to its customers are examined before being packed to ensure their perfect integrity and avoid damage during shipping. Remember that it is essential to check the goods in the presence of the dispatcher. If the package is damaged, the dispatcher's delivery note must mention what type (CONFORMING GOODS, UNLESS INSPECTED), and must be signed by you and by the dispatcher. If you receive damaged goods for these reasons you must notify both the dispatcher and **Recambios Marinos S.L.U.** to be able to make the claim to the relevant delivery company.

### WARRANTY CLAIMS

Warranties are always subject to **Recambios Marinos S.L.U.** Technical Department's assessment. The assessment will be carried out on **Recambios Marinos S.L.U.**'s premises or, if necessary, by the article's manufacturer. In both cases, the article must be physically on **Recambios Marinos S.L.U.**'s premises in Viladecans. Assessment time will not exceed 30 calendar days from receiving the article.

To return the faulty item, visit [www.recambiosmarinos.es](http://www.recambiosmarinos.es), go to your account and select PROCESS WARRANTY in the private section. From there you will be able to download the file to claim the warranty of engines and

parts and follow the instructions.

**Recambios Marinos S.L.U.** will not charge for the loan of the replacement during the warranty process.

**Only guarantees that have been correctly processed from the "process guarantee" request section of the customer area on our website [www.recambiosmarinos.es](http://www.recambiosmarinos.es) will be accepted. All guarantee queries arising from different channels such as telephone, email or sales references will not be processed until the process has been correctly completed from the website.**

### WARRANTY EXCLUSIONS

**Recambios Marinos S.L.U.** shall not be responsible for product faults in the following cases:

- Normal wear and tear of a product. Installation faults or improper use.
- Installation of an article not designed for the model in question.
- Damage due to external causes (accidents, lightning, power surges...)
- Defects and consequences of transport.
- Alterations to installations or to boats intended for competitions.

If the warranty is refused, the customer may retrieve the faulty article by contacting **Recambios Marinos S.L.U.** via email and requesting that the article is returned to them within 7 calendar days from the day the warranty was refused.

**Recambios Marinos S.L.U.** does not apply the warranties offered from time to time by manufacturers.

**Returns of material from the warranty processing section of our website [www.recambiosmarinos.es](http://www.recambiosmarinos.es) will not be accepted, the amount of which is less than €30.**

## RETURN POLICY FOR PARTS IN STOCK

To help our customers maintain their stock correctly, **Recambios Marinos S.L.U.** will allow any parts ordered by mistake to be returned.

Goods with a value below €30 may not be returned.

### FORMAL REQUIREMENTS:

Goods returned must be accounted for in a delivery note. Neither the goods nor the packaging must be damaged. Goods that do not meet any of these requirements will not be accepted under any circumstance. Goods may be returned via the private section of the website [www.recambiosmarinos.es](http://www.recambiosmarinos.es)

Once the return has been processed correctly, you will receive a label with the registration number that must be included in the package, properly sealed and with the label visible, so that your package can be located in our facilities and the request can be processed as soon as possible.



DEVOLUCIÓN DE MATERIAL
EXPEDIENTE Nº:
<b>700486</b>
RMP1168196
<small>Por favor recorte esta hoja por la línea de puntos y péguela en un lugar visible del exterior del paquete.</small>

### TERMS:

Goods must be returned maximum within 30 calendar days from the date the goods were shipped from our premises. The deadline to return goods will be maximum 15 calendar days from the date the return pre-authorization number is received (it will be automatically provided by **Recambios Marinos S.L.U.** during the return process)

### CONDITIONS:

Under no circumstances will **Recambios Marinos S.L.U.** accept the following articles:

- Footwear.
- Electrical goods.
- Custom-made goods.
- Anodes, anchors, chains, hoses.
- Obsolete or discontinued articles.
- Thrusters, pneumatics, paddle surfing boards and Parsun engines.
- Oils, paints, greases, liquids, including all cleaning and maintenance products in general.
- **Electrical material**
- **Propellers**
- **Anodes**
- **Hoses**

### DAMAGE DURING TRANSPORT:

Article 366 of the Code of Commerce will apply. The article says: "Claims to the delivery company may be made within 24 hours from receiving the goods. Once this term has elapsed, or the freight costs have been paid, claims to the delivery company with regard to the condition of the goods can no longer be made."

The materials that **Recambios Marinos S.L.U.** sends every day to its customers are examined before being packed to ensure their perfect integrity and avoid damage during shipping. Remember that it is essential to check the goods in the presence of the dispatcher. If the package is damaged, the dispatcher's delivery note must mention what type (conforming goods, unless inspected), and must be signed by you and by the dispatcher, if you receive damaged goods for these reasons you must notify both the dispatcher and **Recambios Marinos S.L.U.** to be able to make the claim to the relevant delivery company.

All previously authorised returned goods must be sent to **Recambios Marinos S.L.U.** visibly specifying the return number.

**Within twenty-four hours of receipt of the goods, a claim may be made against the assigned transport company.**

**Once the stated terms have elapsed or the freight has been paid, no claim will be accepted against the carrier regarding the condition in which the goods were delivered.**

### CREDITING:

**Recambios Marinos S.L.U.** will credit 90% of the amount originally charged of all returned goods (which comply with each and every formal requirement, terms and conditions). 10% is retained to cover the cost of returning the goods (handling, packaging, quality control...).

### RESERVATION OF OWNERSHIP:

**Recambios Marinos S.L.U.** retains ownership of all goods it supplies until the buyer pays for them in full.

## LIMITED WARRANTY OF THE RECAMBIOS MARINOS, S.L. PRODUCTS

The products of **Recambios Marinos S.L.U.** are warranted to be free from manufacturing defects for a period of:

**3 years from the date of purchase for the NEW products**

**1 year for the REBUILT products.**

**Products used for commercial, rental or income producing activity are warranted for: 90 days.**

In any case it will be essential to present the purchase invoice.

---

**Recambios Marinos S.L.U.** not warrant or make any representations in respect to installation errors made by a servicing dealer, servicing mechanic or the individual. This warranty applies to manufacturing defect only, it does not apply to the following:

- alteration, removal of parts,
- adjustments, tune-up
- damages due to accident
- improper installation or service
- misuse, neglect
- lack of maintenance
- use of any accessory or part not sold by Recambios Marinos
- operation with fuels, oils or lubricants which are not suitable for use with the product.

Recambios Marinos liability under this warranty shall be terminated on any part damaged by:

- flood
- fire
- storm
- other natural acts
- where the model number and other identification has been altered, defaced or removed.

---

Recambios Marinos will not be liable for any charges like:

- **labor charges**
- fuel
- towing
- ramp
- lift
- trips
- special or indirect damages resulting from the product or caused by the defect or reasonable delay in correcting the defect

**These items are not covered by this warranty.**

Recambios Marinos reserves the right to inspect and determine whether or not any part failed due to a manufacturing defect. Do not disassemble any parts. Recambios Marinos reserves the right to credit, refund your purchase price for the product rather than repair or replace the product or any part thereof.

Any part is covered only for the original warranty period. Once the warranty on the product has expired, the warranty on any replaced or repaired part also expires. We shall be allowed to keep parts it deems defective under this warranty.

---

Recambios Marinos does not warrant, guarantee or make any representations regarding the use or the results of the use of the product in terms of its correctness, reliability or otherwise. The entire risk as to the result and performance of the product is assumed by customer.

---

The liability to you for actual damages from any cause, will be limited to the purchase price paid for the product.

---

No Recambios Marinos dealer, agent or employee is authorized to make any modification or extension to this warranty.

---

Process:

- You are required to notify Recambios Marinos any defect within the applicable warranty period and immediately obtain a warranty application and a RGA number (warranty claim number).
- Upon we receive the completed warranty application and part claimed under this warranty with the RGA number marked on the shipping and packing of the part, Recambios Marinos will inspect the part for warranty coverage.
- Only when the defect is covered by the warranty will the part be repaired or replaced.
- If warranty service is required, you must deliver your product at your expense, with proof of purchase.
- When the repair is completed, Recambios Marinos will ship back. Shipping methods will be determined by Recambios Marinos.

You can contact with our warranty department through:

**garantias@recmar.es postventa@recmar.es**

---

This warranty comprises the sole and entire warranty pertaining to the product furnished to you by Recambios Marinos. Any other representations or promises by any person are unauthorized and are not binding upon Recambios Marinos unless in writing.

## POLÍTICA DE GARANTÍAS RECMAR

Todos los productos comercializados por **Recambios Marinos S.L.U.** deben ser instalados y utilizados por personal competente bajo su exclusiva responsabilidad. **Recambios Marinos S.L.U.** no se responsabiliza de las consecuencias producidas por una instalación defectuosa o inapropiada de ningún artículo que no incluya soluciones de instalación.

El instalador será el responsable de verificar la correcta aplicación de las recomendaciones del fabricante en cuanto a compatibilidades de uso.

Los artículos comercializados por **Recambios Marinos S.L.U.** están amparados por la garantía legal de conformidad, conforme a las condiciones expuestas en el real decreto legislativo Real Decreto-Ley 7/2021, de 27 de abril (en adelante, RDL 7/2021), aprobación del texto refundido de la ley general para la defensa de los consumidores y usuarios.

**Recambios Marinos S.L.U.** distribuye los artículos presentes en sus catálogos únicamente a profesionales, nunca a particulares o cliente final, el importe de la instalación jamás estará incluido en el precio por lo que no será responsable de ésta.

Los artículos comercializados por **Recambios Marinos S.L.U.** disponen de una garantía limitada por defectos de fabricación, los periodos pueden variar entre los 3 años y los 3 meses dependiendo del producto, aplicación y tipo de embarcación (lista 7ª/

6ª/ 5ª), descartando los artículos considerados como consumibles: bombillas, productos eléctricos, baterías y otros que carecen de periodo alguno, si necesita conocer el plazo exacto del producto contacte con el departamento comercial.

Por daños ocasionados en el transporte, se aplicará lo indicado en el artículo 366 de Código de Comercio, que dice : "Dentro de las veinticuatro horas siguientes al recibo de las mercancías, podrá hacerse reclamación contra la empresa de transporte asignada. Transcurridos los términos expresados o pagados los portes, no se admitirá reclamación alguna contra el transportista sobre el estado en que se entregó la mercancía." El material que enviamos diariamente desde **Recambios Marinos S.L.U.** a nuestros clientes es examinado antes de empaquetarse para su perfecta integridad y evitar daños en el transporte. Recuerde que es muy importante inspeccionar las cargas en presencia del transportista. Cuando se observen daños en la caja, deberá incluirse en el albarán de entrega del transportista una mención del tipo (CONFORME MERCANCÍA, SALVO INSPECCIÓN), y deberá ser firmada por usted y el transportista. En caso de recibir material defectuoso por estas causas debe hacerlo constar tanto al transportista como a **Recambios Marinos S.L.U.** para poder reclamar a la empresa de transporte correspondiente.

### SOLICITUD DE GARANTÍA

La garantía siempre estará sujeta a la valoración final del departamento técnico de **Recambios Marinos S.L.U.** Esta valoración se llevará a cabo en nuestras instalaciones o en caso necesario por el fabricante del artículo, en ambas opciones el artículo tiene que estar físicamente en nuestras instalaciones centrales de Viladecans. El tiempo para la resolución será un máximo de 30 días naturales desde su recepción.

Para enviar el artículo defectuoso, debe ir a la pagina web [www.recambiosmarinos.es](http://www.recambiosmarinos.es), ir a su cuenta y seleccionar TRAMITAR GARANTÍA dentro del área privada, desde aquí podrá descargar el archivo para la solicitud de garantías de motores y piezas, y seguir las instrucciones.

**Recambios Marinos S.L.U.** no asumirá ningún préstamo de reemplazo durante el proceso de garantía.

**Solo se aceptarán las garantías que están tramitadas correctamente desde el apartado del área de clientes de solicitud de "tramitar garantía" en nuestra página web [www.recambiosmarinos.es](http://www.recambiosmarinos.es) Todas aquellas consultas referentes a garantías derivadas por diferentes canales como teléfono, correo electrónico o referencias de comercial, no se gestionaran hasta que no esté el trámite realizado correctamente desde la web.**

### EXCLUSIONES DE GARANTÍA

**Recambios Marinos S.L.U.** no podrá ser acusado como responsable del defecto ante:

- Desgaste normal del producto.
- Defectos de instalación o uso inadecuado.
- Instalación de un artículo no destinado a ese modelo.
- Daños por causa externa (accidente, rayo, fluctuación de corriente...)
- Defectos y consecuencias relacionadas con el transporte.
- Alteraciones en instalaciones o barcos destinados a la competición.

En caso de rechazo de la garantía, el cliente tiene la posibilidad de recuperar su artículo defectuoso poniéndose en contacto con nosotros vía e-mail solicitando la devolución del mismo dentro de los 7 días naturales siguientes a la fecha en que se le informó del rechazo de garantía.

**Recambios Marinos S.L.U.** no forma parte de las garantías comerciales anunciadas en ocasiones por los fabricantes.

**No se aceptarán devoluciones de material desde la sección de trámite de garantías de nuestra web [www.recambiosmarinos.es](http://www.recambiosmarinos.es), cuyo importe sea inferior a 30€**

## NORMAS PARA LA DEVOLUCIÓN DE PIEZAS EN STOCK

Con el fin de ayudar a nuestros clientes a mantener un stock correcto, **Recambios Marinos S.L.U.** aceptará la devolución de aquellas piezas que se hayan pedido por error.

No se aceptarán devoluciones de material cuyo importe sea inferior a 30€.

### REQUISITOS FORMALES:

El material a retornar, tiene que estar reflejado en un albarán. Ni el material ni el embalaje deben presentar desperfectos. Bajo ningún concepto se aceptarán devoluciones que no cumplan con alguno de estos puntos. La devolución se tramitará dentro del área privada desde la web [www.recambiosmarinos.es](http://www.recambiosmarinos.es)

**Al gestionar la devolución correctamente, se recibirá una etiqueta con el número de registro que se debe incluir en el paquete, correctamente precintado y con la etiqueta visible, para así poder localizar su paquete en nuestras instalaciones, y poder tramitar cuanto antes la petición.**



DEVOLUCIÓN DE MATERIAL

EXPEDIENTE Nº:

**700486**

RMP1168196

Por favor recorte esta hoja por la línea de puntos y péguela en un lugar visible del exterior del paquete.

### PLAZOS:

El plazo máximo para solicitar la devolución, será de 30 días naturales contados a partir de la fecha de expedición de la mercancía desde nuestras instalaciones. El plazo para la devolución de la mercancía será, como máximo, de 15 días naturales contados a partir de la fecha de recepción del número de pre-autorización de devolución (será notificado automáticamente por **Recambios Marinos S.L.U.** durante el proceso de devolución).

### CONDICIONES:

**Recambios Marinos S.L.U.**, no aceptará bajo ningún concepto la devolución de estos artículos:

- Calzado.
- Material eléctrico.
- Material solicitado por encargo.
- Ánodos, anclas, cadena, mangueras.
- Artículos obsoletos o descatalogados.
- Hélices, neumáticas, Paddle Surf y motores Parsun.
- Aceites, pinturas, grasas, líquidos, incluyendo cualquier producto de limpieza y mantenimiento en general.
- **Material eléctrico**
- **Hélices**
- **Ánodos**
- **Mangueras**

### DAÑOS OCASIONADOS POR EL TRANSPORTE:

Se aplicará lo indicado en el artículo 366 de Código de Comercio, que dice: "Dentro de las veinticuatro horas siguientes al recibo de las mercancías, podrá hacerse reclamación contra la empresa de transporte asignada. Transcurridos los términos expresados o pagados los portes, no se admitirá reclamación alguna contra el transportista sobre el estado en que se entregó la mercancía.

El material que enviamos diariamente desde **Recambios Marinos S.L.U.** a nuestros clientes es examinado antes de empaquetarse para su perfecta integridad y evitar daños en el transporte. Recuerde que es muy importante inspeccionar las cargas en presencia del transportista. Cuando se observen daños en la caja, deberá incluirse en el albarán de entrega del transportista una mención del tipo (CONFORME MERCANCÍA, SALVO INSPECCIÓN), y deberá ser firmada por usted y el transportista, en caso de recibir material defectuoso por estas causas debe hacerlo constar tanto al transportista como a **Recambios Marinos S.L.U.** para poder reclamar a la empresa de transporte correspondiente.

Todas las devoluciones de material que previamente hayan sido autorizadas se remitirán a **Recambios Marinos S.L.U.** indicando en el lugar visible el número de devolución.

**Dentro de las veinticuatro horas siguientes al recibo de las mercancías, podrá hacerse reclamación contra la empresa de transporte asignada.**

**Transcurridos los términos expresados o pagados los portes, no se admitirá reclamación alguna contra el transportista sobre el estado en que se entregó la mercancía.**

### ABONOS:

**Recambios Marinos S.L.U.** procederá a abonar todas las devoluciones (que cumplan todos y cada uno de los requisitos formales, plazos y condiciones) por un importe del 90% del facturado originalmente. El 10% restante irá destinado a soportar los costes originados por las devoluciones (manipulación, embalaje, control de calidad...).

### RESERVA DE PROPIEDAD:

**Recambios Marinos S.L.U.** se reserva el derecho de propiedad de todos los materiales que suministre hasta que el comprador haya satisfecho el pago total de los mismos.

# GARANTÍA LIMITADA DE RECAMBIOS MARINOS, S.L.U.

Los productos suministrados por **Recambios Marinos S.L.U.** están garantizados por defectos en el material o fabricación por un periodo de:

- 3 años desde la fecha de compra para productos NUEVOS**
- 1 año para los RECONSTRUIDOS.**

**Los productos utilizados con fines comerciales, de alquiler o uso profesional, están garantizados por un periodo de 90 días.**

En cualquier caso será imprescindible la presentación de la factura de compra.

**Recambios Marinos S.L.U.** no cubre en garantía y queda al margen de cualquier error de instalación que pudiera ocasionar el concesionario, servicio técnico, mecánico o cliente final. Esta garantía se refiere únicamente a defectos de fabricación y excluye los siguientes casos:

- modificación, desmontaje de las piezas
- ajustes
- desgaste normal
- daños producidos por accidente
- instalación defectuosa o mala manipulación
- mal uso, negligencia
- falta de mantenimiento
- uso de algún accesorio o pieza no vendida por Recambios Marinos
- funcionamiento con gasolina, aceites o lubricantes que no son adecuados para ese tipo de producto (no recomendado).

La responsabilidad de garantía de Recambios Marinos quedará anulada si la pieza está dañada por:

- inundación
- fuego
- tormenta
- cualquier otro elemento climatológico natural
- cuando el número de modelo u otra identificación haya sido alterada, modificada o borrada.

Recambios Marinos no será responsable de ningún cargo por:

- **mano de obra**
- combustible
- servicios de grúa o rampa
- remolcado
- desplazamiento
- otros gastos indirectos que resulten por causa del fallo del producto, por un defecto del mismo o por una demora razonable en corregir tal defecto.

**Estos conceptos no están cubiertos por esta garantía.**

Recambios Marinos se reserva el derecho de inspeccionar y determinar si la pieza ha fallado por causa de un defecto de fabricación. No desmante ninguna pieza. La obligación de Recambios Marinos estará limitada a reparar, reemplazar o abonar el producto una vez se haya identificado como defectuoso a su total discreción. También se reserva el derecho de abonar el importe a su precio de compra, antes que reparar o reemplazar el producto o algún componente del mismo.

Las piezas están cubiertas por esta garantía únicamente en su periodo original. Una vez el periodo de garantía ha expirado, la garantía de cualquier pieza reparada o sustituida expira también. Recambios Marinos podrá quedarse las piezas que considere defectuosas.

Recambios Marinos no garantiza ni se responsabiliza del uso o resultado de utilización del producto en términos de su funcionamiento, fiabilidad, etc. La totalidad del riesgo como resultado y funcionamiento del producto la asume el cliente.

La responsabilidad por cumplimiento de la garantía, estará limitado al precio de compra pagado por el producto.

Ningún concesionario de Recambios Marinos, agente o empleado está autorizado a hacer extensión o modificación alguna de esta política de garantías.

Proceso:

- Se deberá comunicar a Recambios Marinos cualquier defecto de producto que se encuentre dentro del periodo de garantía para obtener inmediatamente el impreso de solicitud de garantía y un número de RGA (expediente de garantía).
- Una vez Recambios Marinos haya recibido la solicitud de garantía y la pieza reclamada con el número de expediente, marcado en el embalaje de la pieza, se procederá a su revisión.
- Si el defecto está cubierto por la garantía, la pieza será reparada o reemplazada.
- Si se precisa reparación, deberán enviar a Recambios Marinos el producto a portes pagados con la prueba de compra.
- Cuando la pieza esté reparada, se devolverá por el sistema de envío determinado por Recambios Marinos.

Puede contactar con el Servicio Técnico de Recambios Marinos en:

**garantias@recmar.es postventa@recmar.es**

Esta garantía comprende única y exclusivamente la garantía relacionada con el producto que le ha suministrado Recambios Marinos. Otras garantías o compromisos efectuados por cualquier persona no autorizada, no son vinculantes para Recambios Marinos a menos que se haya autorizado previamente por escrito.

## POLITICA DI GARANZIE RECMAR

Tutti i prodotti commercializzati da **Recambios Marinos S.L.U.** devono essere installati e utilizzati da personale competente sotto la sua esclusiva responsabilità.

**Recambios Marinos S.L.U.** non è responsabile per le conseguenze di un'installazione difettosa o inadeguata di qualsiasi articolo che non includa soluzioni di installazione.

L'installatore è responsabile della verifica della corretta applicazione delle raccomandazioni del fabbricante in materia di compatibilità d'uso.

Gli articoli commercializzati dalla **Recambios Marinos S.L.U.** sono coperti dalla garanzia legale di conformità, conforme alle condizioni enunciate nel Regio decreto legge 7/2021, del 27 aprile (di seguito, RDL 7/2021), approvazione del testo consolidato della legge generale per la difesa dei consumatori e degli utenti.

**Recambios Marinos S.L.U.** distribuisce gli articoli presenti nei suoi cataloghi solo a professionisti, mai a privati o cliente finale, l'importo dell'impianto non sarà mai incluso nel prezzo e quindi non sarà responsabile di quest'ultimo.

Gli articoli commercializzati dalla **Recambios Marinos S.L.U.** dispongono di una garanzia limitata per difetti di fabbricazione, i periodi possono variare da 3 anni a

3 mesi a seconda del prodotto applicazione e tipo di imbarcazione ( elenco 7<sup>a</sup>/ 6<sup>a</sup>/ 5<sup>a</sup>), scartando gli articoli considerati come consumabili lampadine, prodotti elettrici, batterie e altri che non hanno alcun periodo di tempo, se avete bisogno di conoscere il tempo esatto del prodotto contattare il reparto commerciale.

Per i danni causati al trasporto si applica l'articolo 366 del codice di commercio che recita: "Entro 24 ore dal ricevimento delle merci, può essere presentato un reclamo nei confronti della società di trasporto designata. Alla scadenza dei termini espressi o pagati, non sono ricevibili reclami contro il trasportatore in merito allo stato in cui la merce è stata consegnata." Il materiale che inviamo quotidianamente da **Recambios Marinos S.L.U.** ai nostri clienti viene esaminato prima di essere confezionato per la sua perfetta integrità ed evitare danni al trasporto. Si ricorda che è molto importante ispezionare i colli alla presenza del vettore. In caso di danneggiamento della cassa, sul bollettino di consegna del trasportatore deve figurare un'indicazione del tipo (CONFORME MERCE, SALVO ISPEZIONE) e deve essere firmato dall'utente e dal trasportatore, in caso di ricezione di materiale difettoso per questi motivi deve essere messo a verbale sia al trasportatore che alla **Recambios Marinos S.L.U.** per poter reclamare all'impresa di trasporto interessata.

### RICHIESTA DI GARANZIA

La garanzia sarà sempre soggetta alla valutazione finale del Dipartimento Tecnico della **Recambios Marinos S.L.U.** Questa valutazione sarà effettuata presso la nostra sede o, se necessario, dal fabbricante dell'articolo, in entrambe le opzioni l'articolo deve essere fisicamente nella nostra sede centrale di Viladecans, il tempo per la risoluzione è un massimo di 30 giorni di calendario dalla ricezione.

Per inviare l'articolo difettoso, è necessario andare al sito [www.recambiosmarinos.es](http://www.recambiosmarinos.es), andare al tuo account e selezionare la GARANZIA all'interno del settore privato, da qui è possibile scaricare il file per la richiesta di garanzie di motori e parti e seguire le istruzioni.

**Recambios Marinos S.L.U.** non assumerà alcun prestito di sostituzione durante il processo di garanzia.

**Saranno accettate solo le garanzie correttamente elaborate dalla sezione di richiesta "elabora garanzia" dell'area clienti del nostro sito web ([www.recambiosmarinos.es](http://www.recambiosmarinos.es)). Eventuali richieste di informazioni relative alle garanzie effettuate tramite canali diversi, quali telefono, e-mail o riferimenti commerciali, non saranno prese in considerazione fino a quando la procedura non sarà stata completata correttamente dal sito web.**

### ESCLUSIONI DI GARANTÍA

**Recambios Marinos S.L.U.** non può essere accusato come responsabile del difetto di fronte a:

- Normale usura di un prodotto.
- Difetti di installazione o uso improprio.
- Installazione di un articolo non destinato a quel modello.
- Danni dovuti a cause esterne (incidente, fulmine, fluttuazione di corrente...)
- Difetti e conseguenze connesse al trasporto.
- Modifiche in impianti o barche destinati alla competizione.

In caso di rifiuto della garanzia, il cliente ha la possibilità di recuperare il suo articolo difettoso contattandoci via e richiesta di rimborso entro 7 giorni di calendario dalla data in cui viene informato del rifiuto della garanzia.

**Recambios Marinos S.L.U.** non fa parte delle garanzie commerciali annunciate a volte dai produttori.

**Non saranno accettati resi di materiale provenienti dalla sezione di gestione della garanzia del nostro sito web [www.recambiosmarinos.es](http://www.recambiosmarinos.es) il cui importo sia inferiore a 30 €.**

## REGOLE PER I RESI MERCE

**Recambios Marinos S.L.U.**, accetteranno i resi di merce se preventivamente autorizzati dalla Direzione. Si accetteranno i resi solo degli articoli che sono stati ordinati per errore.

Per errori del magazzino, del catalogo ecc. prego richiedere il modulo attraverso la mail [www.recambiosmarinos.es](mailto:www.recambiosmarinos.es), specificando il motivo.

Non si accetteranno resi di materiale il cui importo sia inferiore a € 30,00

### REQUISITI FORMALI:

La merce da restituire deve essere indicata in un documento di trasporto nel quale vanno trascritti, codici, quantità e descrizione e il riferimento della bolla originale di acquisto.

Il modulo per la richiesta di autorizzazione al reso lo potrà scaricare dal sito [www.recambiosmarinos.es](http://www.recambiosmarinos.es) e le verrà fornito un numero di pre-autorizzazione. Una volta compilato, il modulo dovrà essere inviato a [postventa@recmar.es](mailto:postventa@recmar.es), allegando copia della bolla. La mancanza dei requisiti descritti, il reso non potrà essere accettato e verrà restituito al mittente con l'addebito delle spese di trasporto.

**Una volta elaborato correttamente il reso, riceverai un'etichetta con il numero di registrazione che dovrà essere inserita nel pacco, opportunamente sigillato e con l'etichetta visibile, affinché il tuo pacco possa essere rintracciato presso le nostre strutture e la richiesta possa essere elaborata il prima possibile.**



DEVOLUCIÓN DE MATERIAL
EXPEDIENTE Nº:
<b>700486</b>
RMP1168196
<small>Por favor recorre esta hoja por la línea de puntos y pégalas en un lugar visible del exterior del paquete.</small>

### SCADENZE:

Il termine per la richiesta di autorizzazione al reso sarà di 30 giorni a partire dalla data di spedizione della merce e il tempo per la restituzione della merce sarà di 15 giorni a partire dalla data di pre-autorizzazione al reso comunicata dalla **Recambios Marinos S.L.U.**

### CONDIZIONI:

**Recambios Marinos S.L.U.**, non accetterà resi, qualunque sia il motivo per i seguenti articoli:

- Calzature
- Materiale elettrico
- Materiale su ordinazione extra catalogo
- Anodi, ancore, catene, tubi
- Articoli obsoleti o non più presenti a catalogo
- Eliche, gommoni, paddle surf e motori Parsun
- Olio, vernici, grasso, liquidi, inclusi tutti i prodotti di pulizia e manutenzione in generale.
- **Materiale elettrico**
- **Eliche**
- **Anodi**
- **Tubi flessibili**

### DANNI CASUSATI DURANTE IL TRASPORTO:

Si applicheranno le regole indicate dall'art. 366 del Codice del Commercio che recita: Il reclamo contro la Ditta di trasporti può essere fatto entro le ventiquattrore dalla ricezione della merce. Trascorso tale termine, non potrà essere fatto alcun reclamo.

Il materiale che viene spedito giornalmente dalla **Recambios Marinos S.L.U.** ai propri clienti, è controllato prima di essere impacchettato al fine di preservarne la sua integrità ed evitare danni durante il trasporto. Si prega di controllare sempre l'integrità delle scatole e nel caso in cui ci siano dei danni esteriori, si prega di accettare sempre con riserva e di firmare unitamente al corriere la copia della bolla di consegna e trattenere una copia. Una copia di tutto va poi inviata alla **Recambios Marinos S.L.U.** per poterla inoltrare alla Ditta di Trasporti corrispondente.

Tutti resi di materiale preventivamente autorizzato, dovranno essere spediti alla **Recambios Marinos S.L.U.** in porto franco entro i termini concordati includendo la copia della bolla e la richiesta di reso accettata.

**Entro ventiquattrore ore dal ricevimento della merce è possibile presentare reclamo alla ditta di trasporto incaricata.**

**Trascorsi i termini indicati o pagate le spese di spedizione, non sarà più accettato alcun reclamo nei confronti del corriere circa le condizioni in cui la merce è stata consegnata.**

### NOTE DI CREDITO:

**Recambios Marinos S.L.U.**, procederà alla emissione delle note di credito per tutti quei resi che abbiano i requisiti formali precedentemente indicati per il 90% del valore originario. Il restante 10% verrà trattenuto a copertura dei costi di movimentazione, imballaggio, controllo qualità etc.

### RISERVA DI PROPRIETÀ:

**Recambios Marinos S.L.U.** si riserva il diritto di proprietà di tutto il materiale venduto fino al pagamento totale delle relative fatture.

## GARANZIA LIMITATA DI RECAMBIOS MARINOS, S.L.

I prodotti forniti da **Recambios Marinos S.L.U.** sono garantiti contro i difetti di materiale o di lavorazione per un periodo di:

**3 anni dalla data di acquisto per prodotti del tutto NUOVI**

**1 anno per i RIGENERATI.**

**I prodotti utilizzati per finalità commerciali, il noleggio o uso aziendale, sono garantiti per un periodo di: 90 giorni.**

Solo saranno coperti dalla garanzia i clienti che possono fornire la prova di acquisto della Recambios Marinos.

**Recambios Marinos S.L.U.** non copre in garanzia e rimane al margine di eventuali errori di installazione che potrebbero causare il concessionario, il servizio meccanico o il cliente finale. Questa garanzia copre solo i difetti di fabbricazione ed esclude i seguenti casi:

- modifica, smontaggio di parti
- rettifiche
- la normale usura
- danni accidentali
- un'installazione difettosa o uso improprio
- abuso, negligenza
- mancanza di manutenzione
- l'uso di qualsiasi accessori o componenti non venduti dalla Recambios Marinos
- da benzina, olio e lubrificanti che non sono adatti a questo tipo di prodotto (non raccomandato).

La responsabilità di garanzia della Recambios Marinos sarà se l'articolo è danneggiato dalle:

- inondazioni
- incendi
- tempeste
- o elemento naturale climatico
- o se il numero di modello o altro tipo di identificazione è stato alterato, modificato o cancellato.

Recambios Marinos non sarà responsabile di tutte le spese per:

- **la manodopera**
- i servizi di carburante
- gru o rampe
- traino
- viaggio
- altri costi indiretti dovuti a causa di guasto del prodotto, un difetto dello stesso o di un termine ragionevole per correggere questo difetto.

**Questi concetti non sono coperti da questa garanzia.**

Recambios Marinos si riserva il diritto di ispezionare e determinare se la parte si è guastata a causa di un difetto di fabbricazione. Non smontare nessun pezzo. L'obbligo di Recambios Marinos è limitato a riparare, sostituire o rimborsare il prodotto una volta che è stato identificato come difettoso a sua unica discrezione. Si riserva altresì il diritto di pagare il prezzo di acquisto, piuttosto che riparare o sostituire il prodotto o qualsiasi componente. I pezzi sono coperti di garanzia solo per il suo periodo originale. Una volta che il periodo di garanzia è scaduto, la garanzia su tutte le parti soggette a manutenzione automaticamente scade. Recambios Marinos può tenersi i pezzi che consideri difettosi secondo la politica di garanzia.

Recambios Marinos non garantisce né si responsabilizza dell'uso o ai risultati di utilizzo del prodotto in termini di prestazioni, affidabilità, ecc. L'intero rischio come risultato e le prestazioni del prodotto, è a carico del cliente.

La responsabilità della Recambios Marinos verso il cliente per il compimento della garanzia, sarà limitata al prezzo di acquisto pagato per il prodotto.

Nessun rivenditore della Recambios Marinos, agente o dipendente è autorizzato ad apportare qualsiasi modifica o estensione di questa polizza di garanzia.

Processo:

- Deve comunicare alla Recambios Marinos qualsiasi difetto di prodotto che si trova dentro del periodo di garanzia alla Recambios Marinos per ottenere immediatamente l'impresso di sollecito di garanzia e un numero di RGA (numero di garanzia).
- Una volta Recambios Marinos ha ricevuto la richiesta di garanzia e il pezzo reclamato con il numero di file RGA e l'imballo originale Recambios Marinos procederà alla sua ispezione.
- Solo se il difetto entra in garanzia, il pezzo verrà riparato o sostituito, a discrezione della Recambios Marinos.
- In caso si richieda la riparazione, bisognerà inviare il prodotto alla Recambios Marinos utilizzando il nostro corriere prepagato con la prova di acquisto.
- Quando il materiale viene riparato, verrà rispedito all'indirizzo che avrà indicato. Il sistema di invio sarà determinato dalla Recambios Marinos.

È possibile contattare il nostro servizio tecnico della Recambios Marinos attraverso la mail:

**garantias@recmar.es postventa@recmar.es**

Tale garanzia comprende solo ed esclusivamente la garanzia relazionata con il prodotto che ha somministrato la Recambios Marinos. Altre garanzie o impegni assunti da qualsiasi altra persona non autorizzata, non sono vincolanti per la Recambios Marinos a meno di previa autorizzazione scritta.

## POLITIQUE DE GARANTIE RECMAR

Tous les produits vendus par **Recambios Marinos S.L.U.** doivent être installés et utilisés par du personnel compétent sous sa seule responsabilité.

**Recambios Marinos S.L.U.** n'est pas responsable des conséquences d'une installation défectueuse ou inappropriée de tout élément n'incluant pas les solutions d'installation.

L'installateur sera responsable de la vérification de l'application correcte des recommandations du fabricant concernant la compatibilité d'utilisation.

Les articles vendus par **Recambios Marinos S.L.U.** bénéficient de la garantie légale de conformité, conformément aux conditions énoncées dans le Décret-loi royal 7/2021, du 27 avril (ci-après, RDL 7/2021), portant approbation du texte consolidé de la loi générale de la défense des consommateurs et des utilisateurs.

Les articles vendus par **Recambios Marinos S.L.U.** ont une garantie limitée pour les défauts de fabrication, les périodes peuvent varier de 3 ans à 3 mois en fonction de l'application du produit et du type de navire où ils ont été installés (7ème / 6ème / 5ème liste), excluant les articles considérés comme des consommables, ampoules, produits électriques, batteries et autres.

Si vous ne connaissez pas la durée de garantie exacte du produit, contactez le service commercial.

Pour les dommages causés au cours du transport, les dispositions de l'article 366 du code de commerce seront appliquées, ce qui stipule:

Vingt-quatre heures maximum après la réception de la marchandise, une réclamation doit être adressée à la société de transport.

Après que les conditions aient été exprimées ou que le fret eu été payé, aucune réclamation ne sera acceptée contre le transporteur auprès de l'État.

Lorsque la marchandise a été livrée. Le matériel que nous envoyons quotidiennement de **Recambios Marinos S.L.U.** à nos clients est examiné avant l'emballage pour une intégrité parfaite et éviter les dommages de transport. N'oubliez pas qu'il est très important d'inspecter le chargement en présence du transporteur.

Lorsque des dommages sont constatés sur le colis, ils doivent figurer sur le bon de livraison du transporteur.

Une mention du type (EN FONCTION DE LA MARCHANDISE, SAUF INSPECTION), et doit être signé par vous et le transporteur, s'il est reçu défectueux le matériel doit être enregistré pour ces raisons à la fois par le transporteur et par **Recambios Marinos S.L.U.** pour qu'une réclamation soit faite la compagnie de transport correspondante.

### DEMANDE DE GARANTIE

La garantie sera toujours soumise à l'évaluation finale du service technique de **Recambios Marinos S.L.U.** Cette évaluation sera effectuée dans nos installations ou, si nécessaire, par le fabricant de l'article, dans les deux cas, l'article doit être physiquement dans nos locaux de Viladecans, le délai de résolution sera de 30 jours maximum à partir de sa réception.

Pour envoyer l'article défectueux, vous devez vous rendre sur le site [www.recambiosmarinos.es](http://www.recambiosmarinos.es), accéder à votre compte et sélectionner PIECES DE RETOUR.

Dans l'espace privé, vous pouvez télécharger le fichier pour demander des garanties de moteurs et de pièces et suivre les instructions.

Si tel est votre souhait, **Recambios Marinos S.L.U.** n'assumera aucun prêt de remplacement pendant le processus de garantie.

**Seules les garanties correctement traitées depuis la section de demande « processus de garantie » de l'espace client sur notre site Web [www.recambiosmarinos.es](http://www.recambiosmarinos.es) seront acceptées.**

**Toute demande de renseignements concernant les garanties formulée par différents canaux tels que le téléphone, le courrier électronique ou les références commerciales ne sera pas traitée tant que le processus n'aura pas été correctement effectué à partir du site Web.**

### EXCLUSIONS DE GARANTIE

**Recambios Marinos S.L.U.** ne sera pas responsable des défauts suivants:

- Usure normale d'un produit.
- Défauts d'installation ou d'utilisation inadéquate.
- Installation d'un article non destiné à ce modèle.
- Dommages dus à une cause externe (accident, foudre, fluctuation de courant...)
- Défauts et conséquences liés au transport.
- Modifications d'installations ou de bateaux destinés à la compétition.

En cas de refus de la garantie, le client a la possibilité de récupérer son article défectueux en nous contactant par courrier électronique pour demander le retour à ses frais de celui-ci dans les 7 jours calendaires suivant

la date à laquelle vous avez été informé du rejet de la garantie.

**Recambios Marinos S.L.U.** ne participe pas à des garanties commerciales parfois annoncées par les fabricants.

**Les retours de matériel de la section de traitement de garantie de notre site Web [www.recambiosmarinos.es](http://www.recambiosmarinos.es) ne seront pas acceptés, dont le montant est inférieur à 30 €.**

## RÈGLES POUR LE RETOUR DE PIÈCES EN STOCK

Afin d'aider nos clients à maintenir un stock correct, **Recambios Marinos S.L.U.** acceptera les retours des pièces commandées par erreur. Les retours de matériel dont le montant est inférieur à 30 € ne seront pas acceptés.

### EXIGENCES FORMELLES:

Le matériel à retourner doit être apparaître dans un bon de livraison ou une facture.

Ni le matériel ni l'emballage ne doivent présenter de dommage. Aucun retour ne sera accepté qui ne respecte aucun de ces points. Le remboursement sera traité dans l'espace privé à partir du site Web [www.recambiosmarinos.es](http://www.recambiosmarinos.es)

**Une fois le retour traité correctement, vous recevrez une étiquette avec le numéro d'enregistrement qui devra être inclus dans le colis, correctement scellé et avec l'étiquette visible, afin que votre colis puisse être localisé dans nos installations et que la demande puisse être traitée dans les plus brefs délais.**



DEVOLUCIÓN DE MATERIAL
EXPEDIENTE Nº:
<b>700486</b>
RMP1168196
<small>Por favor recorte esta hoja por la línea de puntos y péguela en un lugar visible del exterior del paquete.</small>

### DÉLAIS:

Le délai maximum pour demander le retour sera de 30 jours calendaires à compter de la date d'envoi de la marchandise de nos installations. La période pour le retour de la marchandise sera au maximum de 15 jours à compter de la date de réception du numéro d'autorisation de retour (vous serez informé automatiquement par **Recambios Marinos S.L.U.** au cours du processus de retour)

### CONDITIONS:

**Recambios Marinos S.L.U.**, n'acceptera en aucun cas le retour de ces articles:

- Chaussures.
- Matériel électrique.
- Matériel commandé sur demande.
- Anodes, ancres, chaîne, tuyaux.
- Les articles obsolètes ou abandonnés.
- Hélices, pneumatiques, blocs moteurs, Paddle, Surf et moteurs Parsun.
- Huiles, peintures, graisses, liquides, y compris les produits de nettoyage et d'entretien en général.
- **Matériel électrique**
- **Hélices**
- **Anodes**
- **Tuyaux**

### DOMMAGES CAUSÉS PAR LE TRANSPORT:

Les dispositions de l'article 366 du Code de commerce seront appliquées, qui stipule: «Dans les vingt-quatre heures après la réception de la marchandise, une réclamation doit être faite à la compagnie de transport assignée.

Une fois que les conditions ont été exprimées ou que le fret est payé, aucune réclamation ne sera acceptée contre le transporteur sur l'état dans lequel les marchandises ont été livrées.

Le matériel que nous envoyons chaque jour de **Recambios Marinos S.L.U.** à nos clients est examiné avant d'être emballé pour une intégrité parfaite et éviter les dommages de transport. Rappelez-vous qu'il est très important d'inspecter les colis en présence du transporteur. Lorsque des dommages sur le colis sont observés, vous devez noter une mention du type (selon la marchandise, sauf inspection), et doit être signé par vous et le transporteur, s'il est reçu défectueux le matériel doit être enregistré pour ces raisons à la fois par le transporteur et par **Recambios Marinos S.L.U.** pour qu'une réclamation soit faite la compagnie de transport correspondante.

Tous les retours de matériel préalablement autorisés seront envoyés à **Recambios Marinos S.L.U.** indiquant à l'endroit visible le numéro de retour.

**Dans les vingt-quatre heures suivant la réception de la marchandise, une réclamation peut être formulée auprès du transporteur mandaté.**

**Une fois les délais indiqués écoulés ou les frais de transport payés, aucune réclamation ne sera admise contre le transporteur quant à l'état dans lequel la marchandise a été livrée.**

### ABONNEMENTS:

**Recambios Marinos S.L.U.** procédera au paiement de toutes les déclarations (qui respectent chacune des conditions de forme, modalités et conditions) pour un montant égal à 90% de la facture originale. Les 10% restants seront destinés à supporter les coûts occasionnés par les retours (manutention, emballage, contrôle de qualité...).

### RESERVE DE PROPRIETE:

**Recambios Marinos S.L.U.** se réserve le droit de disposer de tout le matériel fourni jusqu'à concurrence du paiement intégral par l'acheteur, le transfert de leur propriété ne pouvant intervenir avant cette échéance.

## GARANTIE LIMITÉE DE RECAMBIOS MARINOS, S.L.U.

Les produits fournis par Recambios Marinos S.L.U. sont garantis contre tout défaut de matériel ou de fabrication pendant une période de :

**3 ans à compter de la date d'achat pour les produits NEUFS.**

**1 an pour les produits REBUILTÉS.**

**Les produits utilisés à des fins commerciales, locatives ou professionnelles sont garantis pendant une période de 90 jours.**

Dans tous les cas, il est indispensable de présenter la facture d'achat.

**Recambios Marinos S.L.U.** ne couvre pas la garantie et n'est pas responsable des erreurs d'installation qui peuvent être causées par le revendeur, le service technique, le mécanicien ou le client final. Cette garantie ne concerne que les défauts de fabrication et exclut les cas suivants :

- modification, démontage de pièces
- ajustements
- l'usure normale
- dommages causés par un accident
- installation défectueuse ou mauvaise manipulation
- mauvaise utilisation, négligence
- manque d'entretien
- l'utilisation d'un accessoire ou d'une pièce non vendue par Recambios Marinos
- l'utilisation d'essence, d'huiles ou de lubrifiants non adaptés à ce type de produit (déconseillés).

La responsabilité de Recambios Marinos en matière de garantie est annulée si la pièce est endommagée par :

- inondation
- incendie
- tempête
- tout autre élément météorologique naturel
- lorsque le numéro de modèle ou toute autre identification a été altéré, modifié ou oblitéré.

Recambios Marinos ne sera pas responsable des frais de :

- **la main-d'œuvre**
- le carburant
- les services de remorquage ou de rampe
- remorquage
- les déplacements
- autres coûts indirects résultant de la défaillance du produit, d'un défaut du produit ou d'un retard raisonnable dans la correction de ce défaut.

**Ces éléments ne sont pas couverts par la présente garantie.**

Recambios Marinos se réserve le droit d'inspecter et de déterminer si la pièce est défectueuse en raison d'un défaut de fabrication. Ne démontez aucune pièce. L'obligation de Recambios Marinos se limitera à réparer, remplacer ou créditer le produit une fois qu'il aura été identifié comme défectueux, à sa seule discrétion. Recambios Marinos se réserve également le droit de créditer le montant du prix d'achat, plutôt que de réparer ou de remplacer le produit ou toute partie de celui-ci.

Les pièces ne sont couvertes par cette garantie que pendant la période de garantie initiale. Une fois la période de garantie expirée, la garantie sur les pièces réparées ou remplacées expire également. Recambios Marinos peut conserver les pièces qu'il considère comme défectueuses.

Recambios Marinos ne garantit pas et n'est pas responsable de l'utilisation ou du résultat de l'utilisation du produit en termes de performance, de fiabilité, etc. L'intégralité du risque lié au résultat et à la performance du produit est assumée par le client.

La responsabilité pour l'exécution de la garantie est limitée au prix d'achat payé pour le produit.

Aucun revendeur, agent ou employé de Recambios Marinos n'est pas autorisé à étendre ou à modifier cette politique de garantie.

Procédure :

- Recambios Marinos doit être informé de tout défaut du produit qui entre dans la période de garantie afin d'obtenir immédiatement le formulaire de demande de garantie et un numéro RGA (dossier de garantie).
- Une fois que Recambios Marinos a reçu la demande de garantie et la pièce réclamée avec le numéro de dossier, marqué sur l'emballage de la pièce, il procédera à son examen.
- Si le défaut est couvert par la garantie, la pièce sera réparée ou remplacée.
- Si une réparation est nécessaire, le produit doit être envoyé à Recambios Marinos en port payé avec la preuve d'achat.
- Une fois la pièce réparée, elle sera renvoyée par le système d'expédition déterminé par Recambios Marinos.

Vous pouvez contacter le service technique de Recambios Marinos à l'adresse suivante

**garantias@recmar.es postventa@recmar.es**

Cette garantie couvre uniquement et exclusivement la garantie liée au produit qui vous a été fourni par Recambios Marinos. Les autres garanties ou engagements pris par une personne non autorisée ne sont pas contraignants pour Recambios Marinos, sauf autorisation écrite préalable.



## BARCELONA

Jocelyn Bell, 26  
08840 Viladecans (Barcelona)  
Tel. 900 841 013 - 93 633 34 80  
Fax 93 662 66 59

International  
phone: (+34) 93 662 66 55  
Fax (+34) 93 662 66 59

info@recambiosmarinos.es  
www.recambiosmarinos.es

## GIRONA

C/ Gironés, 5  
Pol. Ind. El Plà  
17486 Castelló d'Empúries (Girona)  
Tel. (+34) 972 158 809

girona@recmar.es

## CANARIAS

Laura Grote de la Puerta, 3, Nave 5  
Pol. Industrial El Mayorazgo  
38110 Santa Cruz de Tenerife  
Tel. (+34) 922 621 499

canarias@recmar.es



1917 NW 79 Ave  
Miami, FL 33126

Ph. 786-962-5020

info@usarecmar.com  
www.usarecmar.com

[www.recambiosmarinos.es](http://www.recambiosmarinos.es)

[www.usarecmar.com](http://www.usarecmar.com)