



Personal floatation device complying with EN ISO 12402 standards



▲22.458.03

▲22.458.02

ITALIA 7 basic lifejacket - 100N (EN ISO 12402-4)

Orange colour, soft foam, quick release buckle, compact structure for better stowage. Whistle and reflective tapes included.

Code	Colour	Size
22.458.02	orange	Adults (over 40 kg)
22.458.03	orange	Junior (15 to 40 kg)



Bag for lifejackets

Clear PVC bag for 4 lifejackets 100N (type 22.458.02). Transpirable net for ventilation.

Code	cm
22.409.30	38x30x31 h

OSCOLATI



▲22.465.01/02

▲22.465.03/04/05/06/07



Isabel lifejacket 100N (EN 12402-4)

Certified in compliance with the new UE 2016/425 standards. Made from high visibility fabric and soft foam. Fitted with type-tested whistle and reflective tapes. High strap + reflective tapes with snap buckle. Ergonomic collar.

Code	Colour	Size	Type
22.465.01	orange	To 15 kg Baby XXS	With knickers
22.465.02	orange	From 15 to 30 kg Baby XS	With knickers
22.465.03	orange	From 30 to 40 kg S	-
22.465.04	orange	From 40 to 50 kg M	-
22.465.05	orange	From 50 to 60 kg L	-
22.465.06	orange	From 60 to 70 kg XL	-
22.465.07	orange	Over 70 kg XXL	-

OSCOLATI



SV-100 lifejacket - 100N (EN ISO 12402-4). Top Quality model

Soft foam, front zip, quick release buckle, Whistle and reflective tapes included. Modular collar for better protection of the head.

Code	Colour	Size	Type
22.483.45	orange	Kids up to 15 kg	With thigh strap
22.483.60	orange	Kids 15 to 30 kg	With thigh strap



FLORIDA 7 basic lifejacket - 150N (EN ISO 12402-3)

Soft foam, quick release buckle, compact structure for better stowage.

Code	Colour	Size
22.459.02	Orange	Adults (over 40 kg)
22.459.03	Orange	Junior (30-50 kg)



Aurora lifejacket 150N (EN 12402-3)

Certified in compliance with the new UE 2016/425 standards.
 Made from high visibility fabric and soft foam.
 Fitted with type-tested whistle and reflective tapes.
 Thigh strap + reflective tapes with snap buckle. Ergonomic collar.

Code	Colour	Size	Type
22.466.01	Orange	Up to 20 kg Baby XXS	With knickers
22.466.02	Orange	20 to 30 kg Baby XS	With knickers
22.466.03	Orange	30 to 40 kg S	-
22.466.04	Orange	40 to 50 kg M	-
22.466.05	Orange	50 to 60 kg L	-
22.466.06	Orange	60 to 70 kg XL	-
22.466.07	Orange	Over 70 kg XXL	-

OSCOLATI



SV-150 lifejacket - 150N (EN ISO 12402-3). Top Quality model.

Soft foam, front zip. Whistle and reflective tapes included.
 Modular collar for better protection of the head.

Code	Colour	Size	Type
22.482.45	orange	Kids up to 15 kg	with pants
22.482.60	orange	Kids 15 to 30 kg	with pants

OSCOLATI



Aqua Sailor buoyancy aid - 50N (EN ISO 12402-5)

Ideal for use on sailboats and canoes.
 Soft foam, folding bottom for better comfort when sitting.

Code	Colour	Size
22.476.01	yellow/blue	25 to 40 kg Junior
22.476.02	yellow/blue	40 to 60 kg S
22.476.03	yellow/blue	over 60 kg M/L
22.476.04	yellow/blue	over 70 kg XL

OSCOLATI



Dominator Ski buoyancy aid - 50N (EN ISO 12402-5)

Soft foam, fluo colours, perfect fit.

Fluo yellow/black	Fluo red/black	Size
22.473.01	22.474.01	25 to 40 kg Junior
22.473.02	22.474.02	40 to 60 kg S
22.473.03	22.474.03	Over 60 kg M/L
22.473.04	22.474.04	Over 70 kg XL

OSCOLATI



Canoe buoyancy aid - 50N (EN ISO 12402-5)

Specific for canoes, it allows free movements, technical product.

Code	Colour	Size
22.492.00	red	One size fits all adults

OSCOLATI





Self-inflatable personal floatation devices complying with EN ISO 12402-3 standards

OSCOLATI



Fun self-inflatable lifejacket 150 N (EN ISO 12402-3)

Lifejacket for adults (minimum 40 kg).

Code	Activation	Colour	Size	Bottle + spare valve
22.398.12	Manual	 Red	One size fits all - adult	22.401.10
22.398.13*	Automatic	 Blue	One size fits all - adult	22.398.14

* UML activator - 33-g bottles



OSCOLATI



SAIL self-inflatable lifejacket - 150 N (EN ISO 12402-3)

Fitted with safety harness complying with ISO 12401 standards. Model for adults with thigh strap.

Code	Activation	Colour	Bottle + spare valve
22.396.04	Automatic	 Red	22.398.14

UML activator - 33-g bombs



OSCOLATI



Security self-inflatable lifejacket with HAMMAR hydrostatic inflation - 150 N (EN ISO 12402-3)

Fitted with safety harness complying with ISO 12401 standards. The HAMMAR MA1 hydrostatic automatic inflator prevents the jacket from unwanted inflation, as it happens with traditional inflating systems that activate when coming into contact with water. The HAMMAR system activates only with hydrostatic pressure (immersion of at least 15 cm in water). Model for adults with thigh strap.

Code	Activation	Colour	Bottle + Hammar MA1
22.395.00	Hammar automatic	 Red	22.395.10

Hammar activator - 33-g bomb



OSCOLATI



Professional self-inflatable lifejacket 180N (EN ISO 12402-3)

180N buoyancy (20% more than the standards). Ergonomic shape with collar. Buckles with quick release and adjustment. 2 thigh straps. Double connection for safety harnesses in compliance with ISO 12401 standards. Automatic or manual activation, with clear window to check the device correct fastening. Model for adults.

Code	Colour	Bottle + spare valve	
		for lifebuoys made up to 04/19	for lifebuoys made from 05/19
22.397.00	 Black	22.397.10	22.397.11



Sail Pro self-inflating lifejacket - 180N (EN ISO 12402-3)

Hammar hydrostatic automatic self-inflation (avoiding all possibility of unwanted automatic inflation). Integrated safety harness complying with ISO 12401 standards.
 25% more compact than traditional self-inflating lifejackets, easier movements.
 Bag with automatic zip closure: lighter, more compact, faster opening and closing than with hook&loop fastener.
 With thigh strap.

Code	Activation	Outside colour
22.394.00	Hammar automatic	Black

- # 22.394.10 Fluo water/wind spray hood *OPTIONAL*.
 22.395.11 38-g spray can + Hammar MA1
 22.409.23 Automatic electronic signaller.



▲ 22.394.10



▲ 22.394.00

Premium self-inflatable lifejacket - 300 N (EN ISO 12402-2)

Designed for the toughest conditions, 300N buoyancy for utmost safety even when wearing boots, waterproof garments, etc. and allowing a very fast body rotation. HAMMAR hydrostatic activation that prevents unwanted inflation (possible with traditional activation systems). *OPTIONAL* ISO 12402-8 Fluo spray hood (22.394.10). Safety harness **complying with ISO 12401 standards**. Comfortable padded collar. Fitted with thigh strap.

Code	Activation	Colour	Spare bottle (60 g) + HAMMAR MA1 valve
22.393.00	HAMMAR automatic	Black	22.393.01

- # 22.394.10 Water-/wind spray hood
 22.409.23 Automatic electronic signaller.



▲ 22.394.10



▲ 22.393.00

Baby self-inflatable lifejacket - 150 N (EN ISO 12402-3)

For children over 15 kg. Fitted with thigh strap and safety harness complying with ISO 12401 standards.

Code	Activation	Colour	Bottle + spare valve
22.399.01	Automatic	Red	22.399.15

UML activator - 24-g bottles

**New Junior self-inflatable lifejacket 1MAJ 150 N (EN ISO 12402-3)**

For children over 15 kg, fitted with thigh strap.
 Neck made of soft elastic fabric for optimum comfort.

Code	Activation	Colour	Size	Canister + spare valve
22.299.01	Automatic	Red-Blue	Junior	22.399.15



OSCOLATI

**New****Self-inflatable lifejacket MK150 - 150 N (EN ISO 12402-3)**

Lifejacket for adults.
UML-5 activator. Neck made of soft elastic fabric for optimum comfort.

Code	Activation	Colour	Size	Canister + spare valve
22.298.12	Manual	Red - Black	One fits all - adult	22.401.10
22.298.13	Automatic	Blue - Black	One fits all - adult	22.398.14



OSCOLATI

**New****Self-inflatable lifejacket 1MAD 150 N (EN ISO 12402-3)**

Fitted with type-tested safety harness.
UML-5 activator. Neck made of soft elastic fabric for optimum comfort.

Code	Activation	Colour	Size	Canister + spare valve
22.296.04	Automatic	Red	One fits all - adult	22.398.14



OSCOLATI

**New****Professional self-inflatable lifejacket 275MA - 275 N (EN ISO 12402-2)**

Fitted with type-tested safety harness.
UML-5 activator. Neck made of soft elastic fabric for optimum comfort.

Code	Activation	Colour	Size
22.293.00	Automatic	Blue	One-size - adult

**Service kit for self-inflatable lifejackets**

Bottle and universal spare valve kit for self-inflatable lifejackets

Code	Bottle	Activation	Use
22.401.10	33 g	no	150 newton manual
22.398.14	33 g	UML-5	150 newton automatic
22.395.10	33 g	HAMMAR	150 newton automatic
22.397.10	38 g	UML-5	180 newton automatic
22.397.11	38 g	UML Pro Sensor Elite	180 newton automatic
22.399.15	24 g	UML-5	Baby automatic
22.395.11	38 g	HAMMAR	180 newton automatic
22.397.60	60 g	UML-5	MOB, Dan buoy, etc.

Self-inflatable lifejacket - MK150

22.298.12/13 - Soft elastic fabric for optimum comfort



MED-approved lifejackets



WORLDLIFE 8 MED-approved lifejacket, IMO resolution MSC.200(80)

RINA-approved for merchant navy.
Made in compliance with the new IMO MSC.200(80) regulations.

Code	Colour	Size	Type
22.411.01	red	over 40 kg	adults
22.411.02	red	16 to 43 kg	youths
22.411.03	red	up to 15 kg	kids



MED (Marine Equipment Directive) type-tested ring lifebuoys / Italian Ministerial Decree 385/99

OSCOLATI



MED-approved ring lifebuoy

Made of **orange Eltex** filled with polyurethane foam. Fitted with reflective tapes.
RINA-approved for merchant boats within and beyond the straits. **It conforms to Ministerial Decree 385/99 for pleasure boating.**

Code	Ø cm	OPTIONAL cover
22.407.00	40x60	22.406.87; 22.406.88; 22.406.89



OSCOLATI



Cover for ring lifebuoys 22.407.00

UV RESISTANT Padded double-layer polyurethane-coated fabric. Fitted with adjustable straps for mounting on the pulpit. Zip closure. Floating rescue light (30.584/583.00) + type-approved rope 22.408.06 can be stowed inside the straps.

White	Blue	Grey	For lifebuoy
22.406.88	22.406.89	22.406.87	22.407.00



Ring lifebuoy (it conforms to the old Ministerial Decree 20/4/78)



Code	Description
22.407.02	Made of orange Eltex , filled with polyurethane foam, 35x60 cm Ø.



22.407.11 *Optional rear reflective tapes.*

Reflective tape kit



Code	Length	For lifebuoys
22.407.11	40 cm each	22.407.02

MED-approved ring lifebuoy

RINA-certified for merchant ships within and beyond straits, and for pleasure boats in compliance with the Italian Ministerial Decree 385/99.

Code	Version	Ø cm
22.407.04	traditional	45x75

**OSCULATI****Ring lifebuoy**

For pleasure boats in compliance with the Italian Ministerial Decree D.M. 385/99.

Code	Version	Ø cm	OPTIONAL ring lifebuoy strings	OPTIONAL floating rescue light
22.439.01	Super-compact	40x64	-	-
22.439.02	Super-compact with rescue light housing	40x64	22.434.02	30.432.00

**OSCULATI****Ring lifebuoy accessories**

Nylon straps with hook&loop fastener, housing for Sealux floating rescue light 30.432.00. Fitted with clamp 37.175.81 for fixing on tube.

Code	For ring lifebuoys
22.434.02	22.439.02

**SEALUX electronic floating rescue light**

It automatically activates when it touches water but it doesn't when wet with rain, no matter in which position it is kept.

Approved for pleasure boating (Ministerial Decree 385/99).

No batteries supplied.

Code	↔ mm
30.432.00	124x72x107,5 h

OSCULATI**Ring lifebuoy with accessories**

Fitted with Sealux floating rescue light 30.432.00, holding strap and type-approved rope for up to 400kg.

Code	Version	With lifejacket	Ø cm
22.439.03	Super-compact	22.439.02	40x64



Horseshoe lifebuoys

OSCULATI



Horseshoe lifebuoy conforming to Ministerial Decree 385/99

Made of orange polyethylene filled with polyurethane foam. It conforms to Ministerial Decree 385/99 for pleasure boating.

Code	Ø cm	OPTIONAL ABS case	OPTIONAL support
22.420.00	35x60	22.420.02	22.418.01

OSCULATI



Horseshoe lifebuoy supplied with accessories conforming to Ministerial Decree 385/99

White ABS case to be hung to the pulpit or on the bulkhead. Quick opening.

Code	Description
22.420.01	Lifebuoy 22.420.00 + floating rescue light 30.584.00 + rope 22.408.06 all fitted into a white ABS case designed to be hung to the pushpit or to the bulkhead. Quick opening; for pulpit mounting order 4 clamps models 37.175.81 or 37.261.01 or 37.264.02
22.420.02	White ABS case, only

OSCULATI



Bag for horseshoe lifebuoys 22.420.00

UV RESISTANT Padded double-layer polyurethane-coated fabric. Fitted with adjustable straps for mounting on the pulpit. Zip closure. Floating rescue light (30.584/583.00) + type-approved rope 22.408.06 can be stowed inside the straps.

White	Blue	Grey	For lifejacket
22.430.04	22.430.05	22.430.06	22.420.00



OSCULATI



Soft horseshoe lifebuoy

Made of soft ethafoam with a sturdy UV-resistant and waterproof polyester fabric cover that can be removed for washing.

Code	Colour	cm	OPTIONAL				
			White fabric cover	Blue fabric cover	Grey fabric cover	Bracket	Floating rescue light
22.416.00	White	50x50x10	22.424.31	22.424.32	22.424.33	22.418.00	30.583.00
22.416.01	Yellow	50x50x10	22.424.31	22.424.32	22.424.33	22.418.00	30.583.00
22.416.02	Orange	50x50x10	22.424.31	22.424.32	22.424.33	22.418.00	30.583.00

OSCULATI



Horseshoe lifebuoy kit with bracket for tubes

Lifebuoy made of soft foam 22.416.xx, stainless steel bracket 22.418.00 and floating rescue light 30.583.00.

Code	Colour
22.419.00	White
22.419.01	Yellow
22.419.02	Orange



Horseshoe lifebuoy 22.416.02 with fabric cover

Supplied with floating rescue light **30.583.00** and type-approved rope for up to 400 kg **22.408.06**, all fitted into a **PVC/polyester** fabric cover **22.424.3x** with a hook&loop fastener. It can be fastened to the pulpit using adjustable straps.

Code	Cover colour	Lifebuoy colour
22.424.01	White	Orange
22.424.02	Blue	Orange
22.424.03	Grey	Orange



OSCULATI



Cover for item number 22.416.xx

UV RESISTANT Cover made of **PVC/polyester fabric**. This elegant cover protects the lifebuoy and the floating rescue light against severe weather conditions and is ideal for tidy stowage.

Code	Description	Colour
22.424.31	Only cover	White
22.424.32	Only cover	Blue
22.424.33	Only cover	Grey



Brackets for personal rescue devices

Brackets for horseshoe lifebuoys

Made of **stainless steel** with bracket for floating rescue light (30.584.01). For 20- to 25-mm Ø tubes

Code	For lifebuoys
22.418.00	22.416.00; 22.416.01; 22.416.02 or similar
22.418.01	22.420.00

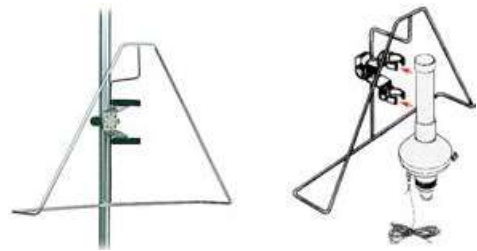

Universal bracket for lifebuoys

Made of epoxy-powder coated aluminium with ribbon. For 22/25-mm Ø tubes or bulkhead mounting.

Code	For lifebuoys
22.271.30	ring lifebuoys
22.371.35	horseshoe lifebuoys



Adjustable bracket for ring lifebuoys and installation kit

Code	Description
22.428.01	Adjustable SS bracket, bulkhead mounting, designed to hang ring lifebuoys of any size and their type-approved rope.
22.428.03	Square bracket designed for installation of floating rescue light 30.584.01 on item 22.428.01.

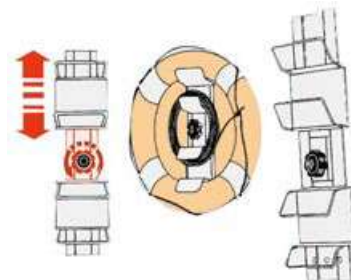

Telescopic bracket for ring lifebuoys

Made of **polished stainless steel**. Designed for bulkhead mounting or for fitting on the pulpit (20/22-mm tubes) with special clamps. **Ring lifebuoy + floating rescue light 30.583.00 + rope 22.408.06** can be stowed on the bracket.

Code	For life-buoys Ø	OPTIONAL floating rescue light holder*
22.427.00	600 to 660 mm	30.584.01

* Necessary only when using floating rescue light 30.584.00 ; not necessary with floating rescue light 30.583.00.



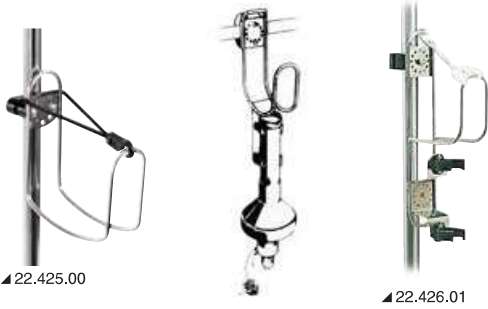

Stainless steel bracket for ring lifebuoys

For ring or horseshoe buoys. **Universal** model. It can be mounted on the deck, on the bulkhead or on 22/25-mm Ø stainless steel tubes, either straight or sloped by means of a special rotating nylon clamp. Fitted with **elastic lock**. **Standard** or **accessorized** version for floating rescue light 30,584,01.

Code	Type
22.425.00	Back for ring lifebuoys
22.426.01	Back for ring lifebuoys + floating rescue light holder (30,584,00; 30,582,00)

Levilene floating rope



Spliced, suitable for ring buoys. Snap-hook included.

Code	Ø mm	Length m
22.407.05	6	30

Levilene floating rope for ring lifebuoys



Code	Ø mm	Length m	Type-approved	Breaking load	Colour	Stainless snap hook INCLUDED
22.408.06	8	30	yes	400	orange	-
22.408.07	8	30	yes	400	white	09,247,70



Lifeguard emergency personal floatation device

Made of polyethylene and stuffed with polyurethane foam. Fitted with shoulder strap and towing line.



Code	mm	kg
22.407.20	670x230x135	1,4

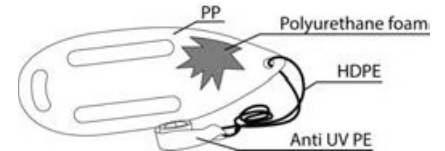
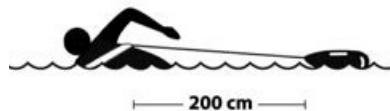

Rope and rack



Code	Description
22.408.08	Levilene throw lifeline to retrieve men over board. Fitted with end eyelet for holding the line. The line has to be tied to the guardrail on one end. It comes in a Fluo colour bag, 28 metres long, 5-mm Ø.
22.408.09	Stainless steel rack for lines 22,408,08 fitted with 22/25-mm Ø pole clamp.

Bracket for ring lifebuoys



Designed for use on the beach, in swimming pools, etc. It adapts to any ring lifebuoy on the catalogue.

Code	Description	section mm
22.429.01	Universal life buoy support	
22.429.02	160-mm high galvanized steel pole	40x60

Ring life buoy and line not included.

Line reel for bathing establishments



It can wind up 400 m of 8-mm Ø line. Made of stainless steel + anodized aluminium.

Code	mm
22.408.00	600x440x830h

Other personal floatation devices, MOB and accessories

MARSUPIO navigation kit

Kit for navigation within 3 to 12 miles for 4/6 persons. It comes in a bag that can also be used as a soft pillow.



In case the vessel is not CE-approved, it requires an additional bailer or exhaustion pump



22.409.33 Empty bag for 22.411.32; 22.411.40 Marsupio 4 (for 100 N belts)

22.409.35 Empty bag for 22.411.34; 22.411.41 Marsupio 6 (for 100 N belts)

22.409.37 Empty bag for 22.411.43 Marsupio 4/12 miles (for 150 N belts)

OSCULATI



Code	Version	Type	Type-approved within a	The kit contains									
				No of CE lifejackets	Extinguisher	Italian flag	Anchor line	Grapnel anchor	Distress signals	Line for ring lifebuoys	Boat hook	Horn	Floating rescue light
22.411.32*	With flares	Marsupio 4/3	3 miles	4 x 22.458.02 ISO 12402-4	31.450,00	35.459,01	01.106,00	01.139,25	1 package 30.230.01	22.408,06	34.171.40NE	21.462,30	-
22.411.40*	With flares	Marsupio 4/6	6 miles	4 x 22.458.02 ISO 12402-4	31.450,00	35.459,01	01.106,00	01.139,25	1 package 30.230.02	22.408,06	34.171.40NE	21.462,30	30.583,00; 30.584,00
22.411.34*	With flares	Marsupio 6/3	3 miles	6 x 22.458.02 ISO 12402-4	31.450,00	35.459,01	01.106,00	01.139,04	1 package 30.230.01	22.408,06	34.171.40NE	21.462,30	-
22.411.41*	With flares	Marsupio 6/6	6 miles	6 x 22.458.02 ISO 12402-4	31.450,00	35.459,01	01.106,00	01.139,04	1 package 30.230.02	22.408,06	34.171.40NE	21.462,30	30.583,00; 30.584,00
22.411.43*	With flares	Marsupio 4/12	12 miles	4 x 22.459.02 ISO 12402-3	31.450,00	35.459,02	01.106,00	01.139,04	1 package 30.230.02	22.408,06	34.171.40NE	21.462,30	30.583,00; 30.584,00
22.412.32	Without flares	Marsupio 4/3	3 miles	4 x 22.458.02 ISO 12402-4	31.450,00	35.459,01	01.106,00	01.139,25	-	22.408,06	34.171.40NE	21.462,30	-
22.412.40	Without flares	Marsupio 4/6	6 miles	4 x 22.458.02 ISO 12402-4	31.450,00	35.459,01	01.106,00	01.139,25	-	22.408,06	34.171.40NE	21.462,30	30.583,00; 30.584,00
22.412.34	Without flares	Marsupio 6/3	3 miles	6 x 22.458.02 ISO 12402-4	31.450,00	35.459,01	01.106,00	01.139,04	-	22.408,06	34.171.40NE	21.462,30	-
22.412.41	Without flares	Marsupio 6/6	6 miles	6 x 22.458.02 ISO 12402-4	31.450,00	35.459,01	01.106,00	01.139,04	-	22.408,06	34.171.40NE	21.462,30	30.583,00; 30.584,00
22.412.43	Without flares	Marsupio 4/12	12 miles	4 x 22.459.02 ISO 12402-3	31.450,00	35.459,02	01.106,00	01.139,04	-	22.408,06	34.171.40NE	21.462,30	30.583,00; 30.584,00

Man Over Board

It comes in a bag with a floating levilene line (22.408.06). To be fastened to the pulpit, it contains a buoyancy aid to be used in case of emergency. Smaller and more convenient than horseshoe lifebuoys.

Code	↔ mm
22.423.00	460x400x110



OSCULATI



DAN BUOY self-inflatable MOB system

Rescue system packed into a rugged ABS box. In case of man over board, open the box hung to the pulpit for instant deployment and throw it into the water. The man over board will find an inflated rescue device as well as a highly visible pole and light.

It includes: ring lifebuoy and built-in 260-cm pole, floating anchor, emergency light, reflective tape, weight and streaming ribbon.

Code	Floatability N	↔ mm	For hose Ø mm	kg	Spare kit
22.422.00	275	290x230x125	25	4,8	22,397,60





Automatic electronic signalling device for lifejackets

CE MED approved. Automatic lighting when it comes into contact with water. Modes: fast flash, fixed light, SOS, OFF.

Code	Activation	mm
22.409.23	Automatic in contact with water	62x28x31.5

MED-approved reflective tape

Designed for liferafts of fishing or commercial vessels. Available in 50-meter rolls.



Code	Type	For	Height mm	mm
22.300.02	to be sewn	lifejackets	50	50
22.300.03	self-adhesive	liferafts, ring lifebuoys, etc.	50	45.7

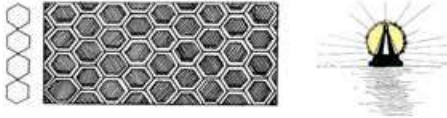

Pet Vest lifejacket for cats and dogs

Made of sturdy nylon/fabric, with soft foam padding for the animal's comfort. Fitted with rescue handle on the back.

Code	Size
22.404.50	up to 4 kg
22.404.51	3-6 kg
22.404.52	5-10 kg
22.404.53	9-18 kg
22.404.54	18-36 kg
22.404.55	over 35 kg



Emergency plugs

Cone-shaped wooden emergency plugs

Code	Package	Ø mm
22.803.80	Series of 10 plugs	8 to 38
22.803.81	Series of 9 plugs	20 to 49

Liferafts



FRANCIA liferaft complying with ISO 9650 standards

These liferafts are approved by the Marine Marchande Française and comply with the regulation "Division 333-2/310-1. Overhaul every three years. "Europe offshore" 1+24 hour version with full survival equipment.

Code	Seats	Container	cm	kg
22.712.06*	6	stiff case	73x47x34H	61
22.712.08	8	stiff case	73x47x36H	71
22.712.10	10	stiff case	85x60x31H	84
22.712.12*	12	stiff case	85x60x32H	95
22.713.06*	6	soft bag	73x32x43H	58
22.713.08	8	soft bag	78x38x49H	67
22.713.10*	10	soft bag	76x38x56H	79

Indicative sizes for liferafts in soft bag



"Med-Sea" professional self-inflatable liferaft

Type-approved by the Italian Ministry of Transport and Infrastructures according to the Ministerial Memorandum No. 78 dated 29/12/2008. Approved for fishing vessels not exceeding 24 metres sailing in the Italian waters and authorized for close coastal fishing (max 40 miles from the coastline).

Code	Seats	Container	cm	kg
22.750.06*	6	rectangular ABS	74x47x31	49
22.750.08	8	rectangular ABS	74x47x31	55
22.750.10	10	cylindrical VTR	118x56	73
22.750.12*	12	cylindrical VTR	118x56	76

Coastlight liferaft

Coastlife self-inflatable liferaft for navigation up to 12 miles offshore. It conforms to Ministerial Decree 29/07/2008 + Management Decree 02/03/2009, 1st overhaul after 3 years from the 1st packing, then every 2 years.

Code	Seats	Bag	← → cm	kg
22.704.04	4	Soft bag	66x28x27	25
22.704.06	6	Soft bag	66x26x28	25
22.704.08	8	Soft bag	64x30x33	30
22.704.10	10	Soft bag	65x29x35	39
22.704.12	12	Soft bag	68x29x35	44

Indicative sizes for liferafts in soft case



Oceanlife liferaft - approved for Italy

For navigation over 12 miles. Made in compliance with ISO 9650 standards, it conforms to Ministerial Decree 12/8/2002 and 832/2004 dated 10/3/2003. 2-year overhaul. Version in stiff case or soft bag.

Code	Seats	Container	← → cm	kg
22.725.04*	4	Stiff case	73x47x30	47
22.725.06	6	Stiff case	73x47x30	50
22.725.08	8	Stiff case	74x46x34	59
22.725.10	10	Stiff case	85x60x31	84
22.725.12*	12	Stiff case	85x60x32	95
22.720.04*	4	Soft bag	70x30x43	43
22.720.06	6	Soft bag	70x30x43	43
22.720.08	8	Soft bag	73x37x44	55
22.720.10*	10	Soft bag	76x38x56	79

Indicative sizes for liferafts in soft bag



Oceanlife liferaft + GB - Italy approval with GRAB BAG

For navigation over 12 miles. It conforms to ISO 9650 standards and to Ministerial Decree 12/8/2002 and 832/2004 dated 10/3/2003. 2-year overhaul. Version with separate equipment bag.

Code	Seats	Bag	← → cm	kg	Grab Bag	
					← → cm	kg
22.740.04*	4	Soft fabric bag	64x27x40	33	45x32	9
22.740.06	6	Soft fabric bag	64x27x40	34	45x32	13
22.740.08	8	Soft fabric bag	65x32x39	40	50x32	16

Indicative dimensions for liferafts in soft bag



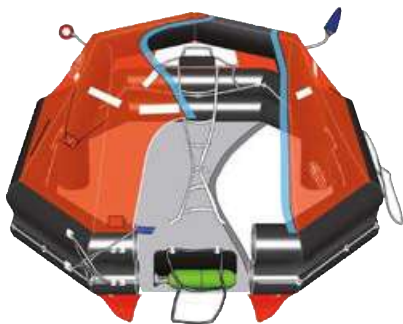

Deep-Sea Compact professional self-inflatable liferaft - Solas MED

In compliance with the Solas '74 standard. Very compact and refined design. It can be installed on any vessel provided it is stowed at a height not exceeding 18 metres.

POSTI	A PACK					B PACK				
	6	8	10	12	-	6	8	10	12	
Floating ring	1	1	1	1	-	1	1	1	1	
Knife	1	1	1	1	-	1	1	1	1	
Clasp knife	1	1	1	1	-	1	1	1	1	
Floating bailer	1	1	1	1	-	1	1	1	1	
Sponges	2	2	2	2	-	2	2	2	2	
Anchor	1+1	1+1	1+1	1+1	-	1+1	1+1	1+1	1+1	
Paddles	2	2	2	2	-	2	2	2	2	
Tin opener	3	3	3	3	-	--	--	--	--	
First aid kit case	1	1	1	1	-	1	1	1	1	
Whistle	1	1	1	1	-	1	1	1	1	
Parachute flare	4	4	4	4	-	2	2	2	2	
Hand-held flare	6	6	6	6	-	3	3	3	3	
Floating smoke signal	2	2	2	2	-	1	1	1	1	
Torch	1	1	1	1	-	1	1	1	1	
Radar reflector	1	1	1	1	-	1	1	1	1	
Mirror signal heliograph	1	1	1	1	-	1	1	1	1	
Signal table	1	1	1	1	-	1	1	1	1	
Fishing kit	1	1	1	1	-	--	--	--	--	
Food portion (package)	6	8	10	12	-	--	--	--	--	
Water (litres)	9	12	15	18	-	--	--	--	--	
Measuring glass	1	1	1	1	-	--	--	--	--	
Seasickness pills	36	48	60	72	-	36	48	60	72	
Seasickness bag	6	8	10	12	-	6	8	10	12	
Survival instructions	1	1	1	1	-	1	1	1	1	
Urgent measures	1	1	1	1	-	1	1	1	1	
Thermal blanket	2	2	2	2	-	2	2	2	2	
Repair kit	1	1	1	1	-	1	1	1	1	
Inflator	1	1	1	1	-	1	1	1	1	

Code	Seats	Bag	cm	kg
22.751.06	6	"A" pack - Roll	118x56x53	73
22.751.16	6	"A" pack - Flat	74x37x49	63.5
22.751.26*	6	"B" pack - Roll	118x56x53	58
22.751.36	6	"B" pack - Flat	74x37x49	52
22.751.08	8	"A" pack - Roll	118x56x53	81
22.751.18	8	"A" pack - Flat	86x61x35	77
22.751.28	8	"B" pack - Roll	118x56x53	70
22.751.38	8	"B" pack - Flat	86x61x35	58
22.751.10	10	"A" pack - Roll	118x56x53	91
22.751.20	10	"A" pack - Flat	86x61x35	90
22.751.30	10	"B" pack - Roll	118x56x53	67
22.751.40	10	"B" pack - Flat	86x61x35	64
22.751.12	12	"A" pack - Roll	118x64x59	107
22.751.22*	12	"A" pack - Flat	105x57x35	107
22.751.32	12	"B" pack - Roll	118x64x59	77
22.751.42*	12	"B" pack - Flat	105x57x35	78.5

OSCULATI

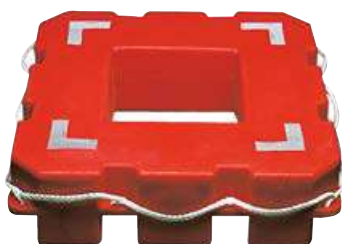

RINA-approved liferaft

For the Merchant Navy and commercial vessels for passenger transport.
Made of plastic filled with polyurethane foam.
Fine quality finish, orange colour. Supplied without reflective tape.

Code	Seats	Type-approval	cm	OPTIONAL reflective tape
22.700.03	8	M.M.M. 1/1991	90x90	22.700.05
22.700.04	12	M.M.M. 2/1991	105x105	22.700.05



22.700.05 Package contains 2 m of RINA type-tested reflective tape 22.300.03. From 1993 on, rescue boats 22.700.03 and 22.700.04 must **compulsorily** be equipped with this belt.

Type-approved reflective tape. 2-m roll

22.700.05 The package includes 2 metres of reflective tape 22.300.03 (approved by RINA). Since 1993 liferafts 22.700.03 and 22.700.04 are required to be fitted with this tape.



Liferaft hydrostatic hook

22.712.00 In compliance with Solas regulations. It activates at a depth of 1,5 to 4 metres by releasing the liferaft from its housing and inflating it.



Mounting kit for liferafts in stiff case

22.711.02 Deck/bulkhead mounting. The kit includes brackets, heavy-duty polyester straps, stainless steel hooks and buckles for quick release. Universal model for our liferafts.

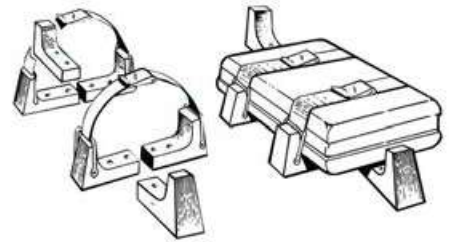

Universal liferaft holder for fast launching

AISI 316

Universal model for all 4- to 12-seat pleasure rafts. Mounting by means of precision-cast stainless steel clamps (4 pcs). Raft fastening by means of a sturdy nylon-coated stainless steel strap + cam hook and padlock ring. Fast launching by opening the cam hook. Mirror-polished AISI 316 stainless steel frame.

OSCOLATI

Code	Mounting
22.700.00	Horizontal on the bulkhead, flat or on the pulpit
22.700.01	Vertical on the bulkhead or on the pulpit

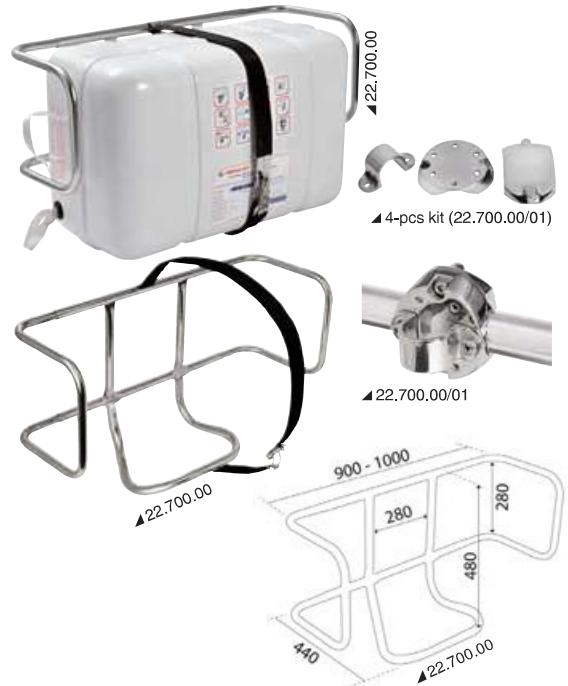

Liferaft holder kit

22.711.03 Liferaft holder kit including L brackets for on-deck or bulkhead installation. AISI316 stainless steel parts. Fitted with self-blocking quick release buckles and high-resistance seam polyester straps.

U Douglas Marine



Dinghies

OSCOLATI

Rubber dinghy with cross slat bottom

Folding version with cross slats on the flat bottom. Once folded, it is the most compact available model for those having limited stowage space. It comes with oars, inflater, repair kit and carrying bag.

Code	Type	Length m	Width m	No. of people	Max power HP	Chambers Ø cm	Air chambers	Max load kg.	↔ deflated cm	kg*
22.620.18	185	1.85	1.31	1+1	2,5	36	2	200	96x56x32	12
22.620.21	210	2.10	1.17	2	3,5	34	2	250	96x56x32	20
22.620.24	240	2.40	1.52	3	6	42	3	450	111x64x32	25

* Weight net of the removable accessories.



Dinghy with high-stiffness inflatable deck floor

This technology combines easy stowage to excellent seaworthiness. Fold after use like a rigid slat dinghy. Ideal in case of limited stowage space. It comes with oars, inflater, repair kit and carrying bag.

Code	Type	Length m	Width m	No of people	Max power HP	Tunnel Ø cm	Air chambers	Permitted load kg	↔ deflated cm	kg*
22.630.25	240	2.4	1.37	2	4	36	3+1	350	101x60x31	23
22.630.28	270	2.7	1.5	3+1	10	42	3+1	484	111x61x35	33
22.630.32	310	3.1	1.51	4+1	15	42	3+1	566	111x61x38	35

* Weight net of the removable accessories



V hull fiberglass dinghy

Excellent seaworthiness. This comfortable dinghy is ideal for leisure and fun in full safety. Good performance even at low gear. Made of Meheler® fabric. It comes with oars, inflator and repair kit.

Code	Type	Length m	Width m	No. of people	Max power HP	Chambers Ø cm	Air chambers	Max load kg	deflated cm	kg**
22.640.22	222	2,22	1,47	2	4	36	3	200	200x110x50	39
22.640.25	250	2,5	1,6	2	5	43	3	450	230x110x50	45
22.640.28	280	2,8	1,6	3	10	43	3	550	280x110x50	55
22.640.31	310	3,1	1,6	4+1	15	43	3	600	300x110x50	70
22.650.33*	330	3,3	2,3	5	20	42	3	600	320x110x50	65

* Double bottom version, flat floor.

** Weight net of the removable accessories.



V hull dinghy made of aluminium

ALUMINIUM HULL

Dinghy made of Mehler®. Rugged yet lightweight construction. Good performance at low speed. Fitted with oars, inflator and repair kit. Version A: regular bottom with inside or outside V-shaped hull. Version B: double bottom. Flat walking surface and small storage locker on the bottom.

Code	Version	Length m	Width m	No. of people	Max power HP	Chamber Ø cm	Air chambers	Max load capacity kg	deflated cm	kg
22.660.29	A	2,90	1,49	3	7,5	42	3	450	280x110x50	44
22.670.32	B	3,20	1,56	4+1	15	42	3	500	300x110x50	64



Polyester dinghy lift system

High-quality, UV-resistant system for lifting any kind of dinghy. High-resistance anodized aluminium lift plate and buckles, AISI316 stainless steel quick release shackles, 400-kg max load. It adjusts to any dinghy. Patented and CE-approved.

Code	Lift version	Usable eyelet-to-eyelet length
22.518.02	two arms, with shackles	min 30 cm - max 138 cm
22.518.04	three arms (2 stern, 1 bow), with 3 shackles	bow strap: min 30 cm - max 360 cm; stern straps: min 30 cm - max 260 cm
22.518.06	three arms, with 1 shackle (bow) and 2 straps for back tube	bow strap: min 30 cm - max 360 cm; stern straps: min 30 cm - max 260 cm (considering a tube of about 50-cm diameter)



Dinghy universal holder

MADE IN ITALY

AISI 316

Made of AISI316 stainless steel with anti-slip rubber coated support. Its special shape can house any kind of dinghy bottom, jet ski or keel. A single move is enough to adjust it without moving the bases installed. The bases are removable, the arm is available in the single and double version, and the holder can be flat or V-shaped to adapt to no matter what requirement.

Code	Base	Side	Support	Capacity kg
22.507.02	removable	single	V shaped	30
22.507.03	removable	double	flat	70
22.507.04	removable	double offset	flat	70



Seat bag

Comfortable and handy, it increases the seat comfort thanks to its soft padding. The shoulder bag can be removed by opening the two zips. The padding remains firmly in place on the seat by means of three practical belts.

Code	Bag dimensions cm	Padding dimensions cm
22.600.01	48x27x20	75x20



New Removable VersaChock tender supports

MADE IN USA

UNIVERSAL

Easily removable supports for tenders, jet skis, or personal watercraft. Designed to be fixed on the stern platform, flybridge, or deck. Four low-profile rounded bases remain fixed on the vessel; the supports can be easily removed to free up deck space. Brackets and bases made of powder-coated aluminum. Supports crafted from HDPE with a rubber support profile.

Code	Version	Capacity kg	Maximum horizontal load kg	Notes	supports LxPxH
22.504.01	Tender Chocks	560	230	-	225x150x25
22.504.02	Tender Chocks Heavy Duty	560	230	Double-width saddles for better weight distribution on the hull	225x150x50



New Davit and support for VersaChock tender

MADE IN USA

TILTING

Thanks to its tilting movement, it eases the hoisting of the tender. Automatic locking system as soon as the tender reaches a horizontal position. End-of-travel straps included (limiting the tilting angle). Can be paired with manual or electric davits. Easily removable system. Mini tool always within reach and connected with an anti-drop lanyard.

Code	Version	Capacity kg	LxPxH mm
22.504.03	Dinghy Davits with wheel 3G	160	1194x77x175



Accessories for OSCULATI dinghies

Code	Description	For dinghies	LxPxH cm
22.600.02	Push-push valve	22.6xx.xx	-
22.680.21	Seat	22.620.21	65x20
22.680.22	Seat	22.620.xx; 22.630.xx; 22.640.xx; 22.660.xx; 22.670.xx	85x20
22.680.24	Pair of oars	22.620.18/21/22/24	137
22.680.25	Pair of oars	22.620.xx; 22.630.xx; 22.640.xx; 22.660.xx; 22.670.xx	167.6

