

# TOHATSU

ES

|  |     |                                  |     |  |     |
|--|-----|----------------------------------|-----|--|-----|
| GUÍA MANTENIMIENTO   | 589 | IGNICIÓN                         | 599 | DESPIECE MOTOR DE 4 TIEMPOS                  | 613 |
| <b>SISTEMA DE ALIMENTACIÓN Y FILTRACIÓN</b>                    | 590 | CARGA                            | 599 | MFS8 • MFS9.9                                | 613 |
| ACEITE   | 595 | BUJÍAS                           | 600 | <b>DESPIECE MOTOR DE 2 TIEMPOS</b>           | 608 |
| BOMBA DE COMBUSTIBLE EN LÍNEA                                  | 590 | CDI Y CAJAS NEGRAS               | 601 | M4C • M5B • M5BS                             | 608 |
| ABRAZADERA PARA MANGUERA                                       | 591 | MOTORES DE ARRANQUE              | 600 | M6B • M8B • M9.8B                            | 609 |
| ADAPTADOR LÍNEA DE COMBUSTIBLE                                 | 591 | SENSORES                         | 598 | M9.9D • M15D2 • M18E2                        | 610 |
| BOMBA DE COMBUSTIBLE   | 590 | SENSOR PRESIÓN ACEITE            | 598 | M25C3 • M30A4                                | 611 |
| LÍNEA DE COMBUSTIBLE   | 590 | SENSOR DE OXÍGENO                | 598 | M40D2 • M50D2                                | 612 |
| MANGUERA DE COMBUSTIBLE  | 590 | SENSOR ÁRBOL DE LEVAS            | 598 | <b>JUNTAS DE MOTOR 4 TIEMPOS</b>             | 617 |
| MUELLE TUBO COMBUSTIBLE  | 591 | TRIM, TILT & POWER TRIM          | 602 | JUNTAS BASE DE MOTOR                         | 618 |
| BOMBA DE COMBUSTIBLE   | 596 | INSTALACIÓN ELÉCTRICA            | 602 | JUNTAS CULATÍN                               | 617 |
| KITS MEMBRANAS Y JUNTAS  | 596 | POWER TRIM COMPLETO              | 602 | JUNTAS DE CULATA                             | 617 |
| CARBURADOR   | 596 | TRIM COMPLETO                    | 602 | KIT JUNTAS DE CULATA                         | 617 |
| BOYAS  | 597 | <b>SISTEMA DE GOBIERNO</b>       | 603 | PISTONES                                     | 619 |
| CARBURADOR COMPLETO  | 596 | COMPONENTES                      | 603 | KIT DE PISTONES                              | 619 |
| KITS CARBURADORES  | 597 | CABLES DE ACELERADOR             | 603 | RETENES DE ACEITE                            | 618 |
| <b>COMPONENTES TANQUE Y CONECTORES</b>                         | 591 | <b>SISTEMA DE REFRIGERACIÓN</b>  | 603 | <b>SISTEMA DE ESCAPE Y ADMISIÓN</b>          | 621 |
| CONECTOR DE DEPÓSITO   | 591 | ÁNODOS                           | 606 | SISTEMA DE ADMISIÓN                          | 621 |
| PASAMAMPAROS   | 592 | ÁNODO CANADA METAL               | 606 | JUNTAS DE ADMISIÓN                           | 621 |
| FILTRO DE ACEITE   | 596 | ÁNODO TECNOSEAL                  | 607 | <b>SISTEMA DE ESCAPE</b>                     | 621 |
| FILTRO DE COMBUSTIBLE Y ELEMENTOS                              | 592 | BOMBA DE AGUA                    | 605 | JUNTAS DE ESCAPE                             | 621 |
| BRACKET  | 592 | CASQUILLO INOX                   | 605 | <b>UNIDADES DE TRANSMISIÓN</b>               | 622 |
| FILTRO DECANTADOR DE COMBUSTIBLE COMPLETO CON VASO TRASPARENTE | 593 | JUNTAS BOMBA                     | 605 | DESPIECE COLAS 4 TIEMPOS                     | 622 |
| FILTRO DECANTADOR DE GASOLINA                                  | 593 | JUNTAS BASE DE BOMBA             | 605 | MFS8 • MFS9.8                                | 622 |
| FILTRO COMBUSTIBLE MONTAJE EN LÍNEA                            | 594 | KITS DE REPARACIÓN BOMBA DE AGUA | 605 | GUÍA PIEZA DE COLA                           | 626 |
| FILTRO COMBUSTIBLE SEPARADOR AGUA                              | 592 | IMPULSORES                       | 604 | <b>SISTEMA DE PROPULSIÓN</b>                 | 627 |
| LLAVES PARA FILTRO   | 594 | TERMOSTATO                       | 603 | HÉLICES ALUMINIO E INOXIDABLE DE 3 Y 4 PALAS | 627 |
| RACOR DE LATÓN   | 594 | JUNTAS TAPA DE REFRIGERACIÓN     | 604 | GUÍA HÉLICES CON NÚCLEO INTEGRADO            | 628 |
| <b>SISTEMA ELÉCTRICO</b>                                       | 598 | JUNTA TERMOSTATO                 | 604 | HÉLICES PARA NÚCLEO INTERCAMBIABLE           | 629 |
| BOBINAS  | 598 | <b>PARTES DEL MOTOR</b>          | 608 | NÚCLEO INTERCAMBIABLE                        | 629 |
| ALTA PRESIÓN   | 599 | CIGÜEÑAL                         | 619 | REF --> RO                                   | 630 |
| PULSACIÓN  | 599 | RODAMIENTOS                      | 619 | RO --> REF                                   |     |

EN

|  |     |                              |     |  |     |
|--|-----|------------------------------|-----|--|-----|
| DRIVES MAINTENANCE GUIDE & KITS              | 589 | IGNITION COIL                | 599 | ENGINE GASKETS 4 STROKES               | 617 |
| <b>FUEL &amp; FILTRATION SYSTEM</b>          | 590 | CHARGER COIL                 | 599 | GASKET, CYLINDER COVER                 | 617 |
| CARBURATOR                                   | 596 | SENSORS                      | 598 | GASKET, CYLINDER HEAD                  | 617 |
| CARBURETOR KITS                              | 597 | SENSOR, OIL PRESURE          | 598 | GASKET KIT, CYLINDER HEAD              | 617 |
| FLOATS                                       | 597 | SENSOR, OXYGEN               | 598 | <b>ENGINE PARTS 2 STROKES</b>          | 608 |
| FULL CARBURATOR                              | 596 | SENSOR, CAMSHAFT             | 598 | M4C • M5B • M5BS                       | 608 |
| <b>FUEL FILTERS AND ELEMENTS</b>             | 592 | SPARK                        | 600 | M6B • M8B • M9.8B                      | 609 |
| BRACKET                                      | 592 | STARTERS                     | 600 | M9.9D • M15D2 • M18E2                  | 610 |
| COMPLET FUEL FILTER                          | 594 | TRIM, TILT & POWER TRIM      | 602 | M25C3 • M30A4                          | 611 |
| COMPLET FUEL FILTER WITH TRANSPARENT BOWL    | 593 | COMPLETE POWER TRIM ASSEMBLY | 602 | M40D2 • M50D2                          | 612 |
| FILTER KEY                                   | 594 | COMPLETE TRIM ASSEMBLY       | 602 | <b>ENGINE PARTS 4 STROKES</b>          | 613 |
| IN-LINE FUEL FILTER                          | 594 | WIRING HARNESS               | 602 | MFS8 • MFS9.9                          | 613 |
| RACORS                                       | 594 | <b>STEERING SYSTEM</b>       | 603 | PISTONS                                | 619 |
| WATER SEPARATING FUEL FILTER                 | 592 | COMPONENTS                   | 603 | PISTON KITS                            | 619 |
| <b>FUEL PUMP</b>                             | 596 | CONTROL CABLES               | 603 | <b>OIL SEALS</b>                       | 618 |
| DIAPHRAGMS & GASKETS                         | 596 | <b>COOLING SYSTEM</b>        | 603 | <b>EXHAUST &amp; INTAKE SYSTEM</b>     | 621 |
| <b>FUEL PUMP IN LINE</b>                     | 590 | ANODES                       | 606 | EXHAUST SYSTEM                         | 621 |
| CLAMP SMALL                                  | 591 | ANODES CANADA METAL          | 606 | GASKETS                                | 621 |
| COUPLER                                      | 591 | ANODES TECNOSEAL             | 607 | INTAKE SYSTEM                          | 621 |
| FUEL HOSE                                    | 590 | IMPELLERS                    | 604 | GASKETS                                | 621 |
| FUEL LINE ASSEMBLY                           | 590 | TERMOSTAT                    | 603 | <b>UNIT DRIVES &amp; COMPONENTS</b>    | 622 |
| SPRING, FUEL PIPE                            | 591 | GASKET BASE                  | 603 | DRIVE COMPONENTS GUIDE                 | 626 |
| <b>FUEL TANK COMPONENTS &amp; CONNECTORS</b> | 591 | EXHAUST INNER COVER          | 604 | GEAR CASE PARTS 4 STROKES              | 622 |
| TANK CONNECTOR                               | 591 | <b>WATER PUMP</b>            | 605 | MFS8 • MFS9.8                          | 622 |
| THRU HULL                                    | 592 | GASKET                       | 605 | <b>PROPULSION SYSTEM</b>               | 627 |
| OIL  | 595 | GASKET BASE                  | 605 | 3 & 4 BLADE ALUMINIUM & SS PROPELLERS  | 627 |
| OIL FILTER                                   | 596 | INSERT CUP                   | 605 | INTERCHANGEABLE HUB                    | 629 |
| <b>ELECTRIC SYSTEM</b>                       | 598 | SERVICE KIT                  | 605 | PROPELLERS APPLICATION WITH RUBBER HUB | 629 |
| CDI & POWER PACK                             | 601 | <b>ENGINE PARTS</b>          | 608 | PROPELLERS FOR INTERCHANGEABLE HUB     | 629 |
| COILS  | 598 | CRANKSHAFT                   | 619 | REF --> OEM                            | 630 |
| COIL HIGH PRESSURE                           | 599 | CRANKSHAFT BEARINGS          | 619 | OEM --> REF                            | 632 |
| PULSER COIL                                  | 599 |                              |     |  |     |

TOHATSU

RECAMBIOS MARINOS

# IT

|   |     |                                    |     |  |     |
|---|-----|------------------------------------|-----|--|-----|
| <b>GUIDA MANUTENZIONE E KIT</b>               | 589 | <b>CDI E CENTRALINA</b>            | 601 | <b>GUARNIZIONE BASE MOTORE</b>               | 618 |
| <b>SISTEMA DI ALIMENTAZIONE E FILTRAZIONE</b> | 590 | <b>MOTORINI AVVIAMENTO</b>         | 600 | <b>GUARNIZIONE TESTATA</b>                   | 617 |
| <b>CARBURATORE</b>                            | 596 | <b>SENSORE</b>                     | 598 | <b>GUARNIZIONE COPERCHIO TESTA</b>           | 617 |
| CARBURATORE COMPLETO                          | 596 | SENSORE PRESIONE OLIO              | 598 | <b>KIT GUARNIZIONE TESTATA</b>               | 617 |
| GALLEGGIANTE                                  | 597 | SENSORE OSSIGENO                   | 598 | <b>PARAOILIO</b>                             | 618 |
| KIT CARBURATORI                               | 597 | SENSORE ALBERO A CAMME             | 598 | <b>PARTI MOTORE 4 TEMPI</b>                  | 613 |
| <b>COMPONENTI SERBATOIO E CONNETTORI</b>      | 591 | <b>TRIM, TILT &amp; POWER TRIM</b> | 602 | MFS8 • MFS9.9                                | 613 |
| ATTACCO SERBATOIO                             | 591 | INSTALLAZIONE ELETTRICA            | 602 | <b>PARTI MOTORE 2 TEMPI</b>                  | 608 |
| PASSASCAFO                                    | 592 | MOTORINO POWER TRIM COMPLETO       | 602 | M4C • M5B • M5BS                             | 608 |
| <b>FILTRI BENZINA E RACCORDI</b>              | 592 | MOTORINO TRIM COMPLETO             | 602 | M6B • M8B • M9.8B                            | 609 |
| CHIAVE DA FILTRO                              | 594 | <b>SISTEMA DI GUIDA</b>            | 603 | M9.9D • M15D2 • M18E2                        | 610 |
| FILTRO BENZINA PER MONTARE IN LINEA           | 594 | <b>COMPONENTI</b>                  | 603 | M25C3 • M30A4                                | 611 |
| FILTRO DECATATORE BENZINA                     | 593 | CAVO ACCELERATORE                  | 603 | M40D2 • M50D2                                | 612 |
| FILTRO DI DECATAZIONE BENZINA                 | 593 | <b>SISTEMA DI RAFFREDDAMENTO</b>   | 603 | <b>PISTONE</b>                               | 619 |
| COMPLETO CON VASCHETTA TRASPARENTE            | 593 | <b>ANODI</b>                       | 606 | KIT PISTONE                                  | 619 |
| FILTRO SEPARATORE ACQUA-BENZINA               | 592 | ANODI CANADA METAL                 | 606 | <b>SISTEMA DI SCARICO E ASPIRAZIONE</b>      | 621 |
| RACCORDI                                      | 594 | ANODI TECNOSEAL                    | 607 | <b>SISTEMA ASPIRAZIONE</b>                   | 621 |
| SUPPORTO                                      | 592 | <b>GIRANTE</b>                     | 604 | GUARNIZIONE                                  | 621 |
| <b>FILTRO OLIO</b>                            | 596 | GUIDA GIRANTE                      | 604 | <b>SISTEMA SCARICO</b>                       | 621 |
| <b>OLIO</b>                                   | 595 | <b>POMPA ACQUA</b>                 | 605 | GUARNIZIONE                                  | 621 |
| <b>POMPA BENZINA</b>                          | 596 | GHIERA INOX                        | 605 | <b>UNITÀ DI TRASMISSIONE</b>                 | 622 |
| MEMBRANA E GUARNIZIONI                        | 596 | GUARNIZIONE BASE POMPA             | 605 | <b>GUIDA COMPONENTI PIEDI</b>                | 626 |
| <b>POMPA BENZINA IN LINEA</b>                 | 590 | GUARNIZIONE POMPA                  | 605 | <b>PARTI PIEDI 4 TEMPI</b>                   | 622 |
| ADATTATORE                                    | 591 | KIT RICAMBI POMPA ACQUA            | 605 | MDF8 • MSF9.8                                | 622 |
| FASCETTE                                      | 591 | <b>TERMOSTATO</b>                  | 603 | <b>SISTEMA DI PROPULSIONE</b>                | 627 |
| MOLLA TUBO COMBUSTIBILE                       | 591 | GUARNIZIONE TERMOSTATO             | 604 | <b>ELICHE ALLUMINIO E INOX DA 2 E 4 PALE</b> | 627 |
| POMPA BENZINA                                 | 590 | GUARNIZIONE COPERCHIO              | 604 | ELICHE PER MOZZO INTERCAMBIABILE             | 629 |
| TUBO BENZINA                                  | 590 | REFRIGERAZIONE                     | 604 | GUIDA ELICHE CON MOZZO                       | 628 |
| <b>SISTEMA ELETTRICO</b>                      | 598 | <b>PARTI MOTORE</b>                | 608 | MOZZO INTERCAMBIABILE                        | 629 |
| <b>BOBINE</b>                                 | 598 | <b>ALBERO MOTORE</b>               | 619 | REF --> RO                                   | 630 |
| BOBINA ALTA PRESSIONE                         | 599 | CUSCINETTI ALBERO MOTORE           | 619 | RO --> REF                                   | 632 |
| BOBINA ACCENSIONE                             | 599 | <b>GUARNIZIONI MOTORE 4 TEMPI</b>  | 617 |  |     |
| BOBINA AVVIAMENTO                             | 599 |                                    |     |  |     |
| BOBINA DI CARICA                              | 599 |                                    |     |  |     |
| <b>CANDELE</b>                                | 600 |                                    |     |  |     |

# FR

|  |     |                                     |     |   |     |
|--|-----|-------------------------------------|-----|---|-----|
| <b>GUIDE MAINTENANCE KITS</b>                    | 589 | <b>BOBINE D'ALLUMAGE</b>            | 599 | <b>JOINTS DE TÊTE MOTRICE</b>                       | 618 |
| <b>SYSTÈME D'ALIMENTATION ET DE FILTRATION</b>   | 590 | <b>BOBINE DE CHARGE</b>             | 599 | <b>KIT JOINTS DE MOTEUR</b>                         | 617 |
| <b>CARBURATEUR</b>                               | 596 | <b>BOUGIES</b>                      | 600 | <b>PIÈCES MOTEURS DE 4 TEMPS</b>                    | 613 |
| CARBURATEUR COMPLET                              | 596 | <b>CAPTEURS</b>                     | 598 | MFS8 • MFS9.9                                       | 613 |
| FLOTTEUR DE CARBURATEUR                          | 597 | CAPTEUR PRESION HUILE               | 598 | <b>PIÈCES MOTEUR 2 TEMPS</b>                        | 608 |
| KIT CARBURATEUR                                  | 597 | CAPTEUR À OXYGENE                   | 598 | M4C • M5B • M5BS                                    | 608 |
| <b>COMPOSANTS ET CONNECTEURS DU RÉSERVOIR</b>    | 591 | CAPTEUR DE POSITION D'ARBRE À CAMES | 598 | M6B • M8B • M9.8B                                   | 609 |
| PASSE-CLOISON                                    | 592 | <b>CDI ET BOITIER ELECTRONIQUE</b>  | 601 | M9.9D • M15D2 • M18E2                               | 610 |
| RACCORDS DE RESERVOIR                            | 551 | DEMARREUR                           | 600 | M25C3 • M30A4                                       | 611 |
| <b>FILTRE À ESSENCE ET CARTOUCHE DE RECHANGE</b> | 592 | <b>TRIM, TILT &amp; POWER TRIM</b>  | 602 | M40D2 • M50D2                                       | 612 |
| CLÉ À FILTRE                                     | 594 | INSTALLATION ELECTRIQUE             | 602 | <b>PISTONS</b>                                      | 619 |
| FILTRE DÉCANTEUR ESSENCE                         | 593 | MOTEUR DE TRIM                      | 602 | KIT PISTON  | 619 |
| FILTRE DÉCANTEUR ESSENCE AVEC BOL TRANSPARENT    | 593 | POWER TRIM COMPLET                  | 602 | <b>VILEBREQUIN</b>                                  | 619 |
| FILTRE À ESSENCE EN LIGNE                        | 594 | <b>SYSTÈME DE COMMANDE</b>          | 603 | ROULEMENTS VILEBREQUIN                              | 619 |
| FILTRE SÉPARATEUR EAU-ESSENCE                    | 592 | <b>COMPOSANT</b>                    | 603 | <b>SYSTÈME D'ÉCHAPPEMENT ET SYSTÈME D'ADMISSION</b> | 621 |
| RACCORDS   | 594 | CÂBLE D'ACCELERATEUR                | 603 | <b>SYSTÈME D'ADMISSION</b>                          | 621 |
| TÊTE DE FILTRE À ESSENCE                         | 592 | <b>SYSTÈME DE REFROIDISSEMENT</b>   | 603 | JOINTS  | 621 |
| <b>FILTRE À HUILE</b>                            | 596 | <b>ANODES</b>                       | 606 | <b>SYSTÈME D'ÉCHAPPEMENT</b>                        | 621 |
| <b>HUILES</b>                                    | 595 | ANODE CANADA METAL                  | 606 | JOINTS  | 621 |
| <b>POIRE À CARBURANT</b>                         | 590 | ANODE TECNOSEAL                     | 606 | <b>EMBASES ET PIÈCES</b>                            | 622 |
| COLLIER  | 591 | <b>TURBINES</b>                     | 604 | <b>PIÈCES D'EMBASES DE 4 TEMPS</b>                  | 622 |
| POIRE À CARBURANT                                | 591 | <b>POMPE D'EAU</b>                  | 605 | MFS8 • MFS9.9                                       | 622 |
| RACCORD COUPLEUR                                 | 591 | INSERT INOX                         | 605 | <b>GUIDE PIÈCES D'EMBASES</b>                       | 626 |
| RESSORT, TUYAU DE CARBURANT                      | 591 | JOINTS, BASE DE POMPE À EAU         | 605 | <b>SYSTEME DE PROPULSION</b>                        | 627 |
| TUYAU CARBURANT                                  | 590 | JOINTS POMPE                        | 605 | <b>HÉLICE ALUMINIUM ET INOX 3 ET 4 PALES</b>        | 627 |
| <b>POMPE À ESSENCE</b>                           | 596 | KIT REPARATION DE POMPE À EAU       | 605 | GUIDE DES HÉLICES ET MOYEUR                         | 628 |
| MEMBRANES ET JOINTS                              | 596 | <b>THERMOSTAT</b>                   | 603 | HELICES AVEC MOYEU INTERCHANGEABLE                  | 628 |
| <b>SYSTÈME ÉLECTRIQUE</b>                        | 598 | JOINT THERMOSTAT                    | 604 | MOYEU INTERCHANGEABLE                               | 629 |
| <b>BOBINES</b>                                   | 598 | JOINT COUVERCLE THERMOSTAT          | 604 | REF --> RO  | 630 |
| BOBINE HAUTE PRESION                             | 599 | <b>PIÈCES MOTEUR</b>                | 608 | RO --> REF  | 632 |
| BOBINE PULSEUR                                   | 599 | <b>JOINTS DE MOTEUR 4 TEMPS</b>     | 617 |   |     |
|  |     | JOINTS COUVRE CULASSE               | 617 |   |     |
|  |     | JOINTS DE CULASSE                   | 617 |   |     |

MAINTENANCE  
GUIDE

GUIDA  
MANUTENZIONE

GUIDE  
MAINTENANCE

|                          | REF             |                        |               |                       |                          |   |
|--------------------------|-----------------|------------------------|---------------|-----------------------|--------------------------|---|
| MFS4<br>MFS5<br>MFS6     | NGKDCPR6E       | BUJÍA                  | SPARK PLUG    | CANDELE               | BOUGIE                   | 1 |
|                          | TEN01259        | ÁNODO                  | ANODE DRIVE   | ANODO                 | ANODE                    | 1 |
|                          | CEF500377       | IMPULSOR               | IMPELLER      | GIRANTE               | TURBINE                  | 1 |
|                          | PAF4-05000300   | FILTRO COMBUSTIBLE     | FUEL FILTER   | FILTRO BENZINA        | FILTRE À ESSENCE         | 1 |
| MFS8<br>MFS9.8           | NGKDCPR6E       | BUJÍA                  | SPARK PLUG    | CANDELE               | BOUGIE                   | 2 |
|                          | TEN01258        | ÁNODO BLOQUE           | ANODE ENGINE  | ANODO MOTORE          | ANODE MOTEUR             | 1 |
|                          | CEF500344       | IMPULSOR               | IMPELLER      | GIRANTE               | TURBINE                  | 1 |
|                          | PAF4-05000300   | FILTRO COMBUSTIBLE     | FUEL FILTER   | FILTRO BENZINA        | FILTRE À ESSENCE         | 1 |
|                          | REC855676002    | TERMOSTATO             | THERMOSTAT    | TERMOSTATO            | TERMOSTAT                | 1 |
|                          | PAF8-05000004   | CORREA<br>DISTRIBUCIÓN | TIMING BELT   | CINGHIE DISTRIBUZIONE | COURROIE DE DISTRIBUTION | 1 |
|                          | TEN01260        | ÁNODO COLA             | ANODE DRIVE   | ANODO PIEDE           | ANODE EMBASSE            | 1 |
| MFS9.9<br>MFS15<br>MFS18 | NGKDCPR6E       | BUJÍA                  | SPARK PLUG    | CANDELE               | BOUGIE                   | 2 |
|                          | TEN01258        | ÁNODO BLOQUE           | ANODE ENGINE  | ANODO MOTORE          | ANODE MOTEUR             | 1 |
|                          | CEF500383       | IMPULSOR               | IMPELLER      | GIRANTE               | TURBINE                  | 1 |
|                          | PAF4-05000300   | FILTRO COMBUSTIBLE     | FUEL FILTER   | FILTRO BENZINA        | FILTRE À ESSENCE         | 1 |
|                          | REC5GH-13440-00 | FILTRO ACEITE          | OIL FILTER    | FILTRO OLIO           | FILTRE À HUILE           | 1 |
|                          | REC855676002    | TERMOSTATO             | THERMOSTAT    | TERMOSTATO            | TERMOSTAT                | 1 |
|                          | TEN01250        | ÁNODO TRANSOM          | TRANSOM ANODE | ANODO TRANSOM         | ANODE TRANSOM            | 1 |
| MFS25<br>MFS30           | NGKDCPR6E       | BUJÍA                  | SPARK PLUG    | CANDELE               | BOUGIE                   | 2 |
|                          | TEN01258        | ÁNODO BLOQUE           | ANODE ENGINE  | ANODO MOTORE          | ANODE MOTEUR             | 1 |
|                          | CEF500382       | IMPULSOR               | IMPELLER      | GIRANTE               | TURBINE                  | 1 |
|                          | PAF4-05000300   | FILTRO COMBUSTIBLE     | FUEL FILTER   | FILTRO BENZINA        | FILTRE À ESSENCE         | 1 |
|                          | REC855676002    | TERMOSTATO             | THERMOSTAT    | TERMOSTATO            | TERMOSTAT                | 1 |
|                          | REC5GH-13440-00 | FILTRO ACEITE          | OIL FILTER    | FILTRO OLIO           | FILTRE À HUILE           | 1 |
|                          | TEN01256        | ÁNODO TRANSOM          | TRANSOM ANODE | ANODO TRANSOM         | ANODE TRANSOM            | 1 |
|                          | TEN01253        | ÁNODO COLA             | ANODE DRIVE   | ANODO PIEDE           | ANODE EMBASE             | 1 |

# SISTEMA DE ALIMENTACIÓN Y FILTRACIÓN FUEL & FILTRATION SYSTEM

# SISTEMA DI ALIMENTAZIONE E FILTRAZIONE SYSTÈME D'ALIMENTATION ET DE FILTRATION

## BOMBA DE COMBUSTIBLE

## FUEL PUMP

## POMPA BENZINA

## POIRE À CARBURANT

### BOMBA DE COMBUSTIBLE

### FUEL PUMP

### POMPA BENZINA



### POIRE À CARBURANT

Fabricada con elastómeros termoplásticos inyectados, resistentes al alcohol y rayos UV.s

Premium quality bulb resistance to alcohol as well as UV and ozone.

Fabbricata con elastomero termoplastico, resistente ai solventi e raggi UV.

Fabriqué avec des élastomères thermoplastiques injectés, résistant à l'alcool et aux rayons UV.

| REF     |  |  |
|---------|---|---|
| GS31187 | 1/4" = 6 mm   | 1   |
| GS31090 | 5/16" = 8 mm  | 1   |
| GS31095 | 3/8" = 9.5 mm   | 1   |
| GS31090 | 5/16" = 8 mm  | 1   |

**GOLDENSHIP**



### LÍNEA DE COMBUSTIBLE

### FUEL LINE ASSEMBLY

### TUBO CARBURANTE



### TUYAU CARBURANT

Universal. Manguera resistente al alcohol.



Universal. Alcohol resistant hose.

Universale. Tubo resistente ai solventi.

Universel. Tuyau résistant à l'alcool.



| REF        |  |  |
|------------|---|---|
| GS31096    | 5/16" x 2 m   | 1   |
| GS31097    | 3/8" x 2 m  | 1   |
| GS31099    | 8 mm x 2 m  | 1   |
| SIE18-8013 | 5/16" x 2 m   | 1   |
| SIE18-8015 | 3/8" x 2 m  | 1   |



| REF     |  |  |
|---------|---|---|
| GS31189 | 3/8" x 2 m  | 1   |

MADE IN THE USA **GOLDENSHIP**



| REF     |  |  |
|---------|--|---|
| GS31183 | 6 mm x 2 m   | 1   |

**GOLDENSHIP**

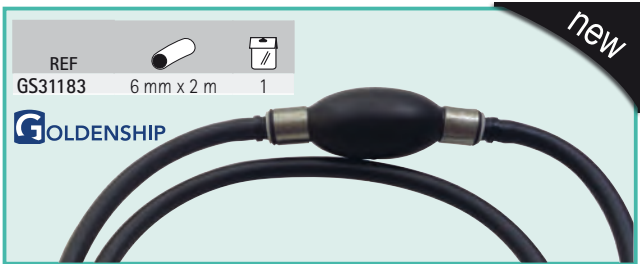

### MANGUERA DE COMBUSTIBLE

### FUEL HOSE

### TUBO BENZINA





### TUYAU CARBURANT

Manguera «Trident» para líneas de combustible. Con refuerzo termoplástico que le permite excelente flexibilidad y resistencia a los rayos UV. Color gris. Resistente al alcohol. Especialmente indicado para motores fueraborda. Garantía: 3 años

Marine fuel hose (distribution and vent) for outboards. Fuel resistant thermo-plastic formulation with 2 spiral reinforcement provides excellent bendability and resistance to UV, aging and permeation by all marine fuels (gasoline/petrol and diesel) including alcohol blends. Warranty: 3 years

Tubo «Trident» per linea combustibile. Con rinforzo termoplastico che gli permette un'eccellente flessibilità e resistenza ai raggi UV. Colore grigio. Resistente ai solventi. Indicato per i motori fuoribordo. Garanzia: 3 anni

Tuyau «Trident» pour carburant. Avec renfort thermoplastique qui permet une excellente flexibilité et résistance aux rayons UV. Gris. Résistant à l'alcool. Convient particulièrement aux moteurs hors-bord. Garantie: 3 ans

| REF         |  |  |  |  |
|-------------|---|---|---|---|
| TRI305-0566 | 5/16" = 7,92 mm   | 15 m  | 1   | SAEJ1527  |
| TRI305-0386 | 3/8" = 9,53 mm  | 15 m  | 1   | ISO-8469 B1 CE  |

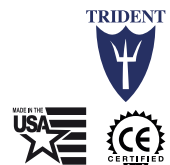

De goma para diesel y gasolina sin plomo. Ideal para fueraborda. Refuerzos textiles internos. Muy flexible. Contenido aromático 50%

Rubber Hose suitable for loading mineral oils, diesel and unloaded fuel

In gomma per diesel e benzina senza piombo. Ideale per motori fuoribordo. Tessuto interno rinforzato. Molto flessibile.

Caoutchouc pour diesel et essence sans plomb. Idéal pour le hors-bord. Renforts textiles internes. Très flexible



### CARBUPOMP/10NL

| REF     |  |  |  |  |  |  |
|---------|---|---|---|---|---|---|
| GS35031 | 6x12  | 10 bar  | 50 mm   | -25°C → 80°C  | 50 m  | ISO R1307   |
| GS35032 | 8x15  | 10 bar  | 65 mm   |   | 50 m  |   |

H.T. - CARBUPOMP/10NL - WP 10 BAR - R-1M Q/m - ISO R1307

**ht**  
HOSES technology

|                                       |   |                               |                                    |            |
|---------------------------------------|---|-------------------------------|------------------------------------|------------|
| <b>MUELLE TUBO COMBUSTIBLE</b>        | <b>SPRING, FUEL PIPE</b>  | <b>MOLLA TUBO COMBUSTIBLE</b> | <b>RESSORT, TUYAU DE CARBURANT</b> | <b>new</b> |
| REF<br>PAF4-04000030<br>PAF4-05000010 |  |                               |                                    |            |

|   |   |  |   |            |
|---|---|--|---|------------|
| <b>ABRAZADERA</b>                                   | <b>CLAMP SMALL</b>  | <b>FASCETTE</b>  | <b>COLLIER</b>  | <b>new</b> |
| REF<br>REC650-24351-51 6 mm<br>REC6E5-24351-51 8 mm |  | REF<br>REC09401-11425 6-8 mm 1<br>REC09401-11425BULK 6-8 mm 25 |  |            |

|   |   |                   |                         |
|---|---|-------------------|-------------------------|
| <b>ADPATADOR LÍNEA DE COMBUSTIBLE</b>     | <b>COUPLER</b>  | <b>ADATTATORE</b> | <b>RACCORD COUPLEUR</b> |
| REF<br>REC22-8M0001721 Ø 11 mm --> Ø 9 mm |  |                   |                         |





|  |   |   |   |
|--|---|---|---|
| <b>COMPONENTES TANQUE Y CONECTORES</b> | <b>FUEL TANK COMPONENTS &amp; CONNECTORS</b>  | <b>COMPONENTI SERBATOIO E CONETTORI</b> | <b>COMPOSANTS ET CONNECTEURS DU RESERVOIR</b>                                       |
| <b>CONECTOR DE DEPÓSITO LATÓN</b>      | <b>TANK CONNECTOR BRASS</b>   | <b>ATTACCO SERBATOIO OTTONE</b>         | <b>RACCORDS DE RESERVOIR LAITON</b>   |
| REF<br>GS31068 1/4" NPT 1              |  |   |  |





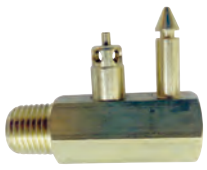

Para conectar dos motores a un sólo depósito, o viceversa. To connect two motors to a single tank, or vice versa. Per collegare due motori a un singolo serbatoio o viceversa. Pour connecter deux moteurs à un même réservoir, ou inversement.

|                           |   |  |   |
|---------------------------|---|--|---|
| REF<br>GS31069 1/4" NPT 1 |  |  |  |
|---------------------------|---|--|---|



|                         |   |   |                         |   |   |
|-------------------------|---|---|-------------------------|---|---|
| REF<br>GS31073 1/4" NPT |  |  | REF<br>GS31020 1/4" NPT |  |  |
|-------------------------|---|---|-------------------------|---|---|



|   |  |   |   |
|---|--|---|---|
| <b>CONECTOR DE DEPÓSITO</b>   | <b>TANK CONNECTOR</b>  | <b>ATTACCO SERBATOIO</b>  | <b>RACCORDS DE RESERVOIR</b>  |
| REF<br>GS31088 3B2-702501M 3/8"   | COMPATIBLE CON CONECTOR<br>COMPATIBLE WITH CONNECTOR<br>COMPATIBLE CON CONNETTORE<br>COMPATIBLE AVEC CONECTEUR<br>2T STROKES<br>4T STROKES<br>5 ---> 90 HP | REF<br>GS31019 99998-OMA2 1/4" NPT  | COMPATIBLE CON CONECTOR<br>COMPATIBLE WITH CONNECTOR<br>COMPATIBLE CON CONNETTORE<br>COMPATIBLE AVEC CONECTEUR<br>2T STROKES<br>4T STROKES<br>GS31088 |
|  |   |  |    |





| REF     | OEM         | 2T STROKES | 4T STROKES | COMPATIBLE CON CONECTOR<br>COMPATIBLE WITH CONNECTOR<br>COMPATIBILE CON CONNETTORE<br>COMPATIBLE AVEC CONECTEUR |
|---------|-------------|------------|------------|---|
| GS31016 | 3B2-702801M | 3/8"       | ✓          | GS31017   |

5 --> 90 HP

| REF     | OEM | 2T STROKES | 4T STROKES | COMPATIBLE CON CONECTOR<br>COMPATIBLE WITH CONNECTOR<br>COMPATIBILE CON CONNETTORE<br>COMPATIBLE AVEC CONECTEUR |
|---------|-----|------------|------------|---|
| GS31017 |     | 1/4" NPT   | ✓          | GS31016   |

5 --> 90 HP

| REF     | OEM         | 2T STROKES | 4T STROKES | GOLDENSHIP      |
|---------|-------------|------------|------------|-----------------|
| GS31018 | 3B2-702601M | Metrica    | ✓          | MADE IN THE USA |

5 --> 90 HP

| REF     | OEM         | 2T STROKES | 4T STROKES | GOLDENSHIP      |
|---------|-------------|------------|------------|-----------------|
| GS31015 | 394-702500M | 3/8"       | ✓          | MADE IN THE USA |

| PASAMAMPAROS  | THRU HULL   | PASSASCAFO  | PASSE-CLOISON  |
|---|---|---|--|
| Para atravesar mamparos de hasta 12 mm. Fabricado en latón. | For bulkhead up to 12 mm. Made in machined brass. | Per attraversare paratie fino a 12 mm. Fabricato in ottone. | Pour traverser des cloisons jusqu'à 12 mm. Fait en laiton. |

| REF     | 2T   | 4T |
|---------|------|----|
| GS31064 | 3/8" | 1  |

| FILTRO DE COMBUSTIBLE Y ELEMENTOS   | FUEL FILTERS AND ELEMENTS   | FILTRI BENZINA E RACCORDI  | FILTRE A ESSENCE ET CARTOUCHE DE RECHANGE                                   |
|---|---|--|---|
| BRACKET   | BRACKET   | SUPPORTO   | TÊTE DE FILTRE À ESSENCE  |
| Con 2 tapones de bronce y 2 tubos de extensión. (2 entradas y 2 salidas). | With 2 brass plugs and 2 extension tubes. (2 inputs & 2 outputs). | Con 2 tappi di bronzo e 2 tubi di estensione. (2 ingressi entrata carburante e 2 uscite carburante). | Avec 2 bouchons en bronze et 2 tubes d'extension. (2 entrées et 2 sorties). |

| REF          | 2T   | 4T   |
|--------------|------|--|
| REC25000     | 1/4" | AL   |
| REC25010     | 1/4" | INOX /SS AISI316                           |
| REC25020     | 3/8" | AL   |
| REC25030     | 3/8" | INOX /SS AISI316                           |
| RECOBBRACKET | 1/4" | Plástico   Plastic<br>Plastica   Plastique |

REC25000 - REC25020      REC25010 - REC25030      RECOBBRACKET

| FILTRO COMBUSTIBLE SEPARADOR DE AGUA | WATER SEPARATING FUEL FILTER | FILTRO SEPARATORE ACQUA-BENZINA | FILTRE SEPARATEUR EAU-ESSENCE |
|--------------------------------------|------------------------------|---------------------------------|-------------------------------|
| REF                                  | MICRON                       |                                 |                               |
| REC24942                             | 10                           |                                 |                               |
| REC35-802893Q01                      | 3Y7-02234-0                  |                                 |                               |
| REC855686                            | 28                           |                                 |                               |
| REC35-802893Q                        | 25                           |                                 |                               |
| RACPF5510                            | 10                           |                                 |                               |

RACPF5510      REC24942      REC35-802893Q01      REC855686      REC35-802893Q



| Filtro original. | OEM filter. | Filtro benzina originale. | Filtre à essence d'origine |
|------------------|-------------|---------------------------|----------------------------|
| REF              | MICRON      |                           |                            |
| RM35-802893Q     | 10          |                           |                            |

**FILTRO CON BRACKET**  
Con 2 tapones de bronce y 1 tubo de extensión.

**OEM FILTER WITH BRACKET**  
With 2 brass plugs & 1 extension tube.

**FILTRO BENZINA CON SUPPORTO**  
Con 2 tappi di bronzo e 1 tubo di estensione.

**FILTRE A ESSENCE AVEC SUPPORT**  
avec 2 bouchons en bronze et 1 tube d'extension

| REF      | MICRON |  |  |  |
|----------|--------|---|---|---|
| REC24950 | 25     | 1/4"  | 50 GPH  | AL  |
| REC24952 | 10     | 1/4"  | 50 GPH  | AL  |





**FILTRO DECANTADOR DE COMBUSTIBLE COMPLETO CON VASO TRASPARENTE**



**COMPLET FUEL FILTER WITH TRANSPARENT BOWL**

**FILTRO DI DECANTAZIONE BENZINA COMPLETO CON VASCHETTA TRASPARENTE**

**FILTRE DÉCANTEUR ESSENCE AVEC BOL TRANSPARENT**

| REF            |  |  |
|----------------|---|---|
| RAC320R-RAC-01 |   | AL  |
| RAC320R-RAC-03 | RACS3213<br>LENS3213  | Plástico<br>Plastic<br>Plastica<br>Plastique                                      |



| REF        |  |  |  |
|------------|---|---|---|
| RECOFILALU |   |   | AL  |
| RECOFILTER | RECOBELEMENT<br>LENS3213  | 150 l/h   | Plástico<br>Plastic<br>Plastica<br>Plastique  |







**FILTRO CON BOMBA CEBADORA**

**FILTER WITH PRIMMING PUMP**

**FILTRO CON POMPETA PER RIEMPIRE**

**FILTRE A ESSENCE AVEC POMPE D'AMORCAGE**

| REF            |  | MICRON |  |  |  |
|----------------|---|--------|---|---|---|
| RAC490R-RAC-01 | RACS3227<br>LENS3227  | 10     | 340 l/h   | 3/8" NPTF   | 150 hp  |



**FILTRO DECANTADOR GASOLINA**

**COMPLETE FUEL FILTER**

**FILTRO DECANTATORE BENZINA**

**FILTRE DÉCANTEUR ESSENCE**

Filtro de combustible con braket.

Complete fuel filter with braket.

Filtro combustibile con supporto.

Filtre à carburant avec support.

| REF         |  |
|-------------|---|
| RAC23299-10 | RAC23289-10   |

130 HP (4 T/ Strokes)



TOHATSU

RECAMBIOS MARINOS

| REF            | MICRON | Flow    | HP     |
|----------------|--------|---------|--------|
| REC90794-46866 | 10     | 117 l/h | 175 hp |



**LLAVE PARA FILTRO**  
**FILTER KEY**  
**CHIAVE DA FILTRO**  
**CLÉ A FILTRE**

REF  
RECYS-225-15



Ø 8mm

| REF             | MICRON | Flow  |
|-----------------|--------|-------|
| PAF40-0701000EI | 10     | 70 hp |



Ø 6 mm



new

**RÁCORES**

**RACORS**

**RACCORDI**

**RACCORDS**

| REF     | Thread   | Size           | Qty |
|---------|----------|----------------|-----|
| GS31065 | 1/4" NPT | 3/8" = 9.5 mm  | 1   |
| GS31166 | 1/4" NPT | 5/16" = 7.9 mm | 2   |
| GS31155 | 3/8" NPT | 3/8" = 9.5 mm  | 2   |
| GS31156 | 3/8" NPT | 5/16" = 7.9 mm | 2   |
| GS31157 | 3/8" NPT | 1/4" = 6.4 mm  | 2   |



| REF     | Thread   | Size           | Qty |
|---------|----------|----------------|-----|
| GS31066 | 1/4" NPT | 5/16" = 7.9 mm | 2   |
| GS31067 | 1/4" NPT | 3/8" = 9.5 mm  | 2   |



**GOLDENSHIP**

**LLAVES PARA FILTRO**

**FILTER KEY**

**CHIAVE DA FILTRO**

**CLÉ À FILTRE**

REF  
RACRK22628

**RACOR**



REF  
REC70720 65 - 110 mm

**RECMAR**



**FILTRO COMBUSTIBLE PARA MONTAJE EN LINEA**

**IN-LINE FUEL FILTER**

**FILTRO BENZINA PER MONTARE IN LINEA**

**FILTRE A ESSENCE EN LIGNE**

| REF     | Flow    | Size    | Material                                  | Qty |
|---------|---------|---------|---|-----|
| GS31001 | 50 l/h  | 6-8 mm  | plástico / plastic / plastica / plastique | 1   |
| GS31002 | 150 l/h | 8-10 mm | plástico / plastic / plastica / plastique | 1   |



GS31001



GS31002

**GOLDENSHIP**

| REF            | OEM                                       |
|----------------|---|
| PAF15-07080000 | 3AC-02230-0<br>3AD-02230-0<br>3B7-02230-0 |

MFS25  
MFS25B  
MFS30



new







| REF     |  |  |  |
|---------|---|---|---|
| GS30435 | 6, 8, 10 mm   | metal + cristal<br>metal + crystal<br>metallo + cristallo<br>métal + verre        | 1   |





**GOLDENSHIP**

| REF   | OEM                         |
|---|-----------------------------|
| REC35-80365M  |                             |
|  6 | (1989, 1992-99)             |
| 8   | (1989-99, 2001-02)          |
| F4  | (1999-02)                   |
| F9.9  | (1989-95, 1997-99, 2001-02) |
| FT 9.9  | (1988-90)                   |



| REF      | OEM   |  |  |  |
|----------|-------|---|---|---|
| REC40145 | 40145 | 1/4"  | 1/4"  | plástico  |
| REC40155 | 40155 | 5/16"   | 5/16"   | plastic   |
| REC40165 | 40165 | 3/8"  | 3/8"  | plastica  |
| REC40135 | 40135 | 5/16"   | 3/8"  | plastique   |



| REF  | OEM                        |
|--|----------------------------|
| PAF4-05000300  | 346-02230-0<br>366-02230-0 |
|  M5 | MFS4                       |
| M9.8   | MFS5                       |
| M9.9   | MFS6                       |
| M15  | MFS8                       |
| M18  | MFS9.9                     |
| M40  | MFS15                      |
|  | MFS20                      |
|  | MFS30                      |



| REF   | OEM            |
|---|----------------|
| REC16911-ZZ5-003  | HZZ5-16911-003 |
|  BFTW60A |                |
| BFT60A  |                |



**new**

| REF  | OEM            |
|--|----------------|
| REC16911-ZY3-010   | HZY3-16911-010 |
|  BFT75AK1 |                |
| BFT90AK1   |                |
| BFT115A  |                |
| BFT250A  |                |
| BFT225A  |                |
| BFT200A  |                |
| BFT150A  |                |



**new**

**ACEITE OIL OLIO HUILES**

| REF        |  |  |           |
|------------|---|---|-----------|
| REC2TU6    | 1 L   | 6   | 2 STROKES |
| REC2TU3    | 5 L   | 3   | TC-W3     |
| REC5W40U6  | 1 L   | 6   | SAE 5W40  |
| REC5W40U3  | 5 L   | 3   |           |
| REC10W30U6 | 1 L   | 6   | SAE 10W30 |
| REC10W30U3 | 5 L   | 3   |           |
| REC10W40U6 | 1 L   | 6   | SAE 10W40 |
| REC10W40U3 | 5 L   | 3   |           |
| REC25W40U3 | 5 L   | 3   | SAE 25W40 |
| REC80W90U3 | 5 L   | 3   | SAE 80W90 |
| REC80W90U6 | 1 L   | 6   |           |



**RECLUBE**

**new**

| REF              |  |  |           |
|------------------|---|---|-----------|
| RM92-858026QB1U6 | 1 L   | 6   | 2 STROKES |
| RM92-858027QB1U3 | 3,8 L   | 3   |           |
| RM92-8M0086220U6 | 1 L   | 6   | SAE 10W30 |
| RM92-8M0086221U3 | 4 L   | 3   |           |



**QUICKSILV**

RM92-858026QB1U6 RM92-858027QB1U3 RM92-8M0086220U6 RM92-8M0086221U3

FILTRO DE ACEITE

OIL FILTER

FILTRO OLIO

FILTRE À HUILE

| REF             | OEM                                       | 4T STROKES |
|-----------------|---|------------|
| REC5GH-13440-00 | 3R3R76150M<br>3RO-07615-0<br>5GH-13440-00 | ✓          |

 MFS15  
 MFS20  
 MFS20  
 MFS30  
 MFS40  
 MFS50  
 MFS60



| REF                | OEM                            |
|--------------------|--------------------------------|
| REC15400-PLM-A01PE | HPLM-15400-A0<br>HPLM-15400-PE |

 BFT75AK1  
 BFT90AK1  
 BFT225A  
 BFT250A  
 BFT200A  
 BFT150A  
 BFT115A

**new**



BOMBA DE COMBUSTIBLE

FUEL PUMP

POMPA BENZINA

POMPE À ESSENCE

MEMBRANAS Y JUNTAS

DIAPHRAGMS & GASKETS

MEMBRANA E GUARNIZIONI

MEMBRANES ET JOINTS

| REF        | OEM         |
|------------|-------------|
| REC8537312 | 350-04005-0 |

 M9.9D2  
 M15D2  
 M18E2  
 M40D2  
 M50D2

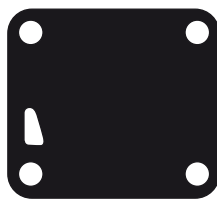

| REF           | OEM         |
|---------------|-------------|
| REC27-8555691 | 3C8-04028-0 |

 M9.9D2  
 M15D2  
 M18E2  
 M40D2  
 M50D2

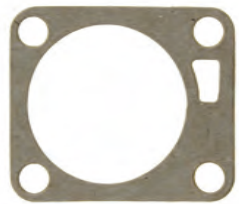

| REF A    | OEM         |
|----------|-------------|
| REC16275 | 369-03303-0 |

 M4C  
 M5B  
 M5BS  
 M6B  
 M8B  
 M9.8B

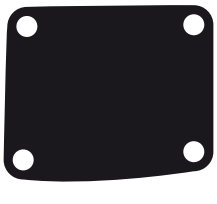

| REF         | OEM         |
|-------------|-------------|
| REC27-16274 | 369-03302-0 |

 M4C  
 M5B  
 M5BS  
 M6B  
 M8B  
 M9.8B

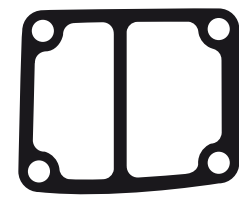

| REF B    | OEM         |
|----------|-------------|
| REC16325 | 369-03306-0 |

 M4C  
 M5B  
 M5BS  
 M6B  
 M8B  
 M9.8B



| REF         | OEM         |
|-------------|-------------|
| REC27-16326 | 369-03307-0 |

 M4C  
 M5B  
 M5BS  
 M6B  
 M8B  
 M9.8B

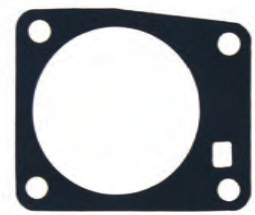

CARBURADOR

CARBURATOR

CARBURATORE

CARBURATEUR

CARBURADOR COMPLETO

FULL CARBURATOR

CARBURATORE COMPLETO

CARBURATEUR COMPLET

| REF           | OEM                        | 4T STROKES |
|---------------|----------------------------|------------|
| PAF8-05040000 | 3F5-03100-0<br>3V2-03100-2 | ✓          |

 MFS8  
 MFS9.8HP



TOHATSU

RECAMBIOS MARINOS

**KITS CARBURADORES**

**CARBURETOR KITS**

**KIT CARBURATORI**

**KIT CARBURATEUR**

| REF             | OEM         |
|-----------------|-------------|
| REC6H3-W0093-02 | 346-87122-0 |

  
 45A2  
 50C  
 60C  
 70A2  
 M25C3  
 M30A4

| REF             | OEM                        |
|-----------------|----------------------------|
| REC6G1-W0093-00 | 369-87122-1<br>3B2-87122-0 |

  
 5B  
 8B  
 9.8  
 M4

| REF             | OEM         |
|-----------------|-------------|
| REC6H4-W0093-03 | 3F3-87122-1 |

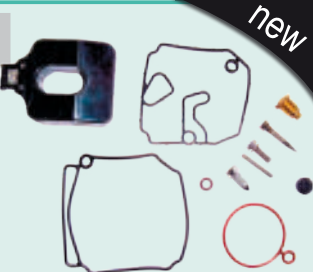
  
 M70

| REF             | OEM         |
|-----------------|-------------|
| REC66M-W0093-01 | 3V1-87122-0 |

  
 MFS8  
 MFS9

| REF                | OEM         |
|--------------------|-------------|
| REC6H1-W0093-01-00 | 346-87122-0 |

  
 M25  
 M30

| REF             | OEM         |
|-----------------|-------------|
| REC696-W0093-00 | 345-87122-4 |

  
 C2  
 M40

| REF             | OEM         |
|-----------------|-------------|
| REC6A1-W0093-01 | 3F0-87122-2 |

  
 M2.5  
 M3.5

**KITS 2 CARBURADORES**

**KITS FOR 2 CARBURETORS**

**KIT 2 CARBURATORI**

**KIT 2 CARBURATEURS**

| REF       | OEM         |
|-----------|-------------|
| REC84419M | 345-87122-0 |

  
 M35C  
 M40C

| REF             | OEM                        |
|-----------------|----------------------------|
| REC6L2-W0093-00 | 3C8-87122-2<br>3G2-87122-2 |

  
 M50  
 M15  
 M18

**BOYAS**

**FLOATS**

**GALLEGGIANTE**

**FLOTTEUR DE CARBURATEUR**

| REF       | OEM         |
|-----------|-------------|
| REC162532 | 3C8-03125-0 |

  
 M9.9D2  
 M15D2  
 M18W2  
 M40D2

| REF      | OEM         |
|----------|-------------|
| REC16253 | 369-03231-0 |

  
 M4B  
 M5B  
 M5BS  
 M6B

# SISTEMA ELÉCTRICO ELECTRIC SYSTEM

# SISTEMA ELETTRICO SYSTEME ÉLECTRIQUE

## SENSORES

## SENSORS

## SENSORE

## CAPTEURS

### SENSOR PRESIÓN DE ACEITE

### OIL PRESURE SENSOR

### SENSORE PRESIONE OLIO

### CAPTEUR PRESION HUILE

| REF   | OEM         |
|---|-------------|
| PAF15-07010100  | 3H6-07611-0 |
|  MFS4 --> MFS40 HP |             |





### SENSOR DE OXÍGENO

### OXYGEN SENSOR

### SENSORE OSSIGENO

### SONDE À OXYGENE

| REF  | OEM            |
|--|----------------|
| REC35668-ZY6-003   | HZY6-35668-003 |
|  BFT150A<br>BFT115A |                |



### SENSOR POSICIÓN ÁRBOL DE LEVAS

### CAMSHAFT SENSOR

### SENSORE ALBERO A CAME

### CAPTEUR DE POSITION D'ARBRE A CAMES

| REF  | OEM            |
|--|----------------|
| REC37510-PNB-003   | HPNB-37510-003 |
|  BFT150A<br>BFT115A |                |



## BOBINAS

## COILS

## BOBINE

## BOBINES

### BOBINA

### COIL

### BOBINA

### BOBINE

| REF  | OEM         |
|--|-------------|
| PAF8-05000300  | 3AA-06021-0 |
|  MFS8<br>MFS9.8 |             |



| REF  | OEM         |
|--|-------------|
| REC3G3-06021-1   | 3G3-06021-1 |
|  M9.9D2<br>M15D2<br>M18E2<br>M25C3<br>M30A4 |             |



| REF   | OEM         |
|---|-------------|
| REC369-06021-0  | 369-06021-0 |
|  M4C<br>M5B-BS |             |



TOHATSU

RECAMBIOS MARINOS



**BOBINA ENCENDIDO****STARTER COIL****BOBINA AVVIAMENTO****BOBINE DEMARREUR**

| REF           | OEM                                    |
|---------------|--|
| PAF8-05000500 | 3V1-06040-0<br>3V1060400<br>3V1060400M |

**BOBINA DE PULSACIÓN****PULSER COIL****BOBINA ACCENSIONE****BOBINE PULSEUR**

| REF           | OEM         |
|---------------|-------------|
| PAF8-05000200 | 3V1-06071-0 |

**BOBINA DE IGNICIÓN****COIL IGNITION****BOBINA AVVIAMENTO****BOBINE D'ALLUMAGE**

| REF            | OEM         |
|----------------|-------------|
| REC3A0-06040-1 | 3A0-06040-1 |



| REF            | OEM         |
|----------------|-------------|
| REC3G2-06040-2 | 3G2-06040-2 |



| REF              | OEM            |
|------------------|----------------|
| REC30580-ZV4-013 | HZV4-30580-013 |

BFT75AKI  
BFT90AKI

**BOBINA DE CARGA****CHARGER COIL****BOBINA DI CARICA****BOBINE DE CHARGE**

| REF            | OEM         |
|----------------|-------------|
| PAF8-05090000W | 3V1-06023-0 |



# BUJÍAS

# SPARK

# CANDELE

# BOUGIES

| 2T STROKES                   | REF NGK      | RO / OEM    |
|------------------------------|--------------|-------------|
| M2.5/ M3.5/ 3/ 5B2           | NGKBPR6HS-10 | 9701-1-1013 |
| M4/ M5/ M6/ M8/ M9.8         | NGKBPR7HS-10 | 9701-1-1014 |
| M9.9/ M25/ M30/ 40D2         | NGKBR7HS-10  | 9701-1-1015 |
| MX40/ 50D3                   | NGKB8HS-10   | 9701-1-1006 |
| MC4 through 9.8B, MX15/ 18E2 | NGKBP7HS-10  | 9701-1-1010 |
| M25/ 30H/ MX25               | NGKB7HS-10   | 9701-1-1005 |
| M50D2 Through 140A2          | NGKBR8HS-10  | 9701-1-1110 |

| 4T STROKES                     | REF NGK     | RO / OEM       |
|--------------------------------|-------------|----------------|
| MFS2.5 Through 30C             | NGKDCPR6E   | 9701-1-1103    |
| MD30/ MD40/ MD50/ MD75/ MD90   | NGKIZFR6    | 9701-1-1111    |
| MFS40/ 50A (Serial 046502AE +) | NGKIKR6G8   | 9701-1-1121    |
| MD115A2 (TLDI)                 | NGKIZFR5J   | 9791-1-1109    |
| BFT60A                         | NGKLMAR6C-9 | HZZ3-31909-003 |



| 2T STROKES       | REF CHAMPION |
|------------------|--------------|
| M3.5A / B        | CHAL87YCC    |
| M5B / BS         | CHAL82YC     |
| M6B              | CHAL82YC     |
| M8A / B 2Cil.    | CHAL82YC     |
| M9.9B2 / C 2Cil. | CHAL82C      |
| B18C / D         | CHAL86C      |
| M12B             | CHAL82C      |
| M15A / B2 2Cil.  | CHAL82C      |
| M15C / D         | CHAL82C      |
| M16              | CHAL82C      |
| M18A / C2 2Cil.  | CHAL82C      |
| M18D / E         | CHAL82C      |
| M20              | CHAL82C      |

| 2T STROKES      | REF CHAMPION |
|-----------------|--------------|
| B40A            | CHAL86C      |
| B30C            | CHAL86C      |
| M25C / C2 2Cil. | CHAL82C      |
| M30A / A3 2Cil. | CHAL82C      |
| M35A            | CHAL82YC     |
| M40C 2Cil.      | CHAL82YC     |
| M40D 3Cil.      | CHAL82YC     |
| M50C / D 3Cil.  | CHAL78C      |
| M70A / A2 3Cil. | CHAL78C      |
| M70B            | CHAL78C      |
| M90A 3Cil.      | CHAL78C      |
| M115A 4Cil.     | CHAL78C      |
| M140A 4Cil.     | CHAL78C      |

| 4T STROKES | REF CHAMPION |
|------------|--------------|
| MFS4       | OHV CHARA8HC |
| MFS5A      | OHV CHARA8HC |
| MFS5C      | OHV CHARA8HC |
| MFS9.9A    | OHV CHARA8HC |
| MFS15A     | OHV CHARA8HC |



P 49  
REF REC004



REF CHAPROSU

# MOTORES DE ARRANQUE

# STARTERS

# MOTORINI AVVIAMENTO

# DÉMARREURS

## MOTORES DE ARRANQUE STARTERS

| REF        | OEM                                    | ⚡   | ☀️     | 2T STROKES | 4T STROKES |
|------------|--|-----|--------|------------|------------|
| PH130-0006 | 3C8-76010-1<br>3C8760101<br>3C8760101M | 12V | 0.6 kw | 9 CCW      | ✓ ✓        |

- M40D2/B2
- M50D2/B2
- M70C
- MFS9.9B2-C
- MFS15B2-C
- MFS18B2
- MFS20C
- MFS25A-B
- MFS30B



## MOTORINI AVVIAMENTO DÉMARREURS

| REF        | OEM                      | ⚡ | ☀️ | 2T STROKES | 4T STROKES |
|------------|--------------------------|---|----|------------|------------|
| PH130-0061 | 350-76010-0<br>3AA760100 |   |    | ✓          | ✓          |

- M15D2
- M18E2
- M8B
- M9.8B
- M9.9D2
- MFS8A2
- MFS9.8A2



| REF        | OEM         | ⚡ | ☀️ | 2T STROKES | 4T STROKES |
|------------|-------------|---|----|------------|------------|
| PH130-0048 | 353-76010-4 |   | 9  | ✓          |            |

- MD70B
- MD90B
- MD115A-A2
- MD120A2
- MD140A2



| REF        | OEM   | ⚡ | ☀️ | 2T STROKES | 4T STROKES |
|------------|---|---|----|------------|------------|
| PH130-0080 | 346-76010-0,<br>346-76010-0A0<br>346-76010-0M |   |    | ✓          |            |

- M25C3
- M30A4
- M40C





TOHATSU

RECAMBIOS MARINOS

**new**



| REF              | OEM            | ⚡ | ☀️ | 2T<br>STROKES | 4T<br>STROKES |
|------------------|----------------|---|----|---------------|---------------|
| REC31200-ZY6-003 | HZY6-31200-003 |   |    |               | ✓             |

 BFT150A  
 BFT115A



**new**

| REF        | OEM            | ⚡ | ☀️ | 2T<br>STROKES | 4T<br>STROKES |
|------------|----------------|---|----|---------------|---------------|
| PH130-0070 | HZY3-31200-003 |   |    |               | ✓             |

 BFT250A  
 BFT225A  
 BFT200A



**CDI Y CAJAS NEGRAS**

**CDI & POWER PACK**

**CDI E CENTRALINA**

**CDI ET BOITIER ELECTRONIQUE**

| REF            | OEM         |
|----------------|-------------|
| REC3F0-06060-0 | 3F0-06060-0 |

 M2.5A2  
 B3.5A2-B2





| REF            | OEM                        |
|----------------|----------------------------|
| REC353-06260-0 | 353-06260-2<br>353-06260-0 |

 45A2  
 55B  
 60A  
 75A2







| REF            | OEM         |
|----------------|-------------|
| REC3G2-06060-2 | 3G2-06060-2 |

 M9.9D2  
 B15D2  
 M18E2





| REF            | OEM                                       |
|----------------|---|
| REC3A106-2602M | 3A106-2402M<br>3A106-2601M<br>3A106-2602M |

 25C2  
 30A3  
 40C



| REF           | OEM                        |
|---------------|----------------------------|
| PAF8-05000400 | 3AA-06060-00<br>3AA060600M |

 MFS8  
 BFS9.8



## TRIM, TILT & POWER TRIM

### INSTALACIÓN ELÉCTRICA

### WIRING HARNESS

### INSTALLAZIONE ELETTRICA

### INSTALLATION ELECTRIQUE

#### KIT CONVERSIÓN

Sustituye de 2 a 3 cables.

#### CONVERSION KIT

Converts 3-wire Tilt and Trim motors to 2-Wire design

#### KIT CONVERSIONE

Sustituisce da 2 a 3 cavi.

#### KIT DE CONVERSION.

Passes un faisceau de 2 à 3 fils

REF

PH200-WH01



### TRIM COMPLETO

### COMPLETE TRIM ASSEMBLY

### MOTORINO TRIM COMPLETO

### MOTEUR DE TRIM

REF

OEM



PH200-T024

12V

3

2

✓

2T STROKES  
4T STROKES

V4, V6 (1990-03)



### POWER TRIM COMPLETO

### COMPLETE POWER TRIM ASSEMBLY

### MOTORINO POWER TRIM COMPLETO

### POWER TRIM COMPLET

REF

2T STROKES  
4T STROKES

REC18-6865

✓

✓

3 RAM  
115-225HP

SHOWA SYSTEM







# SISTEMA DE GOBIERNO STEERING SYSTEM

# SISTEMA DI GUIDA SYSTÈME DE COMMANDE

| COMPONENTES   | COMPONENTS     | COMPONENTI        | COMPOSANT            |             |  |  |  |
|---|----------------|-------------------|----------------------|-------------|--|--|--|
| CABLE DE ACELERADOR   | THROTTLE CABLE | CAVO ACCELERATORE | CÂBLE D'ACCELERATEUR |             |  |  |  |
| <table border="1"> <thead> <tr> <th>REF</th> <th>OEM</th> </tr> </thead> <tbody> <tr> <td>REC804898</td> <td>3B2-63600-1</td> </tr> </tbody> </table> <ul style="list-style-type: none"> <li>M6B</li> <li>M8B</li> <li>M9.8B</li> </ul> | REF            | OEM               | REC804898            | 3B2-63600-1 |  |  |  |
| REF   | OEM            |                   |                      |             |  |  |  |
| REC804898   | 3B2-63600-1    |                   |                      |             |  |  |  |

# SISTEMA DE REFRIGERACIÓN COOLING SYSTEM

# SISTEMA DI RAFFREDDAMENTO SYSTÈME DE REFRROIDISSEMENT

| TERMOSTATO  | THERMOSTAT     | TERMOSTATO | THERMOSTAT |                |                |     |   |   |     |     |    |                  |                |  |   |
|---|----------------|------------|------------|----------------|----------------|-----|---|---|-----|-----|----|------------------|----------------|--|---|
| TERMOSTATO  | THERMOSTAT     | TERMOSTATO | THERMOSTAT |                |                |     |   |   |     |     |    |                  |                |  |   |
| <table border="1"> <thead> <tr> <th>REF</th> <th>OEM</th> <th>°C</th> </tr> </thead> <tbody> <tr> <td>REC855676002</td> <td>3R3-01030-0</td> <td>60°</td> </tr> </tbody> </table> <ul style="list-style-type: none"> <li>MFS8</li> <li>MFS30</li> </ul>   | REF            | OEM        | °C         | REC855676002   | 3R3-01030-0    | 60° |  | <table border="1"> <thead> <tr> <th>REF</th> <th>OEM</th> <th>°C</th> </tr> </thead> <tbody> <tr> <td>REC19300-ZV5-043</td> <td>HZV5-19300-043</td> <td></td> </tr> </tbody> </table> <ul style="list-style-type: none"> <li>BFT115A</li> <li>BFT130A</li> <li>BFT150A</li> </ul> | REF | OEM | °C | REC19300-ZV5-043 | HZV5-19300-043 |  |  |
| REF   | OEM            | °C         |            |                |                |     |   |   |     |     |    |                  |                |  |   |
| REC855676002  | 3R3-01030-0    | 60°        |            |                |                |     |   |   |     |     |    |                  |                |  |   |
| REF   | OEM            | °C         |            |                |                |     |   |   |     |     |    |                  |                |  |   |
| REC19300-ZV5-043  | HZV5-19300-043 |            |            |                |                |     |   |   |     |     |    |                  |                |  |   |
| <table border="1"> <thead> <tr> <th>REF</th> <th>OEM</th> <th>°C</th> </tr> </thead> <tbody> <tr> <td>PAF15-07000031</td> <td>HZW9-19300-003</td> <td></td> </tr> </tbody> </table> <ul style="list-style-type: none"> <li>BFT90AK1</li> <li>BFT75AK1</li> <li>BFT60A</li> <li>BFTW60A</li> </ul> | REF            | OEM        | °C         | PAF15-07000031 | HZW9-19300-003 |     |  |   |     |     |    |                  |                |  |   |
| REF   | OEM            | °C         |            |                |                |     |   |   |     |     |    |                  |                |  |   |
| PAF15-07000031  | HZW9-19300-003 |            |            |                |                |     |   |   |     |     |    |                  |                |  |   |

**JUNTA TERMOSTATO**

**THERMOSTAT, GASKET BASE**

**GUARNIZIONE TERMOSTATO**

**JOINT DE THERMOSTAT**

| REF            | OEM         |
|----------------|-------------|
| REC3T9-01032-0 | 3T9-01032-0 |

MD75C2  
MD70B / C2  
MD90D / C2



**JUNTAS TAPA DE REFRIGERACIÓN**

**GASKETS EXHAUST INNER COVER**

**GUARNIZIONE COPERCHIO REFRIGERAZIONE**

**JOINT DE COUVERCLE DE REFRIGERANT**

| REF            | OEM         |
|----------------|-------------|
| REC3F3-02305-1 | 3F3-02305-1 |

M60C  
M70C

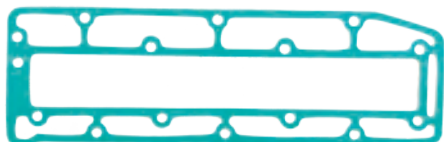

| REF            | OEM         |
|----------------|-------------|
| REC3B7-02305-1 | 3B7-02305-1 |

MD70B  
MD90D



**IMPULSORES**

**IMPELLERS**

**GIRANTE**

**TURBINES**

**GUÍA DE IMPULSORES**

**IMPELLER GUIDE**

**GUIDA GIRANTE**

**GUIDE DES TURBINES**

| 2T STROKES         | REF            | OEM         | CEF       | A (mm) | B (mm) | C (mm) |
|--------------------|----------------|-------------|-----------|--------|--------|--------|
| 2 / 2.5HP          |                | 369-65021-1 | CEF500377 | 10,25  | 33,6   | 14,3   |
| 2.5A/3.5A/3.5B     |                | 309-65021-1 | CEF500396 | 12     | 41     | 14     |
| 3.5 / 4 / 5 HP     |                | 369-65021-1 | CEF500377 | 10,25  | 33,6   | 14,3   |
| 6 / 8 / 9.8 HP     | REC3B2-65021-1 | 3B2-65021-1 | CEF500344 | 12,1   | 40     | 18     |
| 9.9 / 15 / 18 HP   |                | 334-65021-0 | CEF500383 | 13,96  | 40,7   | 23,35  |
| 25 / 30 / 35 HP    | REC345-65021-0 | 345-65021-0 | CEF500382 | 17,12  | 44,1   | 20,25  |
| 40 / 50 HP         |                | 345-65021-1 | CEF500379 | 17,2   | 50,4   | 20,15  |
| 60 / 70 / 90 HP    | REC3B7-65021-2 | 3B7-65021-2 | CEF500388 | 20,15  | 67,4   | 35,1   |
| 115 / 120 / 140 HP |                | 3C7-65021-1 | CEF500388 | 20,15  | -67,4  | 35,1   |

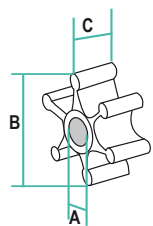

| 4T STROKES                | REF              | OEM            | CEF       | A (mm) | B (mm) | C (mm) |
|---------------------------|------------------|----------------|-----------|--------|--------|--------|
| MFS4, 5, 6HP              |                  | 369-65021-1    | CEF500377 | 10,25  | 33,6   | 14,3   |
| MFS8, 9.8 HP              | REC3B2-65021-1   | 3B2-65021-1    | CEF500344 | 12,1   | 40     | 18     |
| MFS9.9, 15, 18HP          |                  | 334-65021-0    | CEF500383 | 13,96  | 40,7   | 23,35  |
| 20HP                      |                  | 334-65021-0    | CEF500383 | 13,96  | 40,7   | 23,35  |
| MFS25, 30HP               | REC345-65021-0   | 345-65021-0    | CEF500382 | 17,12  | 44,1   | 20,25  |
| BFTW60A<br>BT60A          | REC19210-ZV5-003 | HZV5-19210-003 | CEF500338 | 17,20  | 55,90  | 20,20  |
| BFT115A / 150A            | REC19210-ZW1-B02 | HZW1-19210-B04 | CEF500337 | 23,35  | 87,80  | 31,00  |
| BFT200A / 225A<br>BFT250A | REC19210-ZY3-003 | HZY3-19210-003 | CEF500391 | 26     | 89,75  | 31,30  |



REC345-65021-0



REC3B2-65021-1

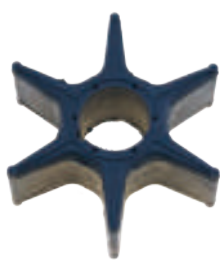

REC19210-ZY3-003



REC19210-ZV5-003



REC19210-ZW1-B02

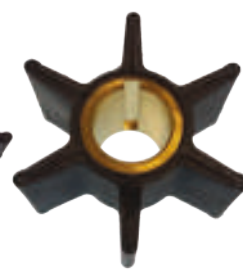

REC3B7-65021-2

**BOMBA DE AGUA**

**WATER PUMP**

**POMPA ACQUA**

**POMPE À EAU**

**JUNTA BASE DE BOMBA**

**WATER PUMP, GASKET BASE**

**GUARNIZIONE BASE POMPA**

**JOINT, BASE DE POMPE À EAU**

| REF   | OEM         |
|---|-------------|
| PAF8-04000007   | 3B2-65025-0 |
|  MD9.9D2 | MFS9.9B2-C  |
| MD15D2  | MFS15C      |
| MD18E2  | MFS18B2     |
|   | MFS20C      |



| REF  | OEM         |
|--|-------------|
| REC16159   | 369-65025-0 |
|  MFS4A2-B-C |             |
|  | MFS5A2-B-C  |
|  | MFS4A2-B-C  |



**JUNTAS BOMBA**

**WATER PUMP GASKET**

**GUARNIZIONE POMPA**

**JOINTS DE POMPE**

| REF  | OEM         |
|--|-------------|
| REC3F0-65029-0   | 3F0-65029-6 |
|  M3.2B2 |             |
|  | MFS2.5B     |
|  | MFS3.5B     |
|  | MFS2A       |



**CASQUILLO INOX**

**INSERT CUP**

**GHIERA INOX**

**INSERT INOX**

| REF  | OEM         |
|--|-------------|
| REC803751  | 350-65011-1 |
|  M9.9D2 |             |
|  | M15D2       |
|  | M18E2       |
|  | MFS9.9C, B2 |
|  | MSF15C, B2  |
|  | MSF20C      |
|  | MSF18B2     |

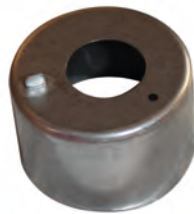

| REF  | OEM              |
|--|------------------|
| PAF8-04000010  | 3B2-65011-0      |
|  M6 |                  |
|  | M8               |
|  | M9.8B            |
|  | MFS8, A - A2 -A3 |
|  | MFS9.8A - A2 -A3 |



| REF   | OEM            |
|---|----------------|
| REC16157  | 369-65011-0    |
|  M4B |                |
|   | M5B            |
|   | M5B5           |
|   | MFS4, 5, 6 -A2 |



**KITS DE REPARACIÓN BOMBA DE AGUA**

**WATER PUMP SERVICE KITS**

**KIT RICAMBI POMPA ACQUA**

**KIT POMPE À EAU**

**new**

| REF  | OEM            |
|--|----------------|
| REC06192-ZY6-000   | HZY6-06192-000 |
|  BFT150 |                |
|  | BFT115A        |

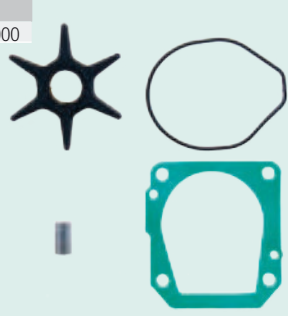

**new**

| REF   | OEM            |
|---|----------------|
| REC06192-ZY3-000  | HZY3-06192-000 |
|  BFT200A |                |
|   | BFT225A        |

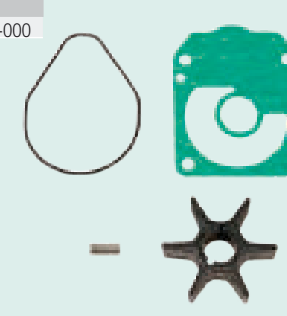



# ÁNODO

# ANODE

# ANODI

# ANODE

| ZN           | KG (KG) | AL            | KG (KG) | OEM         |
|--------------|---------|---------------|---------|-------------|
| CM3C760-2181 | 0,51    | CM3C760-2181A | 0,21    | 3C7760-2181 |

60, 70, 90, 120, 140 HP

| ZN            | KG (KG) | OEM         |
|---------------|---------|-------------|
| CM3B7-60218-0 | 0,51    | 3B7-60218-1 |

Serie MEGA

| ZN             | KG (KG) | AL              | KG (KG) | OEM          |
|----------------|---------|-----------------|---------|--------------|
| CM5338602182A0 | 0,21    | CM5338602182A0A | 0,08    | 5338602182A0 |

| ZN              | KG (KG) | AL               | KG (KG) | OEM         |
|-----------------|---------|------------------|---------|-------------|
| CM3H6-60218-000 | 0,03    | CM3H6-60218-000A | 0,01    | 3H6-60218-0 |

| ZN            | KG (KG) | OEM         |
|---------------|---------|-------------|
| CM3M2-60218-1 | 0,05    | 3M2-60218-0 |

40, 140 HP

| ZN           | KG (KG) | OEM         |
|--------------|---------|-------------|
| CM33860-2181 | 0,10    | 338-60218-2 |

2,5, 3,5, 5, 6, 8 HP  
15, 18, -S MAXI 25, 40  
CORSA

| ZN            | KG (KG) | AL             | KG (KG) | OEM       |
|---------------|---------|----------------|---------|-----------|
| CM3V1-60217-0 | 0,10    | CM3V1-60217-0A | 0,04    | 3V1602170 |

| ZN             | KG (KG) | OEM         |
|----------------|---------|-------------|
| CM348-60217-0M | 0,12    | 348-60217-0 |

Serie MAXI CORSA  
25-40 HP

| ZN            | KG (KG) | OEM         |
|---------------|---------|-------------|
| CM3C8-60217-0 | 0,15    | 3C8-60217-1 |

Serie MEGA  
25-50 HP

| ZN           | KG (KG) | OEM         |
|--------------|---------|-------------|
| CM3B7-602170 | 0,15    | 3B7-60217-0 |

60, 70, 90, 120, 140 HP

TOHATSU

RECAMBIOS MARINOS



ÁNODO

ANODE

ANODI

ANODE

| ZN       | KG<br>(KG) | OEM         |
|----------|------------|-------------|
| TEN01254 | 0,51       | 3C7-60218-2 |

Serie 60 - 70 - 90 -  
120 - 140 - 150 HP



| ZN       | KG<br>(KG) | OEM         |
|----------|------------|-------------|
| TEN01253 | 0,150      | 3C8-60217-1 |

Serie MEGA 25 - 50  
HP



| ZN       | KG<br>(KG) | OEM         |
|----------|------------|-------------|
| TEN01256 | 0,040      | 3B7-60218-1 |

Serie MEGA



| ZN       | KG<br>(KG) | OEM         |
|----------|------------|-------------|
| TEN01252 | 0,120      | 348-60217-0 |

Serie MAXI CORSA 25  
- 40 HP



| ZN       | KG<br>(KG) | OEM         | Ø     |
|----------|------------|-------------|-------|
| TEN01250 | 0,010      | 338-60218-2 | 20 mm |
| TEN01251 | 0,020      | 369-60218-1 | 24 mm |

Serie 2.5, 3.5, 5, 6, 8 HP  
15 - 18-S MAXI-25 - 40 CORSA



| ZN       | KG<br>(KG) | OEM         |
|----------|------------|-------------|
| TEN01255 | 0,320      | 3B7-60217-0 |

Serie 60 - 70 - 90 -  
120 - 140 HP



| ZN       | KG<br>(KG) | OEM         |
|----------|------------|-------------|
| TEN01257 | 0,050      | 3M2-60218-0 |

Serie 40 - 140 HP



| ZN       | KG<br>(KG) | OEM            |
|----------|------------|----------------|
| TEN01408 | 0,320      | HZV4-12155-A00 |

BFTW60A  
BFT60A  
BFT200A  
BFT250A  
BFT225A



new

| ZN       | KG<br>(KG) | OEM          |
|----------|------------|--------------|
| TEN01258 | 0,020      | 5338602182A0 |

Serie 40 - 140 HP



| ZN       | KG<br>(KG) | OEM         |
|----------|------------|-------------|
| TEN01259 | 0,030      | 3H6-60218-0 |



| ZN         | KG<br>(KG) | OEM            |
|------------|------------|----------------|
| TEN01408/1 | 0,320      | HZV5-12155-000 |

BFT60A  
BFT75AK1  
BFT90AK1  
BFT150A  
BFT200A  
BFT250A  
BFT225A  
BFT115A



new

| ZN       | KG<br>(KG) | OEM         |
|----------|------------|-------------|
| TEN01260 | 0,150      | 3B7-60217-0 |

Serie 140 HP



# PARTES DEL MOTOR ENGINE PARTS

# PARTI MOTORE PIECES MOTEUR

DESPIECE MOTOR  
DE 2 TIEMPOS

ENGINE PARTS  
2 STROKES

PARTI MOTORI  
2 TEMPI

PIECES DE MOTEURS  
2 TEMPS

2T  
STROKES M4C • M5B • M5BS

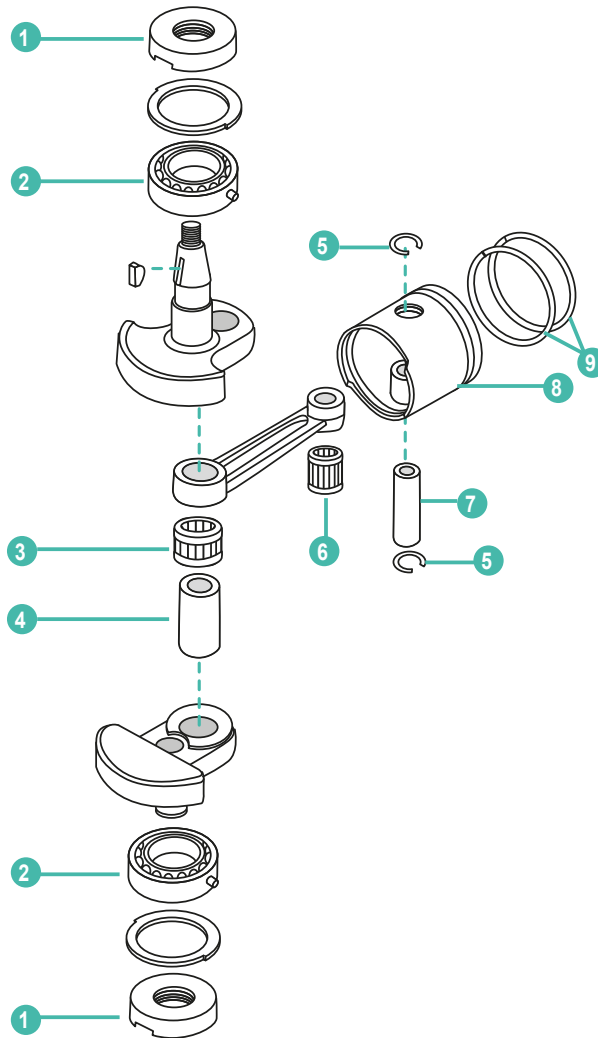

|   | REF          | OEM         |                   |                 |             |                 | UN. |
|---|--------------|-------------|-------------------|-----------------|-------------|-----------------|-----|
| 1 | REC26-16051  | 369-00122-0 | RETÉN ACEITE      | OIL SEAL        | PARALIO     | JOINT SPI       | 2   |
| 2 | REC30-16049  | 9603-3-6204 | RODAMIENTO        | BALL BEARING    | CUSCINETTO  | ROULEMENT       | 2   |
| 3 | REC31-813048 | 369-00043-0 | COJINETE DE AGUJA | NEEDLE BEARING  | CUSCINETTO  | ROULEMENT       | 1   |
| 4 | REC813046002 | 369-00061-0 | PIN               | CRANK PIN       | SPINOTTO    | PIN             | 1   |
| 5 | REC53-16057  | 350-00024-1 | CLIP              | CLIP            | CLIP        | CLIP            | 2   |
| 6 | REC31-16052  | 350-00042-0 | COJINETE DE AGUJA | NEEDLE BEARING  | CUSCINETTO  | ROULEMENT       | 1   |
| 7 | REC41-16056  | 369-00021-0 | PIN               | PISTON PIN      | SPINOTTO    | AXE DE PISTON   | 1   |
| 8 | REC779-9615T | 369-00001-0 | PISTÓN STD        | PISTON STD      | PISTONE STD | PISTON STD      | 1   |
| 9 | REC8M0080357 | 351-00011-0 | KIT SEGMENTOS     | PISTON RING KIT | KIT FASCIA  | KIT DE SEGMENTS | 2   |

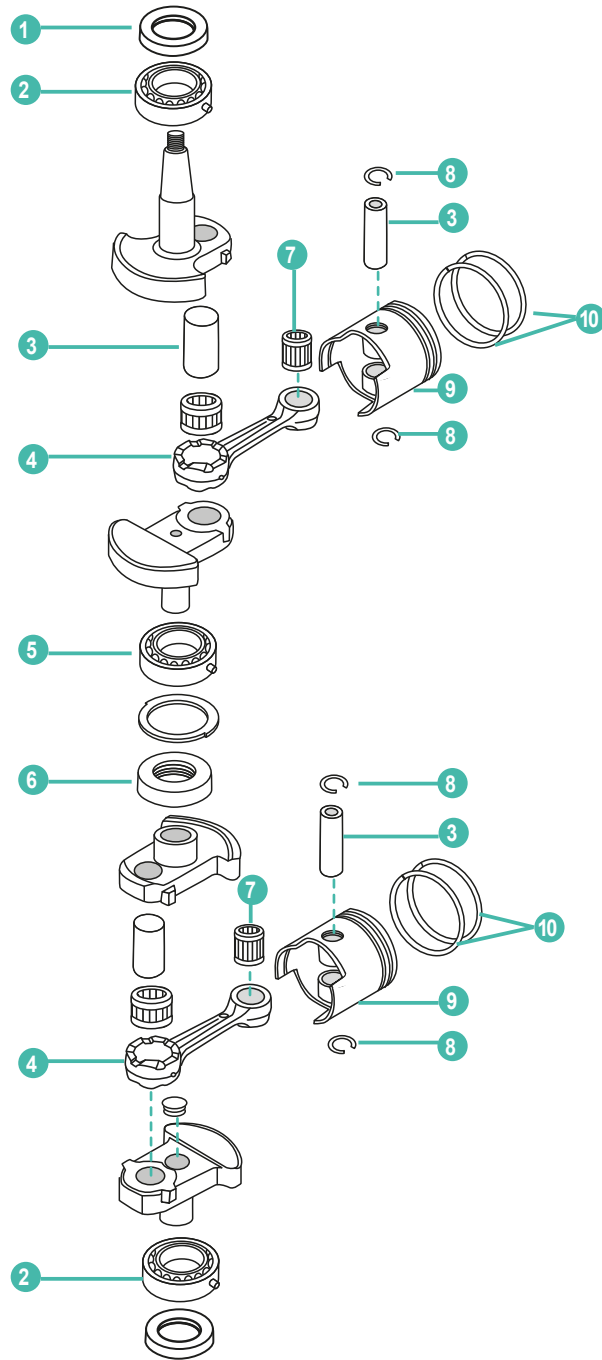

|    | REF            | OEM         |                   |                 |             |                 | UN. |
|----|----------------|-------------|-------------------|-----------------|-------------|-----------------|-----|
| 1  | REC26-803514   | 101-00121-0 | RETÉN ACEITE      | OIL SEAL        | PARALIO     | JOINT SPI       | 1   |
| 2  | REC30-16049    | 9603-3-6204 | RODAMIENTO        | BALL BEARING    | CUSCINETTO  | ROULEMENT       | 2   |
| 3  | REC41-8036801  | 3B2-00021-0 | PIN               | PISTON PIN      | SPINOTTO    | AXE DE PISTON   | 2   |
| 4  | REC629-8036741 | 3B2-00040-0 | BIELA             | CONNECTING ROD  | BIELLA      | BIELLE          | 2   |
| 5  | REC30-16049    | 9603-3-6204 | RODAMIENTO        | BALL BEARING    | CUSCINETTO  | ROULEMENT       | 1   |
| 6  | REC26-85370711 | 3B2-00051-0 | RETÉN ACEITE      | OIL SEAL        | PARALIO     | JOINT SPI       | 1   |
| 7  | REC31-8036752  | 338-00042-0 | COJINETE DE AGUJA | NEEDLE BEARING  | CUSCINETTO  | ROULEMENT       | 2   |
| 8  | REC53-16057    | 350-00024-1 | CLIP              | CLIP            | CLIP        | CLIP            | 2   |
| 9  | REC779-804886  | 3B2-00001-0 | PISTÓN STD        | PISTON STD      | PISTONE STD | PISTON STD      | 2   |
| 10 | REC39-803678A3 | 3B2-00011-0 | KIT SEGMENTOS     | PISTON RING KIT | KIT FASCIA  | KIT DE SEGMENTS | 4   |

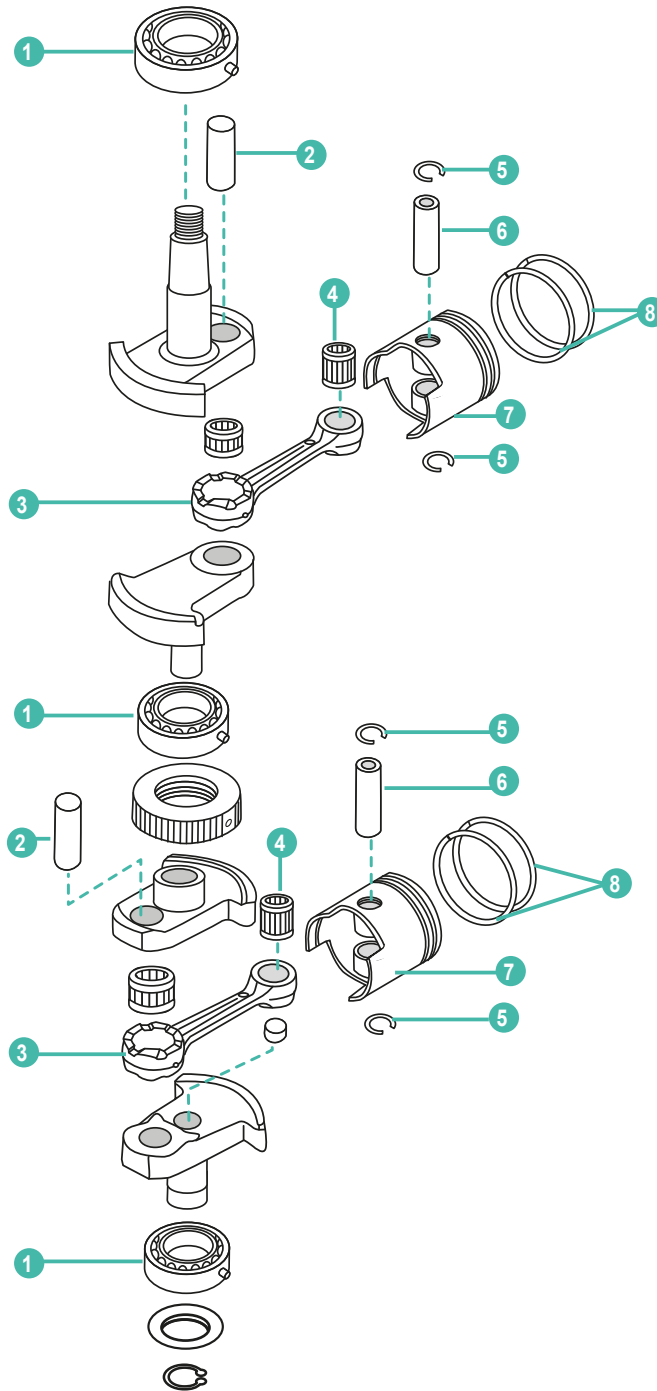

|   | REF              | OEM          |                           |                             |                         | UN.                         |   |
|---|------------------|--------------|---------------------------|-----------------------------|-------------------------|-----------------------------|---|
| 1 | REC30-160494     | 96603-3-6305 | RODAMIENTO                | BALL BEARING                | CUSCINETTO              | ROULEMENT                   | 3 |
| 2 | REC803673        | 350-00061-0  | PIN                       | CRANK PIN                   | SPINOTTO                | PIN                         | 2 |
| 3 | REC629-803674    | 350-00040-0  | BIELA                     | CONNECTING ROD              | BIELLA                  | BIELLE                      | 2 |
| 4 | REC31-16052      | 350-00042-0  | COJINETE DE AGUJA         | NEEDLE BEARING              | CUSCINETTO              | ROULEMENT                   | 2 |
| 5 | REC53-16057      | 350-00024-1  | CLIP                      | CLIP                        | CLIP                    | CLIP                        | 4 |
| 6 | REC41-803680002  | 350-00021-0  | PIN 18 HP                 | PISTON PIN 18 HP            | SPINOTTO 18 HP          | AXE DE PISTON 18 HP         | 2 |
|   | REC41-825713002  | 332-00021-0  | PIN 9.9 / 15 HP           | PISTON PIN 9.9 / 15 HP      | SPINOTTO 9.9 / 15 HP    | AXE DE PISTON 9.9 / 15 HP   | 2 |
| 7 | REC779-803677T02 | 351-00001-1  | PISTÓN STD, 9.9 / 15 HP   | PISTON STD 9.9 / 15 HP      | PISTONE STD 9.9 / 15 HP | PISTON STD 9.9 / 15 HP      | 1 |
|   | REC779-803677    | 350-00001-1  | PISTÓN STD 18 HPP         | PISTON STD HP               | PISTONE STD 18 HP       | PISTON STD 18 HP            | 1 |
| 8 | REC39-803678A1   | 350-00011-0  | KIT SEGMENTOS 18 HP       | PISTON RING KIT 18 HP       | KIT FASCIA 18 HP        | KIT DE SEGMENTS 18 HP       | 2 |
|   | REC8M0080357     | 351-00011-0  | KIT SEGMENTOS 9.9 / 15 HP | PISTON RING KIT 9.9 / 15 HP | KIT FASCIA 9.9 / 15 HP  | KIT DE SEGMENTS 9.9 / 15 HP | 2 |



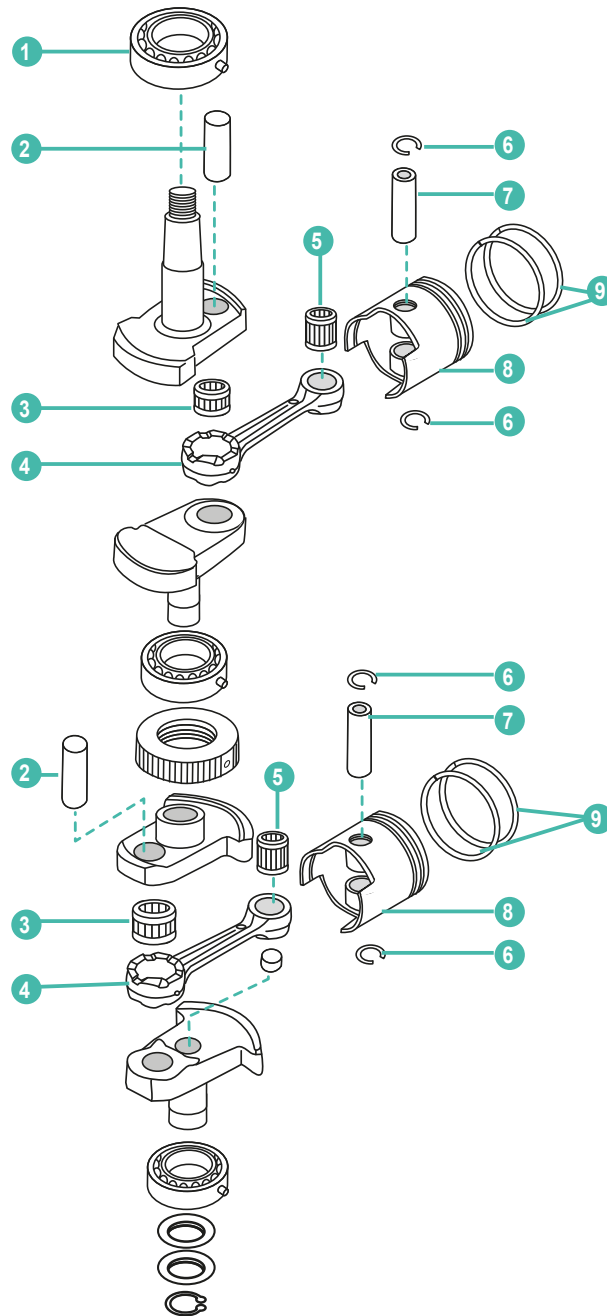

|   | REF              | OEM         |                   |                 |             |                 | UN. |
|---|------------------|-------------|-------------------|-----------------|-------------|-----------------|-----|
| 1 | REC30-16049T01   | 345-00113-0 | RODAMIENTO        | BALL BEARING    | CUSCINETTO  | ROULEMENT       | 1   |
| 2 | REC8130461       | 334-00061-0 | PIN               | CRANK PIN       | SPINOTTO    | PIN             | 2   |
| 3 | REC31-8130482    | 356-00043-0 | COJINETE DE AGUJA | NEEDLE BEARING  | CUSCINETTO  | ROULEMENT       | 2   |
| 4 | REC629-813047T01 | 336-00040-1 | BIELA             | CONNECTING ROD  | BIELLA      | BIELLE          | 2   |
| 5 | REC345-00042-0   | 345-00042-0 | COJINETE DE AGUJA | NEEDLE BEARING  | CUSCINETTO  | ROULEMENT       | 1   |
| 6 | REC53-16057      | 334-00024-1 | CLIP              | CLIP            | CLIP        | CLIP            | 4   |
| 7 | REC41-803680003  | 3C8-00021-0 | PIN               | PISTON PIN      | SPINOTTO    | AXE DE PISTON   | 2   |
| 8 | REC779-879194T01 | 346-00001-1 | PISTÓN STD        | PISTON STD      | PISTONE STD | PISTON STD      | 2   |
| 9 | REC39-16054A5    | 346-00011-0 | KIT SEGMENTOS     | PISTON RING KIT | KIT FASCIA  | KIT DE SEGMENTS | 4   |

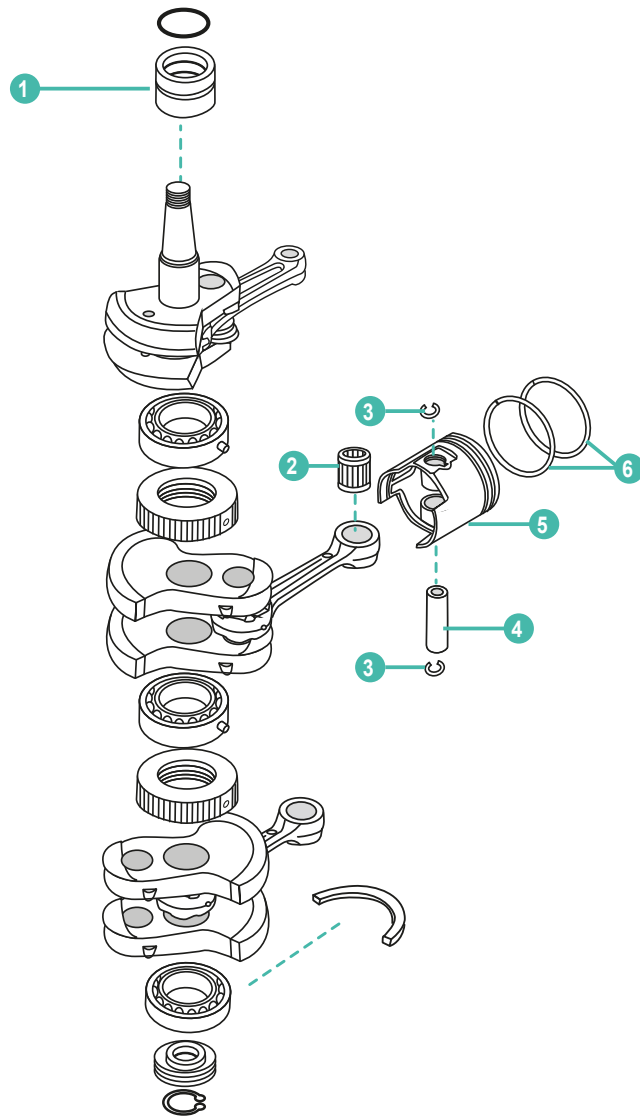

|   | REF            | OEM         |                   |                    |                      |                     | UN. |
|---|----------------|-------------|-------------------|--------------------|----------------------|---------------------|-----|
| 1 | REC31-855553   | 3C8-00113-0 | RODAMIENTO SUP.   | MAIN BEARING UPPER | CUSCINETTO SUPERIORE | ROULEMENT SUPERIEUR | 1   |
| 2 | REC345-00042-0 | 345-00042-0 | COJINETE DE AGUJA | NEEDLE BEARING     | CUSCINETTO           | ROULEMENT           | 3   |
| 3 | REC53-16057    | 334-00024-1 | CLIP              | CLIP               | CLIP                 | CLIP                | 6   |
| 4 | REC41-16056    | 3C8-00021-0 | PIN               | PISTON PIN         | SPINOTTO             | AXE DE PISTON       | 3   |
| 5 | REC779-9615T   | 3C8-00001-3 | PISTÓN STD        | PISTON STD         | PISTONE STD          | PISTON STD          | 3   |
| 6 | REC8M0080349   | 346-00011-0 | KIT SEGMENTOS     | PISTON RING KIT    | KIT FASCIA           | KIT DE SEGMENTS     | 6   |

DESPIECE MOTOR  
DE 4 TIEMPOS

ENGINE PARTS  
4 STROKES

PARTI MOTORI  
4 TEMPI

PIECES DE MOTEURS  
4 TEMPS

4T MFS8 • MFS9.9  
STROKES

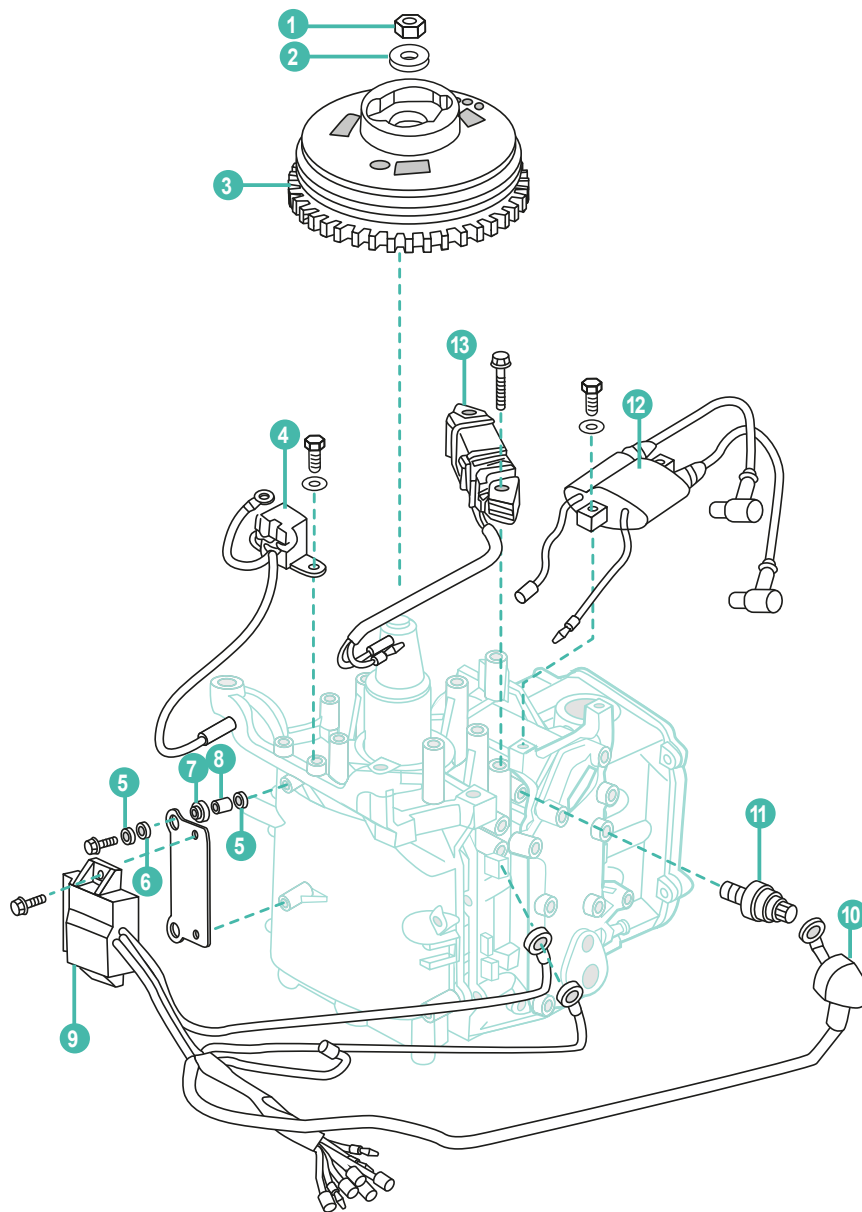

| REF | OEM            |             |                       |                      |                        |                           |
|-----|----------------|-------------|-----------------------|----------------------|------------------------|---------------------------|
| 1   | PAF8-05000024  | 369-00132-0 | TUERCA                | NUT, FLYWHEEL        | DADO                   | ÉCROIU                    |
| 2   | PAT15-04000011 | 940121-1200 | ARANDELA              | WASHER, FLYWHEEL NUT | RONDELLA               | RONDELLE                  |
| 3   | PAF8-050000600 | 3AA-06091-0 | EJE DE VOLANTE        | FLYWHEEL ASSY        | ASSE VOLANTE           | VOLANT MOTEUR             |
| 4   | PAF8-050000200 | 3V1-06071-0 | BOBINA PULSACIÓN      | COIL PULSER          | BOBINE ACCENSIONE      | BOBINE PULSEUR            |
| 5   | PAF8-050000021 | 3R0-66308-0 | ARANDELA              | WASHER               | RONDELLA               | RONDELLE                  |
| 6   | PAF8-050000007 | 3B7-06305-0 | AMORTIGUADOR (A)      | ABSORBER (A) CDI     | CUSCINO (A)            | SILENT BLOC (A)           |
| 7   | PAF8-050000011 | 3T5-06920-0 | AMORTIGUADOR (B)      | ABSORBER (B) CDI     | CUSCINO (B)            | SILENT BLOC (B)           |
| 8   | PAF8-050000006 | 3A0-76079-0 | MANGUERA              | TUBE                 | TUBO                   | DURITE                    |
| 9   | PAF8-050000400 | 3AA-06060-0 | CDI                   | CDI                  | CDI                    | CDI                       |
| 10  | PAF15-07010101 | 3H6-07612-0 | AISLANTE              | JACKET INSULATION    | ISOLANTE               | ISOLANT                   |
| 11  | PAF15-07010100 | 3H6-07611-0 | SENSOR PRESIÓN ACEITE | OIL PRESSURE SENSOR  | SENSORE PRESSIONE OLIO | SONDE DE PRESSION D'HUILE |
| 12  | PAF8-050000500 | 3V1-06040-0 | BOBINA ENCENDIDO      | STARTER COIL ASSY    | BOBINA AVVIAMENTO      | BOBINE DÉMARREUR          |
| 13  | PAF8-050000300 | 3AA-06021-0 | BOBINA                | COIL                 | BOBINE                 | COIL                      |

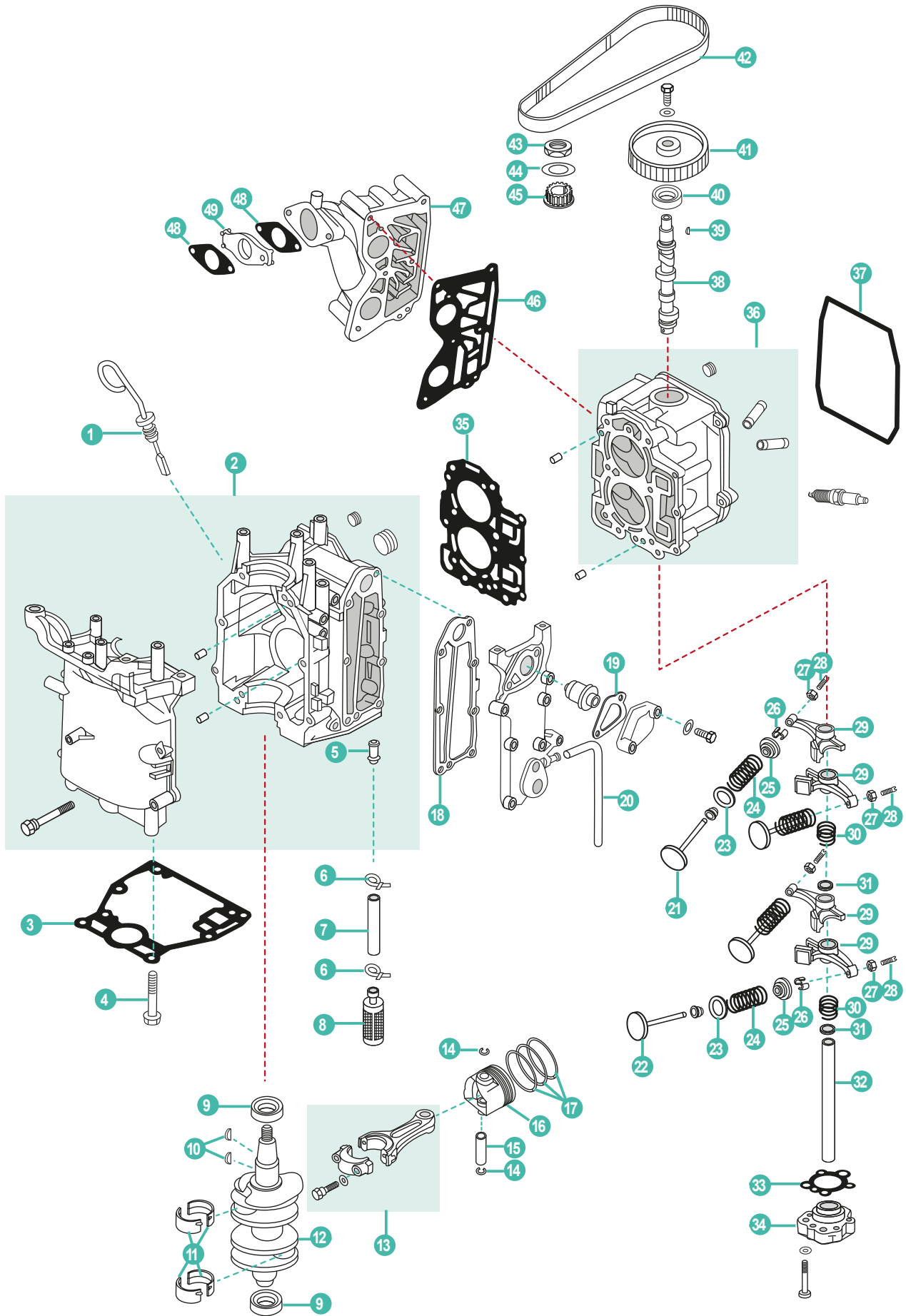

|    | REF             | OEM         |                       |                            |                               |                          |
|----|-----------------|-------------|-----------------------|----------------------------|-------------------------------|--------------------------|
| 1  | PAF8-0000200    | 3V1-07421-0 | MEDIDOR NIVEL ACEITE  | OIL LEVEL GAUGE            | MISURATORE LIVELLO OLIO       | JAUGE D'HUILE            |
| 2  | PAF8-05010000   | 3V1B01100-0 | BLOQUE COMPLETO       | CRANKCASSE ASSY            | BLOCCO MOTORE                 | MOTEUR COMPLET           |
| 3  | PAF8-00000004   | 3V1-01303-0 | JUNTA BASE MOTOR      | GASKET, ENGINE BASEMENT    | GUARNIZIONE BASE MOTORE       | JOINT, BASE DE MOTEUR    |
| 4  | PAF8-00000003   | 3R3-61017-0 | TORNILLO M8x35        | BOLT M8x35                 | VITE M8x35                    | VIS M8x35                |
| 5  | PAF8-05010002   | 3H8-02093-0 | RACORD                | NIPPLE                     | RACCORDO                      | RACORD                   |
| 6  | PAF8-05000025   | 369-84398-0 | CLIP                  | HOOP                       | CLIP                          | CLIP                     |
| 7  | PAF8-05000017   | 98AH10-0120 | MANGUERA              | HOSE                       | TUBO                          | DURITE                   |
| 8  | PAF8-05000800   | 3V1-07410-0 | FILTRO ACEITE         | OIL STRAINER               | FILTRO OLIO                   | FILTRE A HUILE           |
| 9  | PAF8-05010012   | 3V1-00121-0 | RETÉN ACEITE          | OIL SEAL                   | PARAOLIO                      | JOINT SPI                |
| 10 | PAF4-04000019   | 3T5-10131-0 | CHAVETA               | KEY                        | CHIAVETTA                     | CLAVETTE                 |
| 11 | PAF8-05010009   | 3V1-07407-0 | COJINETE              | BUSH                       | BRONZINA                      | ROULEMENT                |
| 12 | PAF8-05020001   | 3V1-00030-1 | CIGÜEÑAL              | CRANK                      | ALBERO MOTORE                 | VILEBREQUIN              |
| 13 | PAF8-05020200   | 3V1-00040-0 | BIELA                 | CONNENCTING ROD            | BIELLA                        | BIELLE                   |
| 14 | PAF15-07020005  | 350-00024-1 | CLIP                  | CIRCLIP                    | CLIP                          | CLIP                     |
| 15 | PAF8-05020105   | 332-00021-0 | PIN                   | PIN, PISTON                | SPINNOTO                      | AXE DE PISTON            |
| 16 | PAF8-05020101   | 3V1-00001-0 | PISTON                | PISTON                     | PISTONE                       | PISTON                   |
| 17 | REC39-8M0055809 | 3V1-00011-0 | KIT SEGMENTOS         | PISTON RING KIT            | KIT FASCIA                    | KIT DE SEGMENTS          |
| 18 | PAF8-05010004   | 3V1-02305-0 | JUNTA ESCAPE          | GASKET, EXHAUST COVER      | GUARNIZIONE SCARICCO          | JOINT D'ECHAPPEMENT      |
| 19 | PAF8-05010005   | 346-01032-0 | JUNTA TERMOSTATO      | GASKET, THERMOSTAT COVER   | GUARNIZIONE TERMOSTATO        | JOINT DE THERMOSTAT      |
| 20 | PAF8-05000024   | 98AB-5-0330 | TUBO                  | WATER PIPE                 | TUBO                          | DURITE                   |
| 21 | PAF8-05030001   | 3V1-07201-0 | VÁLVULA ADMISIÓN      | VALVE INTAKE               | VALVOLA ASPIRAZIONE           | SOUPAPE D'ADMISSION      |
| 22 | PAF8-05030002   | 3V1-07202-0 | VÁLVULA ESCAPE        | VALVE EXHAUST              | VALVOLA SCARICO               | SOUPAPE D'ECHAPPEMENT    |
| 23 | PAF8-05030004   | 3V1-07205-0 | ASIENTO MUELLE        | SEAL, VALVE SPRING         | SIGILLO MOLLA                 | SIEGE RESSORT DE SOUPAPE |
| 24 | PAF8-05030005   | 3AA-07203-0 | MUELLE VÁLVULA        | SPRING VALVE               | VALVOLA MOLLA                 | RESSORT DE SOUPAPE       |
| 25 | PAF8-05030006   | 3V1-07221-0 | RETEN RESORTE         | RETAINER, VALVE SPRINGER   | VALVOLA DI RITEGNO            | JOINT DE RESSORT         |
| 26 | PAF8-05030007   | 3H6-07223-0 | SEGURO DE VÁLVULA     | CLAMP, VALVE               | BLOCCAGGIO DI VALVOLA         | CLAVETTE DE SOUPAPE      |
| 27 | PAF15-07040304  | 3H8-07237-0 | TUERCA                | LOCK NUT                   | GHIERA                        | ÉCROU                    |
| 28 | PAF15-07040303  | 3R0-07238-0 | TORNILLO AJUSTE       | SCREW, VALVE ADJUSTING     | VITE                          | VIS                      |
| 29 | PAF8-05030200   | 3V1-07235-0 | BALANCÍN              | ROCKER                     | BILANCERE                     | CULBUTEUR                |
| 30 | PAF8-05030009   | 3AA-07225-0 | MUELLE                | SPRING ROCKER              | MOLLA                         | RESSORT                  |
| 31 | PAF8-05030015   | 3R3-07227-0 | ARANDELA              | BUSHER, ROCKER SPRING      | RONDELLA                      | RONDELLE                 |
| 32 | PAF8-005030010  | 3H8-07226-0 | EJE                   | SHAFT ROCKER               | ASSE                          | AXE DE CULBUTEUR         |
| 33 | PAF8-05030012   | 3V1-07653-0 | JUNTA BOMBA ACEITE    | OIL PUMP GASKET            | GUARNIZIONE POMPA OLIO        | JOINT POMPE              |
| 34 | PAF8-05030300   | 3V1-07600-0 | BOMBA ACEITE          | OIL PUMP                   | POMPA OLIO                    | POMPE À HUILE            |
| 35 | PAF8-05000100   | 3V1-02305-0 | JUNTA CULATA          | CYLINDER HEAD GASKET       | GUARNIZIONE TESTATA           | JOINT DE CULASSE         |
| 36 | PAF8-05030100   | 3V1B01001-0 | CULATA                | CYLINDER HEAD ASSY         | TESTATA                       | CULASSE                  |
| 37 | PAF8-05000002   | 3V1-01024-0 | JUNTA TAPA CULATA     | CYLINDER HEAD COVER GASKET | GUARNIZIONE COPERCHIO TESTATA | JOINT COUVERCLE          |
| 38 | PAF8-05030008   | 3V1-07010-0 | ÁRBOL DE LEVAS        | CRAMSHAFT                  | ALBERO MOTORE                 | ARBRE À CAMES            |
| 39 | PAT3.6-04000006 | 309-00131-0 | CHAVETA               | KEY                        | CHIAVETTA                     | CLAVETTE                 |
| 40 | PAF8-05030011   | 3H8-07025-0 | RETÉN ACEITE          | OIL SEAL 18x35x7.8 mm      | PARAOLIO                      | JOINT SPI                |
| 41 | PAF8-05030400   | 3H8-10062-2 | POLEA                 | DRIVER PULLEY              | PULEGGIA                      | POULIE                   |
| 42 | PAF8-05000004   | 3V1-10045-0 | CORREA                | TIMING BELT                | CINGHIA DI DISTRIBUZIONE      | COURROIR DISTRIBUTION    |
| 43 | PAF8-05010016   | 3V1-10068-0 | TUERCA                | NUT                        | DADO                          | ÉCROU                    |
| 44 | PAF8-05010015   | 3V1-10063-0 | ARANDELA              | BELT GUIDER                | RONDELLA                      | RONDELLE                 |
| 45 | PAF8-05010014   | 3V1-10060-0 | POLEA                 | DRIVER PULLEY              | PULEGGIA                      | POULIE                   |
| 46 | PAF8-05000009   | 3V1-02104-0 | JUNTA COLECTOR        | GASKET MANIFOLD            | GUARNIZIONE COLLETTORE        | JOINT DE COLLECTEUR      |
| 47 | PAF8-05000008   | 3V1-02010-1 | COLECTOR ADMISIÓN     | INTAKE MANIFOLD            | COLLETTORE ASPIRAZIONE        | COLLECTEUR D'ADMISSION   |
| 48 | PAF15-07000017  | 3V1-02011-0 | JUNTA CARBURADOR      | GASKET CARBURETOR          | GUARNIZIONE CARBURATORE       | JOINT CARBURATEUR        |
| 49 | PAF15-07000018  | 3V1-03952-0 | SEPARADOR, CARBURADOR | INSULATOR, CARBURETOR      | ISOLANTE, CARBURATORE         | ISOLANT CARBURATEUR      |



4T MFS8 • MFS9.9  
STROKES

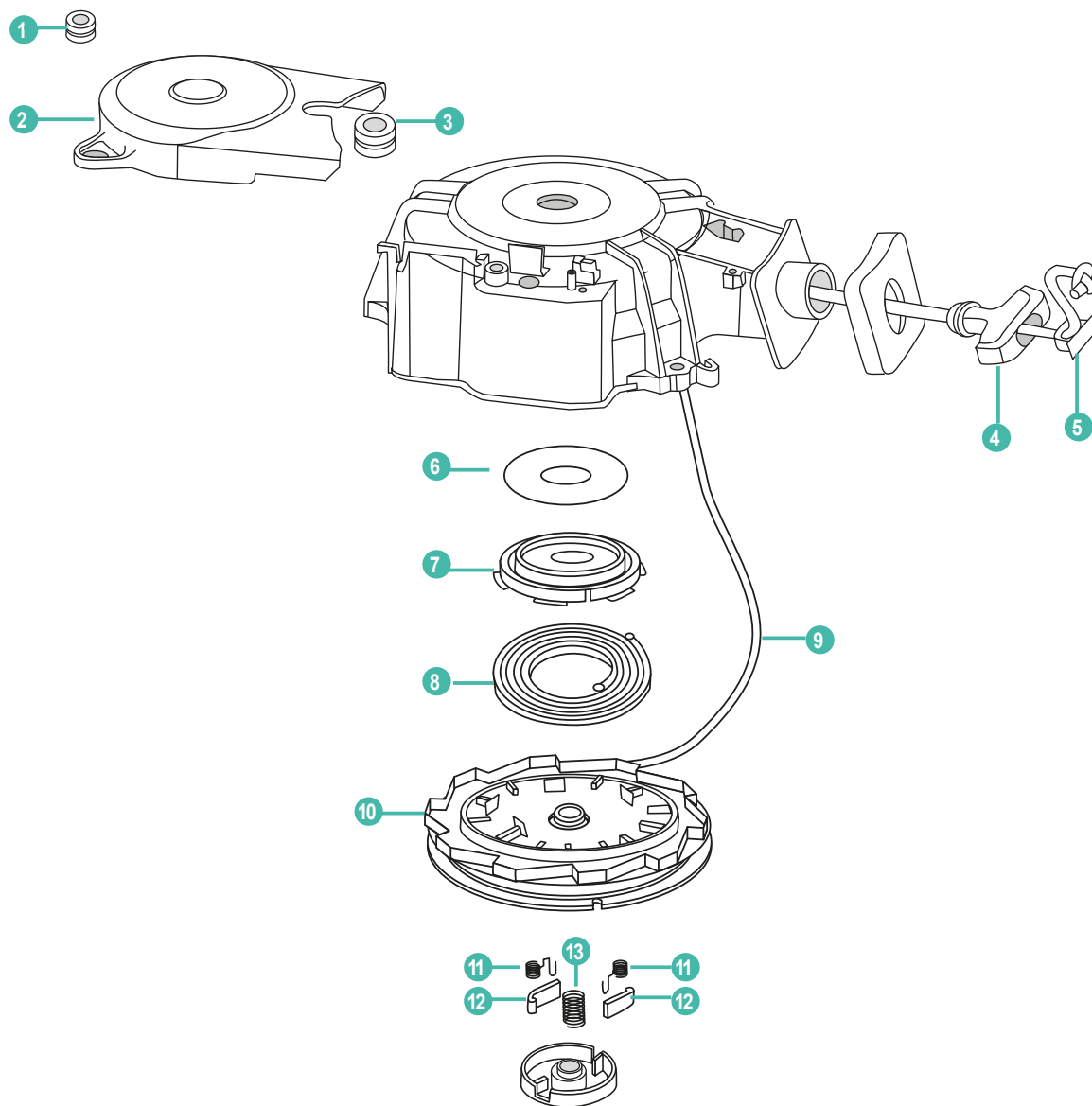

|    | REF           | OEM         |              |                  |                     |
|----|---------------|-------------|--------------|------------------|---------------------|
| 1  | PAF8-0500003  | 172-36008-0 | RETÉN        | RUBBER GROMMET A | TENUTA              |
| 2  | PAF8-0500012  | 3V1-06308-0 | TAPA         | COVER, STRAP     | COPERCHIO           |
| 3  | PAF8-0500013  | 3V1-06302-0 | RETÉN        | RUBBER GROMMET B | TENUTA              |
| 4  | PAF4-04130101 | 3AA-05019-0 | TIRADOR      | HANDLE, STARTER  | MANIGLIA AVVIAMENTO |
| 5  | PAF4-04130102 | 3R1-05131-0 | TAPA         | COVER, HANDLE    | COPERCHIO           |
| 6  | PAF8-05050002 | 3V1-05259-0 | ARANDELA     | WASHER, THRUST   | RONDELLA            |
| 7  | PAF8-05050003 | 3R1-05125-0 | MUELLE       | SPRING CASE      | MOLLA               |
| 8  | PAF8-05050004 | 3AA-05004-0 | MUELLE       | VOLUTE SPRING    | MOLLA               |
| 9  | PAF8-05050018 | 3AA-05013-0 | CUERDA       | START LINE       | CORDA DI AVVIAMENTO |
| 10 | PAF8-05050005 | 3V1-05104-1 | VOLANTE      | WHELL, START-UP  | VOLANTE             |
| 11 | PAF8-05050007 | 3R1-05012-0 | MUELLE       | SPRING, TENSIÓN  | MOLLA               |
| 12 | PAF8-05050006 | 3R1-05003-1 | UÑA PLÁSTICA | PAWL, DRIVE      | NOTTOLINO           |
| 13 | PAF8-05050009 | 3R1-05007-0 | MUELLE       | SPRING PLATE     | MOLLA               |
|    |               |             |              |                  | JOINT               |
|    |               |             |              |                  | COUVERCLE           |
|    |               |             |              |                  | JOINT               |
|    |               |             |              |                  | POIGNEE DE LANCEUR  |
|    |               |             |              |                  | COUVERCLE           |
|    |               |             |              |                  | RONDELLE            |
|    |               |             |              |                  | RESSORT             |
|    |               |             |              |                  | RESSORT             |
|    |               |             |              |                  | CORDA DE LANCEUR    |
|    |               |             |              |                  | VOLANT              |
|    |               |             |              |                  | RESSORT             |
|    |               |             |              |                  | RESSORT             |
|    |               |             |              |                  | CLIQUET             |
|    |               |             |              |                  | RESSORT             |

**JUNTAS DE MOTOR  
4 TIEMPOS**

**ENGINE GASKET  
4 STROKES**

**GUARNIZIONI  
MOTORE 4 TEMPI**

**JOINTS DE MOTEUR  
4 TEMPS**

**JUNTAS DE CULATA**

**CYLINDER HEAD GASKET**

**GUARNIZIONE DE TESTATA**

**JOINT DE CULASSE**

| REF            | OEM         |
|----------------|-------------|
| REC309-01005-2 | 309-01005-2 |

 M2.5  
 M2.5A  
 M2.5A2  
 M3.5A  
 M3.5A2



| REF            | OEM         |
|----------------|-------------|
| REC346-01005-0 | 346-01005-0 |

 M25C3  
 M30A4



| REF            | OEM         |
|----------------|-------------|
| REC3B2-01005-0 | 3B2-01005-0 |

 M6B  
 M8B  
 M9.8B



| REF            | OEM         |
|----------------|-------------|
| REC3C8-01005-4 | 3C8-01005-4 |

 M40D2  
 M50D2



| REF            | OEM         |
|----------------|-------------|
| REC351-01005-0 | 351-01005-0 |

 M9.9D  
 M15D  
 M9.9D2  
 M15D2



| REF            | OEM         |
|----------------|-------------|
| REC3F3-01005-0 | 3F3-01005-0 |

 M60C  
 M70C



| REF            | OEM         |
|----------------|-------------|
| REC350-01005-0 | 350-01005-0 |

 M18E2



| REF            | OEM         |
|----------------|-------------|
| REC3T9-01005-0 | 3T9-01005-0 |

 MD70  
 MD90

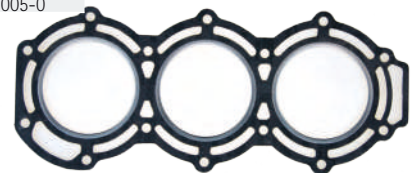

**KITS  
JUNTAS DE CULATA**

**CYLINDER HEAD GASKET  
KIT**

**KIT  
GUARNIZIONE TESTATA**

**KITS  
JOINTS MOTEUR**

| REF            | OEM         |
|----------------|-------------|
| REC3T5-87121-6 | 3T5-87121-6 |

 MD40B2  
 MD50B2

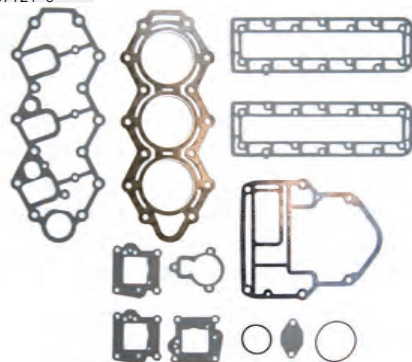

| REF            | OEM         |
|----------------|-------------|
| REC3B7-87121-1 | 3B7-87121-7 |

 M80A  
 M90A

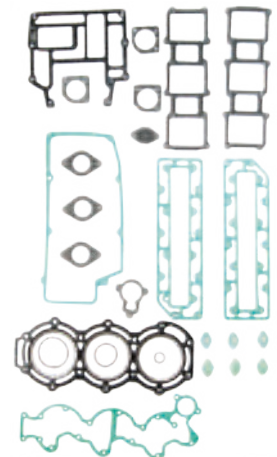

**JUNTAS DE CULATÍN**

**GASKET, HEAD COVER**

**GUARNIZIONE COPERCHIO  
TESTA**

**JOINTS DE COUVRE  
CULASSE**

| REF            | OEM         |
|----------------|-------------|
| REC3C8-01024-0 | 3C8-01024-0 |

 M40D2  
 M50D2



| REF            | OEM         |
|----------------|-------------|
| REC3F3-01024-0 | 3F3-01024-0 |

 M60C  
 M70C



**JUNTAS BASE DE MOTOR**

**CYLINDER GASKET**

**GUARNIZIONE  
BASE MOTORE**

**JOINTS DE TÊTE MOTRICE**

| REF            | OEM         |
|----------------|-------------|
| REC350-01303-0 | 350-01303-0 |

-  M9.9D2
- M15D2
- M18E2

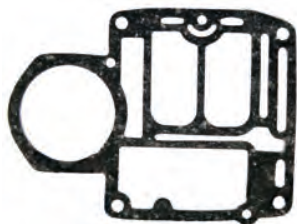

| REF            | OEM         |
|----------------|-------------|
| REC3C8-01303-4 | 3C8-01303-4 |

-  MD40B
- MD50B

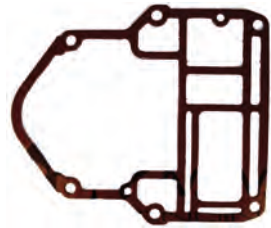

| REF            | OEM         |
|----------------|-------------|
| REC350-61012-1 | 350-61012-1 |

-  M9.9D2
- M15D2
- M18E2

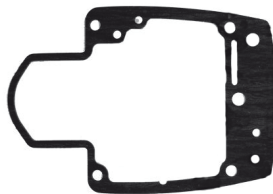

| REF            | OEM         |
|----------------|-------------|
| REC3F3-01303-1 | 3F3-01303-1 |

-  M60C
- M70C



| REF            | OEM         |
|----------------|-------------|
| REC346-01303-0 | 350-01303-0 |

-  M25C3
- M30A4

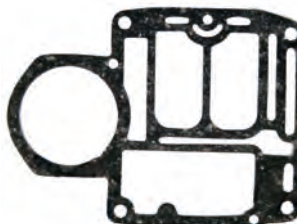

| REF            | OEM         |
|----------------|-------------|
| REC3B2-01303-0 | 3B2-01303-0 |

-  M6B
- M8B
- M9.8B

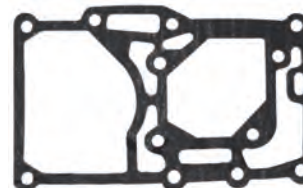

**RETENES DE ACEITE OIL SEALS**

**PARAOLIO**

**JOINT SPI**

**RETÉN DE ACEITE**

**OIL SEAL**

**PARAOLIO**

**JOINT SPI**

| REF           | OEM         |  |
|---------------|-------------|---|
| REC26-8537072 | 346-01215-0 | 18 x 28 x 6 mm  |

-  M25C3
- M30A4
- MFS25A-B
- MFS30A-B
- MFS40A
- MFS50A



| REF          | OEM         |  |
|--------------|-------------|---|
| REC26-161301 | 346-60111-0 | 18 x 28 x 8 mm  |

-  M25C3
- M30A4
- MFS30A - B
- MFS25A - B



| REF          | OEM         |  |
|--------------|-------------|---|
| REC26-161622 | 346-65013-0 | 17 x 30 x 9 mm  |

-  M15D2
- M18E2
- M25C3
- M30A4
- M9.9D2
- MFS20C
- MFS18B2
- MFS15C-B2
- MFS30B-A
- MFS25A-B
- MFS20C
- MFS9.9B2-C



| REF          | OEM         |  |
|--------------|-------------|---|
| REC26-803667 | 350-00121-0 | 25 x 45 x 8 mm  |

-  M9.9D2
- M15D2
- M18E2



| REF          | OEM         |  |
|--------------|-------------|---|
| REC8M0065585 | 350-01215-5 | 25 x 69 x 9,5 mm  |

-  M9.9D2
- M15D2
- M18E2



| REF         | OEM         |  |
|-------------|-------------|---|
| REC26-16703 | 369-01215-0 | 10 x 62 x 7 mm  |

-  M4C
- M5B
- M5BS
- MFS4A-B / 5A-B-C / 6A-B-C



| REF         | OEM         |  |
|-------------|-------------|---|
| REC26-16162 | 369-60223-0 | 10 x 24 x 8 mm  |

-  M4C
- M5B
- M5BS
- MFS4A-B / 5A-B-C / 6A-B-C



# CIGÜEÑAL

# CRANKSHAFT

# ALBERO MOTORE

# VILEBREQUIN

## RODAMIENTOS DE CIGÜEÑAL

## CRANKSHAFT BEARINGS

## CUSCINETTI ALBERO MOTORE ROULEMENTS VILEBREQUIN

SUPERIOR | UPPER | SUPERIORE | SUPERIEUR

| REF             | OEM         |
|-----------------|-------------|
| REC30-898101936 | 9643-3-6004 |

M2.5A  
M3.5A-B



INFERIOR | UNDER | INFERIORE | INFERIEUR

| REF         | OEM         |
|-------------|-------------|
| REC30-95307 | 9643-3-6202 |

M2.5A  
M3.5A-B



# PISTONES

# PISTONS

# PISTONI

# PISTONS

## KITS DE PISTONES

## PISTON KITS

## KIT PISTONE

## KIT PISTON

|                 | STD         | OEM |
|-----------------|-------------|-----|
| REF             |             |     |
| REC779-803677   | 350-00001-0 |     |
| REC8M0080357    | 351-00011-0 |     |
| REC629-803674   | 350-00040-0 |     |
| REC41-825713002 | 332-00021-0 |     |
| REC53-16057     | 350-00024-1 |     |
| REC31-16052     | 350-00042-0 |     |

M9.9D2  
M15D2 (2 Cyl)



|              | STD         | OEM |
|--------------|-------------|-----|
| REF          |             |     |
| REC779-9615T | 369-00001-0 |     |
| REC8M0080357 | 351-00011-0 |     |
| REC41-16056  | 369-00021-0 |     |
| REC53-16057  | 350-00024-1 |     |
| REC31-16052  | 350-00042-0 |     |

M4C  
M5B  
M5BS (1 Cyl)



|                  | STD         | OEM |
|------------------|-------------|-----|
| REF              |             |     |
| REC779-803677T02 | 351-00001-1 |     |
| REC629-803674    | 350-00040-0 |     |
| REC41-803680002  | 350-00021-0 |     |
| REC53-16057      | 350-00024-1 |     |
| REC31-16052      | 350-00042-0 |     |

M18E2 (2 Cyl)



|                | STD         | OEM |
|----------------|-------------|-----|
| REF            |             |     |
| REC779-804886  | 3B2-00001-0 |     |
| REC39-803678A3 | 3B2-00011-0 |     |
| REC629-8036741 | 3B2-00040-0 |     |
| REC41-8036801  | 3B2-00021-0 |     |
| REC53-16057    | 350-00024-1 |     |
| REC31-8036752  | 338-00042-0 |     |

M6B  
M8B  
M9.8B (2 Cyl)





|   | STD              |             |
|---|------------------|-------------|
|   | REF              | OEM         |
|  | REC779-879194T01 | 346-00001-1 |
|  | REC39-16054A5    | 346-00011-0 |
|  | REC629-813047T01 | 336-00040-1 |
|  | REC41-803680003  | 3C8-00021-0 |
|  | REC53-16057      | 350-00024-1 |
|  | REC345-00042-0   | 345-00042-0 |

 M25C3  
M30A4 (2 Cyl)



|   | STD             |                            |
|---|-----------------|----------------------------|
|   | REF             | OEM                        |
|  | REC779-96152    | 3C8-00001-3                |
|  | REC8M0080349    | 356-00011-0<br>346-00011-0 |
|  | REC629-8036741  | 3B2-00040-0                |
|  | REC41-803680003 | 3C8-00021-0                |
|  | REC53-16057     | 334-00024-1                |
|  | REC345-00042-0  | 345-00042-0                |

 M40D2  
M50D2 (3 Cyl)



|   | STD            |             |
|---|----------------|-------------|
|   | REF            | OEM         |
|   | PAF8-05020101  | 3V1-00001-0 |
|  | PAF8-05020200  | 3V1-00040-0 |
|  | PAF8-05020105  | 332-00024-0 |
|  | PAF15-07020005 | 350-00024-1 |

 MFS8  
MFS9.8A-A2-A3 (2 Cyl)





**P 51**

REF  
CRA904633  
CRA946331



REF  
SSP4213

**P 51**



# SISTEMA DE ESCAPE Y ADMISIÓN EXHAUST & INTAKE SYSTEM

# SISTEMA DI SCARICO E ASPIRAZIONE SYSTÈME D'ÉCHAPPEMENT ET D'ADMISSION

| SISTEMA DE ESCAPE | EXHAUST SYSTEM | SISTEMA SCARICO | SYSTÈME D'ÉCHAPPEMENT |
|-------------------|----------------|-----------------|-----------------------|
|-------------------|----------------|-----------------|-----------------------|

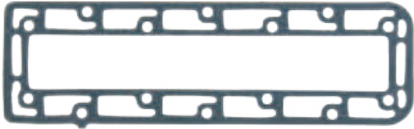

| JUNTAS DE ESCAPE | GASKET, EXHAUST | GUARNIZIONE SCARICO | JOINTS D'ÉCHAPPEMENT |
|------------------|-----------------|---------------------|----------------------|
|------------------|-----------------|---------------------|----------------------|

| <table border="1"> <tr> <th>REF</th> <th>OEM</th> </tr> <tr> <td>REC3C8-02305-0</td> <td>3C8-02305-0</td> </tr> </table> <p>M40D2 / B<br/>M50D2 / B</p> | REF         | OEM | REC3C8-02305-0 | 3C8-02305-0 |  |  |  |
|---|-------------|-----|----------------|-------------|---|--|--|
| REF   | OEM         |     |                |             |   |  |  |
| REC3C8-02305-0  | 3C8-02305-0 |     |                |             |   |  |  |

| SISTEMA DE ADMISIÓN | INTAKE SYSTEM | SISTEMA ASPIRAZIONE | SYSTÈME D'ADMISSION |
|---------------------|---------------|---------------------|---------------------|
|---------------------|---------------|---------------------|---------------------|

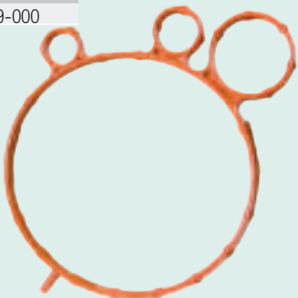
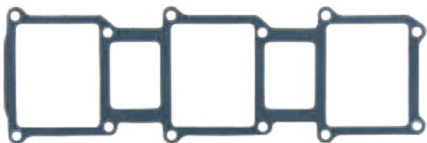
| JUNTAS DE ADMISIÓN | GASKET, INTAKE | GUARNIZIONE ASPIRAZIONE | JOINTS D'ADMISSION |
|--------------------|----------------|-------------------------|--------------------|
|--------------------|----------------|-------------------------|--------------------|

| <table border="1"> <tr> <th>REF</th> <th>OEM</th> </tr> <tr> <td>REC17109-ZY6-000</td> <td>HZY6-17109-000</td> </tr> </table> <p>BFT90AK1<br/>BFT75AK1<br/>BFT115A<br/>BFT150A</p> | REF            | OEM | REC17109-ZY6-000 | HZY6-17109-000 |  | <table border="1"> <tr> <th>REF</th> <th>OEM</th> </tr> <tr> <td>REC3T9-02104-0</td> <td>3T9-02104-0</td> </tr> </table> <p>MD70B<br/>MD90B</p> | REF | OEM | REC3T9-02104-0 | 3T9-02104-0 |  |
|--|----------------|-----|------------------|----------------|---|---|-----|-----|----------------|-------------|---|
| REF  | OEM            |     |                  |                |   |   |     |     |                |             |   |
| REC17109-ZY6-000   | HZY6-17109-000 |     |                  |                |   |   |     |     |                |             |   |
| REF  | OEM            |     |                  |                |   |   |     |     |                |             |   |
| REC3T9-02104-0   | 3T9-02104-0    |     |                  |                |   |   |     |     |                |             |   |

| <table border="1"> <tr> <th>REF</th> <th>OEM</th> </tr> <tr> <td>REC3C8-02104-0</td> <td>3C8-02104-0</td> </tr> </table> <p>M40D2<br/>M50D2</p> | REF         | OEM | REC3C8-02104-0 | 3C8-02104-0 |  | <table border="1"> <tr> <th>REF</th> <th>OEM</th> </tr> <tr> <td>REC3F3-02104-0</td> <td>3F3-02104-0</td> </tr> </table> <p>M60C<br/>M70C</p> | REF | OEM | REC3F3-02104-0 | 3F3-02104-0 |  |
|---|-------------|-----|----------------|-------------|---|---|-----|-----|----------------|-------------|---|
| REF   | OEM         |     |                |             |   |   |     |     |                |             |   |
| REC3C8-02104-0  | 3C8-02104-0 |     |                |             |   |   |     |     |                |             |   |
| REF   | OEM         |     |                |             |   |   |     |     |                |             |   |
| REC3F3-02104-0  | 3F3-02104-0 |     |                |             |   |   |     |     |                |             |   |

# UNIDADES DE TRANSMISIÓN UNIT DRIVES & COMPONENTS

# UNITÀ DI TRASMISSIONE EMBASES ET PIÈCES

DESPIECE COLAS

GEAR CASE PARTS

PARTI PIEDI

PIECES D'EMBASES

4T MFS8 • MFS9.8  
STROKES

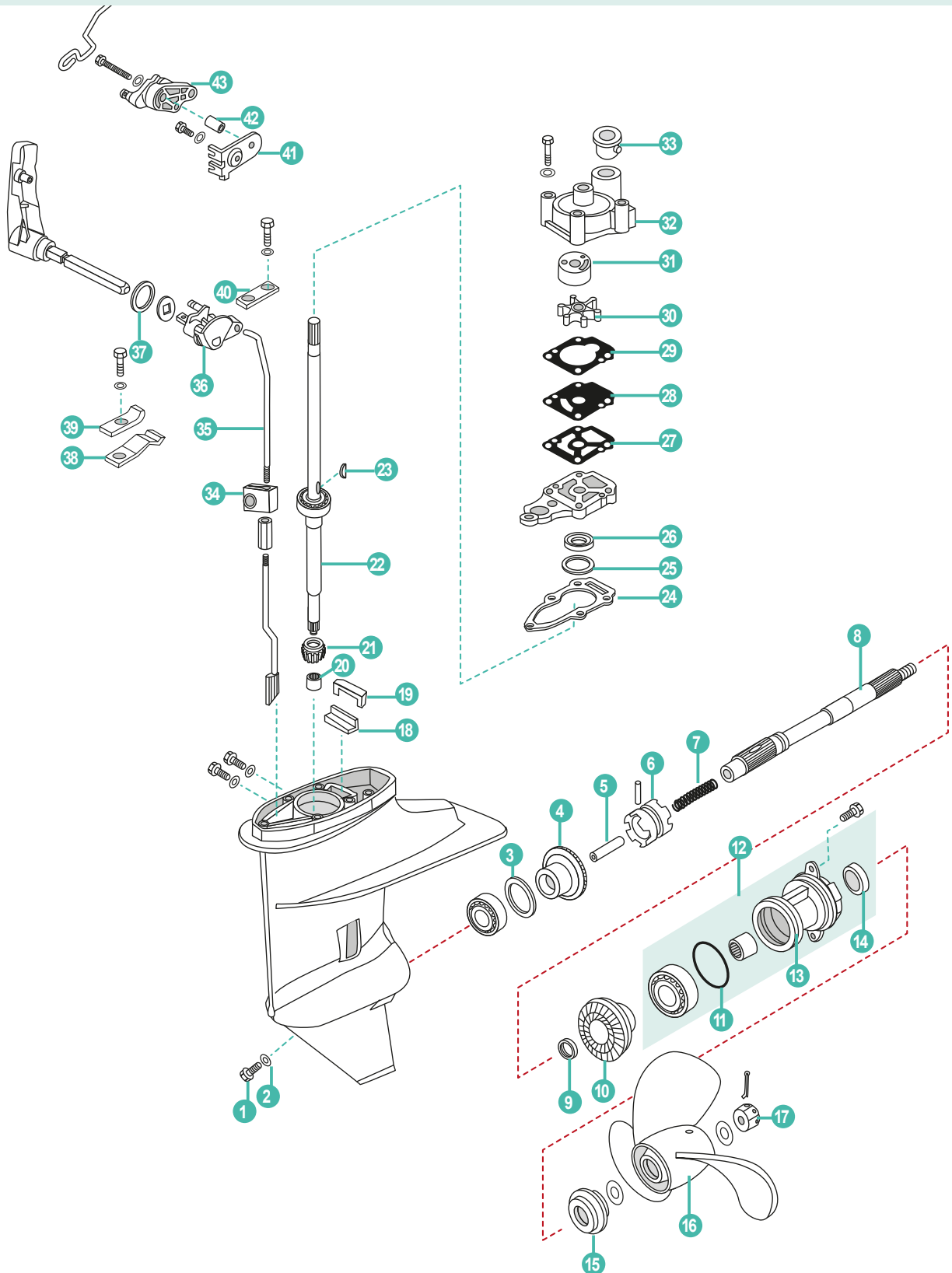

TOHATSU

RECAMBIOS  
MARINOS

|    | REF             | OEM         |                    |                             |                         |   |
|----|-----------------|-------------|--------------------|-----------------------------|-------------------------|---|
| 1  | REC90340-08002  | 332-60005-2 | TAPÓN DRENAJE      | PLUG, OIL HOSE              | CONNETTORE              | BOUCHON DE VIDANGE                      |
| 2  | REC90430-08020  | 332-60006-0 | JUNTA              | GASKET                      | GUARNIZIONE             | JOINT                                   |
| 3  | PAF8-04000012-1 | 369-64014-0 | GRUESO 0.10mm      | SHIM 0.10mm                 | SPESSORE 0.10mm         | CALE 0.10 mm                            |
|    | PAF8-04000012-2 | 369-64015-0 | GRUESO 0.15mm      | SHIM 0.15mm                 | SPESSORE 0.15mm         | CALE 0.15mm                             |
| 4  | PAF8-04010000   | 3B2-64010-0 | PIÑÓN ADELANTE     | GEARM FORWARD               | PIGNONE AVANTI          | PIGNON DE MARCHE AVANT                  |
| 5  | PAF8-04000305   | 369-64223-0 | PIN                | PIN CLUTCH                  | SPINOTTO                | PIN                                     |
| 6  | PAF8-04000303   | 3B2-64215-0 | SELECTOR           | CLUTCH, DOG                 | SELETTORE               | CRABOT                                  |
| 7  | PAF8-04000302   | 3V1-64221-0 | MUELLE             | SPRING, CLUTCH              | MOLLA                   | RESSORT                                 |
| 8  | PAF8-04000301   | 3V1-64211-0 | EJE HÉLICE         | SHAFT, PROPELLER            | ASSE ELICHE             | ARBRE D'HELICE                          |
| 9  | PAF8-04000012   | 369-64032-0 | ARANDELA           | WASHER                      | RONDELLA                | RONDELLE                                |
| 10 | PAF8-04000014   | 3B2-64030-0 | PIÑÓN ATRÁS        | GEAR REVERSE                | PIGNONE MARCIA INDIETRO | PIGNON DE MARCHE ARRIÈRE                |
| 11 | PAF8-04040002   | 345-65015-0 | TÓRICA             | O-RING                      | ANELLO                  | JOINT TORIQUE                           |
| 12 | PAF8-04040000   | 3B2S60100-0 | DIÁBOLO            | COVER ASSY                  | DIABOLO                 | DIABOLO COMPLET                         |
| 13 | PAF8-04040001   | 3B2S60101-0 | DIÁBOLO            | COVER, LOWE CASING          | DIABOLO                 | DIABOLO                                 |
| 14 | PAF8-04040004   | 369-60111-0 | RETÉN              | OIL SEAL                    | PARAOLIO                | JOINT SPI                               |
| 15 | PAF8-04000019   | 3B2-64230-1 | GRUESO             | CUSHION, PROPELLER          | SPESSORE                | CALE                                    |
| 16 | PAF8-04050000   | 3B2W64517-0 | HÉLICE             | PROPELLER ASSY              | ELICHE                  | HELICE                                  |
| 17 | PAF15-06000016  | 369-64121-0 | TUERCA             | NUT, HEXAGON                | DADO                    | ÉCROU                                   |
| 18 | PAF8-04000015   | 3V1-60042-0 | GUÍA SELLO DE GOMA | GUIDE RUBBER SEAL           | GUIDA PARAOLIO          | GUIDE EN CAOUTCHOUC                     |
| 19 | PAF8-04000016   | 3V1-60041-0 | SELLO DE GOMA      | WATER ENVELOP               | PARAOLIO                | SUPPORT EN CAOUTCHOUC                   |
| 20 | PANSKFJ-1516    | 3V1-60211-0 | RODAMIENTO         | BEARING                     | CUSCINETTO              | ROULEMENT                               |
| 21 | PAF8-04000003   | 3B2-64020-0 | PIÑÓN DE ATAQUE    | INITIATIVE GEAR             | PIGNONE ATTACCO         | PIGNON D'ATTAQUE                        |
| 22 | PAF8-04020001L  | 3V1-64307-1 | EJE VERTICAL L     | DRIVE SHAFT L               | ASSE VERTICALE L        | ARBRE DE COMMANDE L                     |
|    | PAF8-04020001S  | 3V1-64306-1 | EJE VERTICAL S     | DRIVE SHAFT S               | ASSE VERTICALE S        | ARBRE DE COMMANDE S                     |
| 23 | PAF8-04000021   | 3B2-65022-0 | PIN                | PIN, DOWER                  | SPINOTTO                | PIN                                     |
| 24 | PAF8-04000005   | 3B2-65020-0 | JUNTA              | GASKET, WATER PUMP SEAT     | GUARNIZIONE             | JOINT                                   |
| 25 | PAF8-04000004-1 | 3B2-64023-0 | GRUESO 0.10 mm     | SHIM 0.10mm                 | SPESSORE 0.10 mm        | CALE 0.10 mm                            |
| 26 | PAF8-04000101   | 309-60111-0 | RETÉN              | OIL SEAL                    | PARAOLIO                | JOINT SPI                               |
| 27 | PAF8-04000006   | 3B2-65029-0 | JUNTA              | GASKET, OUTER PLATE         | GUARNIZIONE             | JOINT                                   |
| 28 | PAF8-04000007   | 3B2-65025-0 | PLACA              | OUTER PLATE                 | PIASTRA                 | PLAQUE                                  |
| 29 | PAF8-04000008   | 3B2-65018-0 | JUNTA              | GASKET, OUTER PLATE         | GUARNIZIONE             | JOINT                                   |
| 30 | PAF8-04000200   | 3B2-65021-1 | IMPULSOR           | IMPELLER                    | GIRANTE                 | TURBINE                                 |
| 31 | PAF8-04000010   | 3B2-65011-0 | CASQUILLO          | INNER SHELL, WATER PUMP     | BOCCOLA                 | COUVERCLE, POMPA À EAU                  |
| 32 | PAF8-04000009   | 3B2-65016-0 | BOMBA DE AGUA      | WATER PUMP                  | POMPA D'ACQUA           | POMPA À EAU                             |
| 33 | PAF8-04000013   | 3B2-65016-0 | RETÉN              | SEAL                        | TENUTA                  | JOINT DE TUBE D'EAU                     |
| 34 | PAF8-03000011   | 3V1-66302-0 | SEGURO             | LOCK BLOCK                  | BLOCCAGGIO              | SUPPORT TIGE DE CHANGEMENT DE VITESSE   |
| 35 | PAF8-03000010   | 3V1-66211-0 | EJE DEL CAMBIO     | SHIFT ROD                   | ASSE CAMBIO             | TIGE CHANGEMENT DE VITESSE              |
| 36 | PAF8-03010003   | 3V1-66225-0 | SEGURO DEL EJE     | BLOCK SHIFT ROD             | BLOCCAGGIO ASSE         | TIGE DE BLOCAGE                         |
| 37 | PAF8-03010001   | 3V1-66187-0 | ARANDELA           | WASHER, HANDLE              | RONDELLA                | RONDELLE                                |
| 38 | PAF8-03010005   | 3B2-66113-0 | TOPE               | STOPPER, SHIFT LEVER        | TAPPO                   | LEVIER                                  |
| 39 | PAF8-03010006   | 3C8-66116-0 | PLACA              | PLATE, SHIFTLIVER STOPPER   | PIASTRA                 | CONTRE PLAQUE LEVIER CAHNGEMENT VITESSE |
| 40 | PAF8-03010007   | 3B1-66145-0 | PLACA              | PLATE                       | PIASTRA                 | PLAQUE                                  |
| 41 | PAF8-05000020   | 3V1-63508-0 | PLACA              | PALTE                       | PIASTRA                 | PLAQUE                                  |
| 42 | PAF8-05000018   | 346-67114-0 | CASQUILLO          | PLATE ACCELEROGRAPH ENFOPCE | BOCCOLA                 | PLAQUE SUPPORT LEVIER PRINCIPAL         |
| 43 | PAF8-05000019   | 3V1-63622-0 | POLEA              | MAIN PULLEY                 | PULEGGIA                | POULIE                                  |

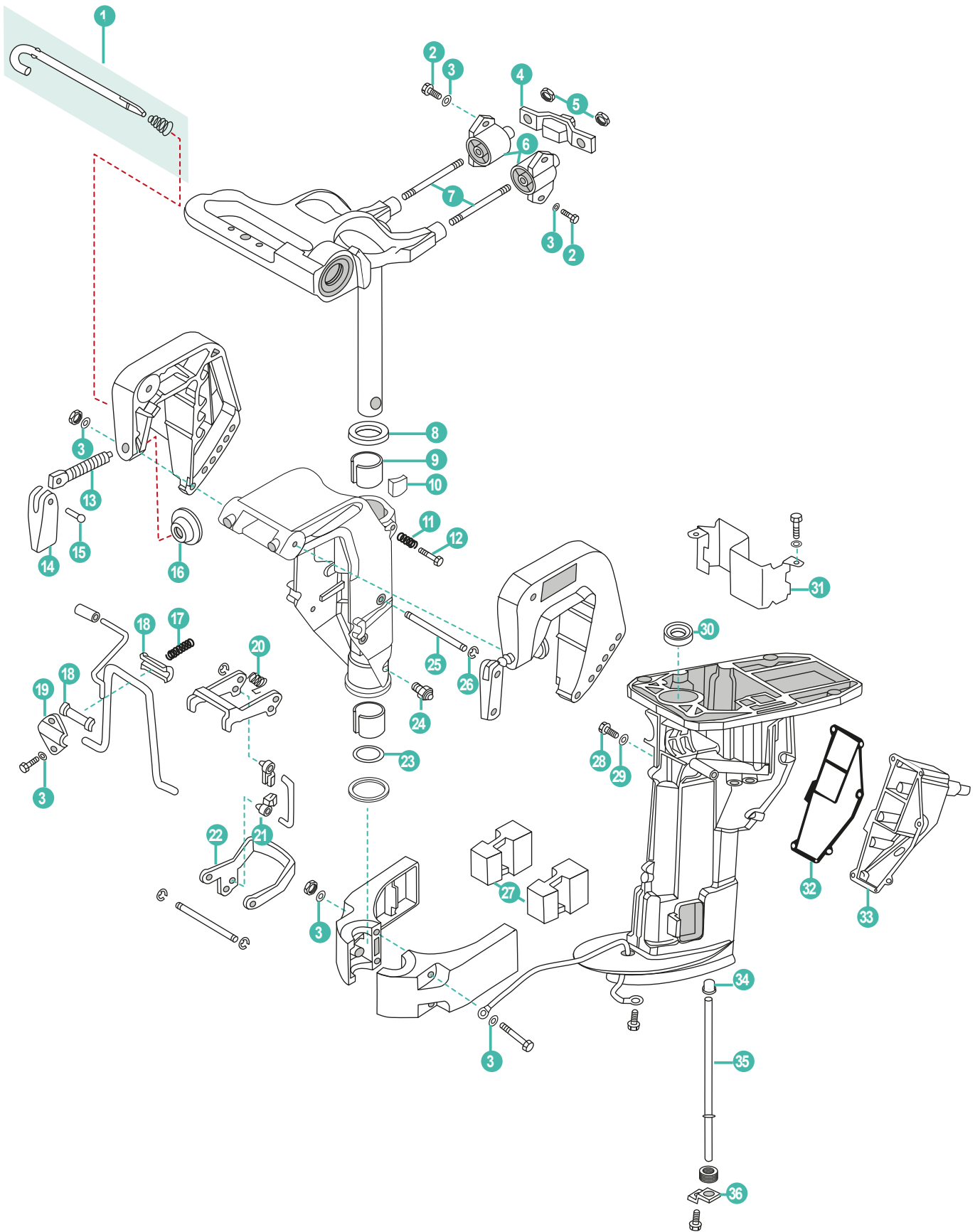

|    | REF              | OEM                        |                      |                             |                               |                                      |
|----|------------------|----------------------------|----------------------|-----------------------------|-------------------------------|--------------------------------------|
| 1  | PAF8-01010200    | 350-62121-1<br>369-62122-2 | GANCHO DE CIERRE     | THRUST ROD ASSY             | ASSE DE CHIUSSURA             | CROCHET DE FERMETURE                 |
| 2  | PAGB/T5783-M6X20 | 910184-5620                | TORNILLO             | BOLT M6x20                  | VITE                          | VIS                                  |
| 3  | PAGB/T97.1-6     | 910184-5620                | ARANDELA             | WASHER                      | RONDELLA                      | RANDELLE                             |
| 4  | PAF8-00000100    | 3V1-61333-1                | SILENBLOCK           | ABSORBER (FRONT)            | SILENBLOCK                    | SILENBLOCK                           |
| 5  | PAGB/T889.1-M8   | 3V1-61324-0                | TUERCA M8            | NUT M8                      | DADO M8                       | ÉCROU M8                             |
| 6  | PAF8-02000100    | 3V1-61301-1<br>940113-0800 | SILENBLOCK           | ABSORBER ASSY               | SILENBLOCK                    | SILENBLOCK                           |
| 7  | PAF8-01000003    | 3V1-61313-0                | TORNILLO M8x65       | DICEPHALOUS BOLT M8x65      | VITE M8x65                    | VIS M8x65                            |
| 8  | PAF8-01000001    | 350-62423-0                | ARANDELA             | WASHER, ROTARY BRACKET      | RONDELLA                      | RONDELLE                             |
| 9  | PAF8-01000002    | 350-62417-0                | CASQUILLO            | BUSHING                     | BOCCOLA                       | ENTRETOISE                           |
| 10 | PAF8-01000100    | 345-62441-0                | SEGURO DE CIERRE     | LOCKING BLOCK ASSY          | CHIUSURA SICUREZA             | BLOC DE VERROUILLAGE                 |
| 11 | PAF8-01010102    | 346-62421-1                | MUELLE               | SPRING, LOCKING             | MOLLA                         | RESSORT                              |
| 12 | PAGB/T5783-M8X30 | 910113-0830                | TORNILLO M8X30       | BOLT M8x30                  | VITE M8X30                    | VIS M8X30                            |
| 13 | PAF4-01010002    | 398-62103-0                | TORNILLO             | CLAMP SCREW                 | VITE                          | VIS                                  |
| 14 | REC6L8-G3118-01  | 332S62102-1                | MANETA               | CLAMP HANDLE, STERN         | MANIGLIA                      | POIGNEE DE BLOCAGE                   |
| 15 | PAF4-01010005    | 3C8-62104-1                | RIBETE               | RIVET, CLAMP HANDLE         | RIVETTO                       | RIVET                                |
| 16 | PAF4-01010003    | 332-62101-0                | ARANDELA             | CLAMP PAD                   | RONDELLA                      | RONDELLE                             |
| 17 | PAF8-01010104    | 369-66112-1                | MUELLE               | SPRING, SUPPORT             | MOLLA                         | RESSORT                              |
| 18 | PAF8-01010103    | 393-62437-0                | PASADOR              | PIN                         | PIN                           | PIN                                  |
| 19 | PAF8-01010105    | 369-62439-1                | PLACA                | PRESS PLATE                 | PIASTRA                       | PLAQUE                               |
| 20 | PAF8-01010109    | 3B2-66315-0                | MUELLE               | SPRING, WREST               | MOLLA                         | RESSORT                              |
| 21 | PAF8-01010112    | 3K9-05223-0                | ADAPTADOR            | TIE-IN, CONNECTING ROD      | ADATTATORE                    | EMBOUT DE CABLE                      |
| 22 | PAF8-01010106    | 3V1-66313-0                | UÑA                  | OUTER FRAME, ROTARY BRACKET | CORNICE ESTERNA               | CADRE EXTERIEUR POUR SUPPORT ROTATIF |
| 23 | PAJASOF40435-022 | 350-62415-0                | RETÉN                | O-RING Ø22.4xØ3.5           | TENUTA ANELLO                 | JOINT                                |
| 24 | PAGB/T7940.1-M6  | 344-67177-0                | ENGRASADOR M6        | OILER M6                    | INGRASSATORE M6               | GRAISSEUR M6                         |
| 25 | PAF8-01010108    | 3B2-66321-1                | EJE                  | SHAFT, ROTARY BRACKET       | ASSE                          | AXE                                  |
| 26 | PAGB/T896-5      | 945303-0500                | CLIP                 | CIRCLIP                     | CLIP                          | CLIP                                 |
| 27 | PAF8-00000002    | 3V1-61302-0                | AMORTIGUADOR         | ABSORBER                    | AMMORTIZZATORE                | SILENT BLOC                          |
| 28 | PAF15-04000002   | 3R3-07405-1                | TAPÓN                | BOLT, OIL DRAIN             | TAPPO                         | BOUCHON                              |
| 29 | PAF15-04000003   | 3R3-07406-0                | JUNTA                | GASKET                      | GUARNIZIONE                   | JOINT                                |
| 30 | PAF8-02000002    | 3B2-01215-0                | RETÉN                | OIL SEAL                    | PARAOILIO                     | JOINT SPI                            |
| 31 | PAF8-02000003    | 3V1-07440-0                | SEPARADOR CARTER     | CLAPBOARD, OIL SUMP         | ASSICELLA, COPPA OLIO         | PLAQUE GUIDE                         |
| 32 | PAF8-02000004    | 3V1-61220-0                | JUNTA TAPA DE ESCAPE | GASKET, EXHAUST OUTER COVER | GUARNIZIONE COPERCHIO SCARICO | JOINT DE COUVERCLE EXT ECHAPPEMENT   |
| 33 | PAF8-02000005    | 3V1-61208-0                | TAPA ESCAPE          | EXHAUST OUTER COVER         | COPERCHIO SCARICO             | COUVERCLE EXT ECHAPPEMENT            |
| 34 | PAF8-02000007    | 3V1-65206-0                | RETÉN TUBO DE AGUA   | UPPER SEAL, WATER PIPE      | TENUTA, TUBO ACQUA            | JOINT SUPERIEUR TUBE D'EAU           |
| 35 | PAF8-02000006(L) | 3V1-65110-0                | TUBO L               | WATER PIPE L                | TUBO L                        | TUYAU D'EAU L                        |
|    | PAF8-02000006(S) | 3V1-65100-0                | TUBO S               | WATER PIPE S                | TUBO S                        | TUYAU D'EAU S                        |
| 36 | PAF8-02000009    | 3V1-65203-0                | PLACA TUBO DE AGUA   | PLATE, WATER PIPE           | PIASTRA, TUBO ACQUA           | PLAQUE PIPE D'EAU                    |



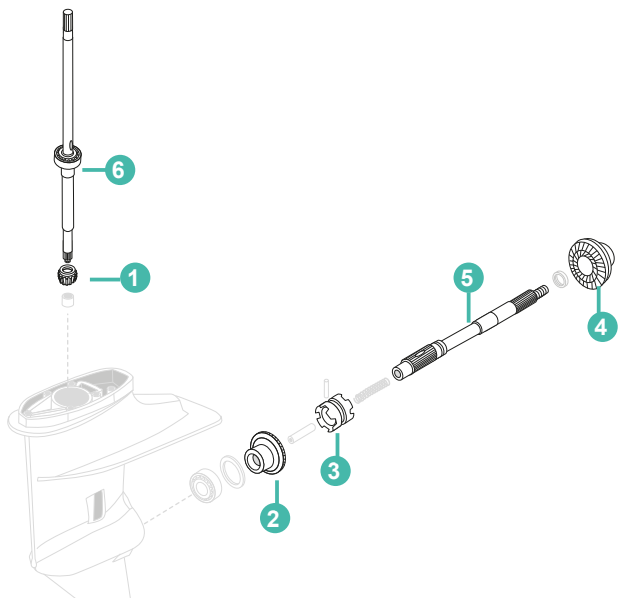

GUÍA PIEZAS COLA

STERN DRIVE  
COMPONENTS GUIDE

GUIDA RICAMBI  
PIEDI

GUIDE PIECES  
D'EMBASE

|  | 1               | 2               | 3             | 4               | 5             | 6<br>S         | 6<br>L         |
|---|-----------------|-----------------|---------------|-----------------|---------------|----------------|----------------|
| M2.5A, B, A2  | REC43-16138     | REC43-812944    |               |                 |               |                |                |
| M3.5A, B, A2, B2  | REC43-16138     | REC43-812944    |               |                 |               |                |                |
| M4C<br>M5B, BS  | REC43-16138     | REC43-812944    |               | REC43-8129451   | REC44-195133  | REC45-161351   | REC8M0076368   |
| MFS4, 5, 6A2, B, C  | REC43-16138     | REC43-812944    |               | REC43-8129451   | REC44-195133  | REC45-161351   | REC8M0076368   |
| MFS8, 9.8B  | PAF8-04000003   | PAF8-04010000   |               | PAF8-04000014   | PAF8-04000301 |                |                |
| MFS8A2-3<br>MFS9.8A2-3<br>M9.9  | PAF8-04000003   | PAF8-04010000   | PAF8-04000303 | PAF8-04000014   | PAF8-04000301 | PAF8-04020001S | PAF8-04020001L |
| M15D2<br>M18E2<br>MFS9.9B2  | REC43-803740    | REC43-803739    |               | REC43-803741    | REC879147T96  | REC45-803738   | REC45-8037381  |
| MFS15B2<br>MFS18B2  | REC43-803740T02 | REC43-803739T03 |               | REC43-803741T03 | REC879147T96  |                |                |

# SISTEMA DE PROPULSIÓN PROPULSION SYSTEM

# SISTEMA DI PROPULSIONE SYSTEME DE PROPULSION

| HÉLICES ALUMINIO E INOXIDABLE DE 3 Y 4 PALAS  | 3 & 4 BLADE ALUMINIUM & SS PROPELLERS   | ELICHE ALLUMINIO E INOX DA 3 E 4 PALE   | HELICE ALUMINIUM ET INOX 3 ET 4 PALES  |
|---|---|---|--|
| CÓDIGO DE REFERENCIAS   | PART NO. CODING SYSTEM  | SISTEMA DI CODICE   | CODAGE DES REFERENCES  |
|   |   |   |  |
| <p>1. Mercury, Mariner<br/>2. Johnson, Evinrude<br/>3. Yamaha<br/>4. Suzuki<br/>5. Tohatsu<br/>6.<br/>7.<br/>8. Volvo Penta<br/>9. Rubex System</p> | <p>0.5, 6, 8 and 9.8 HP Group<br/>1. A Group<br/>2. B Group<br/>3. C Group<br/>4. D Group<br/>5. E Group<br/>6. F Group<br/>7. VP (Std. Hub)<br/>8. VP (Long Hub)</p> | <p>1. AL<br/>2. Saturn (INOX   Stainless Steel)<br/>3. New Saturn (INOX   Stainless Steel)<br/>4. Titan (INOX   Stainless Steel)<br/>5. HR Titan (INOX   Stainless Steel)<br/>6. Scorpion (INOX   Stainless Steel)<br/>7. Lector (INOX   Stainless Steel)</p> | <p>1. 3R Rubber Hub<br/>2. 3L Rubber Hub<br/>3. 4R Rubber Hub<br/>4. 4L Rubber Hub</p> |

SOLAS

## AMITA 3

SOLAS

Hélice de aluminio con núcleo de goma de gran resistencia.

Aluminum propeller with heavy duty rubber hub.

Eliche di alluminio con mozzi in gomma ad alta resistenza.

Hélice en aluminium avec moyeu en caoutchouc



## AMITA 4

SOLAS

Hélices de aluminio con núcleo de goma de gran resistencia. Van muy suaves a poca velocidad y hace el barco muy manejable con la mar picada.

Aluminum propeller with heavy duty rubber hub. Smoother low speed makes the offshore boating activity much easier.

Eliche di alluminio con mozzo in gomma ad alta resistenza. Molto morbido a bassa velocità e rende la barca molto maneggevole con mare cattivo.

Hélice en aluminium avec moyeu en caoutchouc. Permet d'aller doucement à basse vitesse et rende le bateau très maniable lorsque la mer est agitée



## NEW SATURN

SOLAS

Hélices de acero inoxidable. Ofrece buena aceleración y rendimiento. Tamaño más pequeño que ofrece un diámetro extragrande.

Stainless steel propeller. Offers good acceleration & all-round performance. Smaller pitch sizes offered in extra large diameter with increased blade area.

Eliche di acciaio inox. Buona accelerazione. Piccole dimensioni che offre un più grande diametro.

Hélice inox, offrant de bonnes accélérations et performances. Taille de pas réduite pour les modèles de grands diamètres avec une surface de pale plus importante.

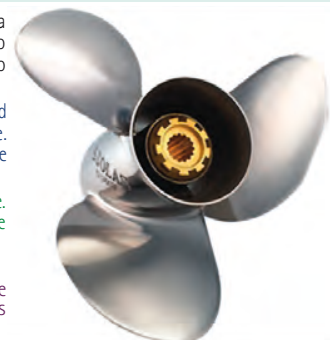

**GUÍA DE HÉLICES  
CON NÚCLEO INTEGRADO**

**PROPELLERS APPLICATION  
WITH RUBBER HUB**

**GUIDA ELICHE  
CON MOZZO**

**GUIDE DES HÉLICES  
ET MOYEUX**

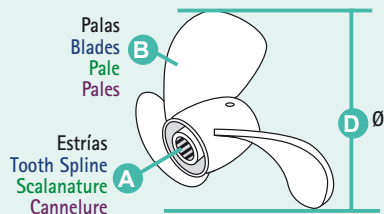

|                              | 2T<br>STROKES | 4T<br>STROKES | R.O.<br>OEM | A B D P R |   |       |  |      | AL      |                | INOX<br>STAINLESS STEEL |                |
|------------------------------|---------------|---------------|-------------|-----------|---|-------|--|------|---------|----------------|-------------------------|----------------|
|                              |               |               |             |           |   |       |  |      | AMITA 3 | AMITA 4        |                         | NEW SATURN     |
| 5                            | ✓             |               |             |           |   |       |  | 7    | R       | SOL5011-078-07 |                         |                |
| 4, 5, 6                      |               | ✓             |             | 3         |   | 7,8   |  | 8    |         | SOL5011-078-08 |                         |                |
|                              |               |               | 3B2-64513-0 |           |   |       |  | 6,5  |         | SOL5011-085-07 |                         |                |
| 8, 9'8                       | ✓             | ✓             | 3B2-64515-0 | 12        | 3 | 8,5   |  | 7,5  | R       | SOL5011-085-08 |                         |                |
|                              |               |               | 3B2-64517-0 |           |   |       |  | 8,5  |         | SOL5011-085-09 |                         |                |
|                              |               |               | 362-64105-0 |           |   |       |  | 6,9  |         | SOL5111-093-07 |                         |                |
| 9'9, 12, 15, 18              | ✓             |               | 362-64103-0 |           |   |       |  | 7,8  |         | SOL5111-093-08 |                         |                |
|                              |               |               | 362-64101-0 |           |   |       |  | 8,8  |         | SOL5111-093-09 |                         |                |
|                              |               |               |             | 14        | 3 | 9,2   |  | 9,1  | R       | SOL5111-093-09 |                         |                |
| 9'9, 15, 18, 20              |               | ✓             | 362-64108-0 |           |   |       |  | 9,8  |         | SOL5111-093-10 |                         |                |
|                              |               |               |             |           |   |       |  | 11   |         | SOL5111-093-11 |                         |                |
|                              |               |               | 346-64101-5 |           |   | 9,8   |  | 9,3  |         | SOL5211-099-09 |                         |                |
|                              |               |               | 346-64102-5 |           |   | 9,8   |  | 10,2 |         | SOL5211-099-10 |                         |                |
| 25, 30                       | ✓             | ✓             | 346-64103-5 |           |   | 9,8   |  | 11,3 | R       | SOL5211-099-11 |                         |                |
|                              |               |               |             |           |   | 9,9   |  | 12   |         | SOL5211-099-12 |                         |                |
|                              |               |               | 346-64104-5 |           |   | 9,8   |  | 13,1 |         | SOL5211-099-13 |                         |                |
|                              |               |               |             |           |   | 12,2  |  | 7    |         | SOL5311-122-07 |                         |                |
|                              |               |               | 361-64113-0 |           |   | 12,2  |  | 8    |         | SOL5311-122-08 |                         |                |
|                              |               |               | 361-64114-0 |           |   | 12,1  |  | 9    |         | SOL5311-121-09 | SOL5313-118-09          |                |
|                              |               |               | 348-64102-0 |           |   | 11,6  |  | 11   |         | SOL5311-116-11 | SOL5313-111-11          |                |
| 35, 40, 50, 55               | ✓             |               | 348-64103-0 |           |   | 11,4  |  | 12   |         | SOL5311-114-12 | SOL5313-108-12          |                |
|                              |               |               | 3E3-64528-0 | 13        | 3 | 11,1  |  | 13   | R       | SOL5311-111-13 | SOL5313-105-13          |                |
|                              |               |               | 3E3-64536-0 |           |   | 11,1  |  | 14   |         | SOL5311-111-14 | SOL5313-105-14          |                |
|                              |               |               |             |           |   | 11    |  | 15   |         | SOL5311-110-15 |                         |                |
|                              |               |               |             |           |   | 11    |  | 16   |         | SOL5311-110-16 |                         |                |
|                              |               |               |             |           |   | 11    |  | 17   |         | SOL5311-110-17 |                         |                |
|                              |               |               | 3B7-64523-1 |           |   | 14    |  | 11   |         | SOL3411-140-11 |                         |                |
|                              |               |               | 3B7-64527-1 |           |   | 13,75 |  | 13   |         | SOL3411-138-13 | SOL3413-133-13          |                |
| 60, 70, 90, 115,<br>120, 140 | ✓             |               | 3C7-64536-0 |           |   | 13,5  |  | 15   |         | SOL3411-135-15 | SOL3413-130-15          | SOL3431-135-15 |
|                              |               |               | 3C7-64541-0 | 15        | 3 | 13,25 |  | 17   | R       | SOL3411-133-17 | SOL3413-128-17          | SOL3431-133-17 |
|                              |               |               | 3C7-64554-0 |           |   | 13    |  | 19   |         | SOL3411-130-19 | SOL3413-125-19          | SOL3431-130-19 |
|                              |               |               |             |           |   | 13    |  | 21   |         | SOL3411-130-21 | SOL3413-125-21          | SOL3431-130-21 |



- P** Paso  
Pitch  
Passo  
Pas
- R** Rotación L (izquierda) R (derecha)  
Rotation L (left) R (Right)  
Rotazione L (SX) R (DX)  
Rotation L (gauche) R (droit)

**NÚCLEO INTERCAMBIABLE INTERCHANGEABLE HUB**

**MOZZO INTERCAMBIABILE MOYEU INTERCHANGEABLE**

|                       | A  | REF        |  |
|--|----|------------|---|
| 35HP (35B only) (1984+)<br>40HP (1984+),<br>50HP (All except 50C) (1992+)<br>50HP (50C only) (1987-91) | 13 | SOLRBX-116 | C   |
| 55HP (1981-88)<br>60A (1986+)<br>70A/70B (1981+)   | 13 | SOLRBX-112 | C   |
| 90-140HP, (1987+)  | 13 | SOLRBX-109 | D   |



**RUBEX**

**HÉLICES PARA NÚCLEO INTERCAMBIABLE**

**PROPELLERS FOR INTERCHANGEABLE HUB**

**ELICHE PER MOZZO INTERCAMBIABILE**

**HELICES AVEC MOYEU INTERCHANGEABLE**

|  | B | D     | P  | R | AL             |
|---|---|-------|----|---|----------------|
| <b>C</b><br>30-75 HP  | 3 | 11.4  | 12 | R | SOL9311-114-12 |
|   |   | 11.1  | 13 | R | SOL9311-111-13 |
|   |   | 14    | 9  | R | SOL9411-140-09 |
|   |   | 14    | 11 | R | SOL9411-140-11 |
| <b>D</b><br>40-140 HP   | 3 | 13.75 | 13 | R | SOL9411-138-13 |
|   |   | 13.50 | 15 | R | SOL9411-135-15 |
|   |   | 13.25 | 17 | R | SOL9411-133-17 |
|   |   | 13.2  | 19 | R | SOL9411-132-19 |
|   |   | 13.2  | 21 | R | SOL9411-132-21 |
|   |   | 15.5  | 11 | R | SOL9511-155-11 |
| <b>E</b><br>135-350 HP  | 3 | 15.3  | 13 | R | SOL9511-153-13 |
|   |   | 16    | 13 | R | SOL9511-160-13 |
|   |   | 15    | 15 | R | SOL9511-150-15 |
|   |   | 15    | 15 | L | SOL9512-150-15 |
|   |   | 14.8  | 17 | R | SOL9511-148-17 |
|   |   | 14.8  | 17 | L | SOL9512-148-17 |
|   |   | 14.5  | 19 | R | SOL9511-145-19 |
|   |   | 14.5  | 19 | L | SOL9512-145-19 |
|   |   | 14.3  | 21 | R | SOL9511-143-21 |
|   |   | 14.3  | 21 | L | SOL9512-143-21 |

|  | B | D                 | P  | R | INOX STAINLESS STEEL |
|---|---|-------------------|----|---|----------------------|
| <b>D</b><br>40-140 HP   | 3 | 13 <sup>3/4</sup> | 13 | R | SOL9431-138-13       |
|   |   | 13 <sup>3/4</sup> | 13 | L | SOL9432-138-13       |
|   |   | 13 <sup>1/2</sup> | 15 | R | SOL9431-135-15       |
|   |   | 13 <sup>1/2</sup> | 15 | L | SOL9432-135-15       |
|   |   | 13 <sup>1/4</sup> | 17 | R | SOL9431-133-17       |
|   |   | 13 <sup>1/4</sup> | 17 | L | SOL9432-133-17       |
|   |   | 13                | 19 | R | SOL9431-130-19       |
|   |   | 13                | 19 | L | SOL9432-130-19       |
|   |   | 13                | 21 | R | SOL9431-130-21       |
|   |   | 13                | 21 | L | SOL9432-130-21       |
| <b>E</b><br>90-140 HP   | 3 | 14 <sup>1/2</sup> | 15 | R | SOL9531-145-15       |
|   |   | 14 <sup>1/2</sup> | 15 | L | SOL9532-145-15       |
|   |   | 14 <sup>1/4</sup> | 17 | R | SOL9531-143-17       |
|   |   | 14 <sup>1/4</sup> | 17 | L | SOL9532-143-17       |
|   |   | 14                | 19 | R | SOL9531-140-19       |
|   |   | 14                | 19 | L | SOL9532-140-19       |
|   |   | 14                | 21 | R | SOL9531-140-21       |
|   |   | 14                | 21 | L | SOL9532-140-21       |
|   |   | 14                | 23 | R | SOL9531-140-23       |
|   |   | 14                | 23 | L | SOL9532-140-23       |
| <b>E</b><br>135-350 HP  | 3 | 15 <sup>3/4</sup> | 15 | R | SOL9571-158-15       |
|   |   | 15 <sup>3/4</sup> | 15 | L | SOL9572-158-15       |
|   |   | 15 <sup>1/2</sup> | 17 | R | SOL9571-155-17       |
|   |   | 15 <sup>1/2</sup> | 17 | L | SOL9572-155-17       |
|   |   | 15 <sup>1/4</sup> | 19 | R | SOL9571-153-19       |
|   |   | 15 <sup>1/4</sup> | 19 | L | SOL9572-153-19       |
|   |   | 15                | 21 | R | SOL9571-150-21       |
|   |   | 15                | 21 | L | SOL9572-150-21       |
|   |   | 14 <sup>3/4</sup> | 23 | R | SOL9571-148-23       |
|   |   | 14 <sup>3/4</sup> | 23 | L | SOL9572-148-23       |

**RUBEX**



Núcleo intercambiable (no incluido).  
Interchangeable hub (not included).  
Mozzo intercambiabile (non incluso).  
Moyeu interchangeable (non inclus)

# REF--> RO / OEM

| REF              | R.O. / OEM     |         |
|------------------|----------------|---------|
| <b>C</b>         |                |         |
| CEF500337        | HZW1-19210-B04 | 604     |
| CEF500338        | HZV5-19210-003 | 604     |
| CEF500344        | 3B2-65021-1    | 589-604 |
| CEF500377        | 369-65021-1    | 589-604 |
| CEF500379        | 345-65021-1    | 604     |
| CEF500382        | 345-65021-0    | 589-604 |
| CEF500383        | 334-65021-0    | 589-604 |
| CEF500388        | 3B7-65021-2    | 604     |
| CEF500388        | 3C7-65021-1    | 604     |
| CEF500391        | HZY3-19210-003 | 604     |
| CEF500396        | 309-65021-1    | 604     |
| CM33860-2181     | 338-60218-2    | 606     |
| CM348-60217-0M   | 348-60217-0    | 606     |
| CM3B7-602170     | 3B7-60217-0    | 606     |
| CM3B7-60218-0    | 3B7-60218-1    | 606     |
| CM3C760-2181     | 3C7760-2181    | 606     |
| CM3C760-2181A    | 3C7760-2181    | 606     |
| CM3C8-60217-0    | 3C8-60217-1    | 606     |
| CM3H6-60218-000  | 3H6-60218-0    | 606     |
| CM3H6-60218-000A | 3H6-60218-0    | 606     |
| CM3M2-60218-1    | 3M2-60218-0    | 606     |
| CM3V1-60217-0    | 3V1602170      | 606     |
| CM3V1-60217-0A   | 3V1602170      | 606     |
| CM5338602182A0   | 5338602182A0   | 606     |
| CM5338602182A0A  | 5338602182A0   | 606     |
| CHAL78C          |                | 600     |
| CHAL82C          |                | 600     |
| CHAL82YC         |                | 600     |
| CHAL86C          |                | 600     |
| CHAL87YCC        |                | 600     |
| CHARA8HC         |                | 600     |
| <b>G</b>         |                |         |
| GS30435          |                | 595     |
| GS31001          |                | 594     |
| GS31002          |                | 594     |
| GS31015          | 394-702500M    | 592     |
| GS31016          | 3B2-702801M    | 592     |
| GS31017          |                | 592     |
| GS31018          | 3B2-702601M    | 592     |
| GS31019          | 99998-0MA2     | 591     |
| GS31020          |                | 591     |
| GS31064          |                | 592     |
| GS31065          |                | 594     |
| GS31066          |                | 594     |
| GS31067          |                | 594     |
| GS31068          |                | 591     |
| GS31069          |                | 591     |
| GS31073          |                | 591     |
| GS31088          |                | 591     |
| GS31090          |                | 590     |
| GS31090          |                | 590     |
| GS31095          |                | 590     |
| GS31096          |                | 590     |
| GS31097          |                | 590     |
| GS31099          |                | 590     |
| GS31155          |                | 594     |
| GS31156          |                | 594     |
| GS31157          |                | 594     |
| GS31166          |                | 594     |
| GS31183          |                | 590     |
| GS31187          | 65770-95541    | 590     |
| GS31189          |                | 590     |
| GS35031          |                | 590     |
| GS35032          |                | 590     |
| GS31183          |                | 442     |
| GS31187          |                | 442     |
| GS31189          |                | 442     |
| GS35031          |                | 442     |
| GS35032          |                | 442     |
| <b>L</b>         |                |         |
| LENS3213         |                | 593     |
| LENS3227         | 99105-20005    | 593     |
| <b>N</b>         |                |         |
| NGKB7HS-10       | 9701-1-1005    | 600     |
| NGKB8HS-10       | 9701-1-1006    | 600     |
| NGKBP7HS-10      | 9701-1-1010    | 600     |
| NGKBP7HS-10      | 9701-1-1013    | 600     |
| NGKBP7HS-10      | 9701-1-1014    | 600     |
| NGKBR7HS-10      | 9701-1-1015    | 600     |
| NGKBR8HS-10      | 9701-1-1110    | 600     |
| NGKDCPR6E        | 9701-1-1103    | 589-600 |
| NGKIKR6G8        | 9701-1-1121    | 600     |
| NGKIZFR5J        | 9791-1-1109    | 600     |
| NGKIZFR6         | 9701-1-1111    | 600     |
| NGKLMAR6C-9      | HZZ3-31909-003 | 600     |

| REF              | R.O. / OEM     |         |
|------------------|----------------|---------|
| <b>P</b>         |                |         |
| PAF15-04000002   | 3R3-07405-1    | 625     |
| PAF15-04000003   | 3R3-07406-0    | 625     |
| PAF15-06000016   | 369-64121-0    | 623     |
| PAF15-07000017   | 3V1-02011-0    | 615     |
| PAF15-07000018   | 3V1-03952-0    | 615     |
| PAF15-07000031   | HZW9-19300-003 | 603     |
| PAF15-07010100   | 3H6-07611-0    | 598-613 |
| PAF15-07010101   | 3H6-07612-0    | 613     |
| PAF15-07020005   | 350-00024-1    | 615-620 |
| PAF15-07040303   | 3R0-07238-0    | 615     |
| PAF15-07040304   | 3H8-07237-0    | 615     |
| PAF15-07080000   | 3AC-02230-0    | 594     |
| PAF15-07080000   | 3AD-02230-0    | 594     |
| PAF15-07080000   | 3B7-02230-0    | 594     |
| PAF4-01010002    | 398-62103-0    | 625     |
| PAF4-01010003    | 332-62101-0    | 625     |
| PAF4-01010005    | 3C8-62104-1    | 625     |
| PAF4-04000019    | 3T5-10131-0    | 615     |
| PAF4-04000030    |                | 591     |
| PAF4-04130101    | 3AA-05019-0    | 616     |
| PAF4-04130102    | 3R1-05131-0    | 616     |
| PAF4-05000010    |                | 591     |
| PAF4-05000300    | 369-02230-0    | 595     |
| PAF4-05000300    | 396-02230-0    | 595     |
| PAF4-05000300    |                | 589     |
| PAF40-0701000E1  |                | 594     |
| PAF8-00000002    | 3V1-61302-0    | 625     |
| PAF8-00000003    | 3R3-61017-0    | 615     |
| PAF8-00000004    | 3V1-01303-0    | 615     |
| PAF8-00000100    | 3V1-61333-1    | 625     |
| PAF8-00000200    | 3V1-07421-0    | 615     |
| PAF8-005030010   | 3H8-07226-0    | 615     |
| PAF8-01000001    | 350-62423-0    | 625     |
| PAF8-01000002    | 350-62417-0    | 625     |
| PAF8-01000003    | 3V1-61313-0    | 625     |
| PAF8-01000100    | 345-62441-0    | 625     |
| PAF8-01010102    | 346-62421-1    | 625     |
| PAF8-01010103    | 393-62437-0    | 625     |
| PAF8-01010104    | 369-66112-1    | 625     |
| PAF8-01010105    | 369-62439-1    | 625     |
| PAF8-01010106    | 3V1-66313-0    | 625     |
| PAF8-01010108    | 3B2-66321-1    | 625     |
| PAF8-01010109    | 3B2-66315-0    | 625     |
| PAF8-01010112    | 3K9-05223-0    | 625     |
| PAF8-01010200    | 350-62121-1    | 625     |
| PAF8-01010200    | 369-62122-2    | 625     |
| PAF8-02000002    | 3B2-01215-0    | 625     |
| PAF8-02000003    | 3V1-07440-0    | 625     |
| PAF8-02000004    | 3V1-61220-0    | 625     |
| PAF8-02000005    | 3V1-61208-0    | 625     |
| PAF8-02000006(L) | 3V1-65110-0    | 625     |
| PAF8-02000006(S) | 3V1-65100-0    | 625     |
| PAF8-02000007    | 3V1-65206-0    | 625     |
| PAF8-02000009    | 3V1-65203-0    | 625     |
| PAF8-02000100    | 3V1-61301-1    | 625     |
| PAF8-02000100    | 940113-0800    | 625     |
| PAF8-03000010    | 3V1-66211-0    | 623     |
| PAF8-03000011    | 3V1-66302-0    | 623     |
| PAF8-03010001    | 3V1-66187-0    | 623     |
| PAF8-03010003    | 3V1-66225-0    | 623     |
| PAF8-03010005    | 3B2-66113-0    | 623     |
| PAF8-03010006    | 3C8-66116-0    | 623     |
| PAF8-03010007    | 3B1-66145-0    | 623     |
| PAF8-04000003    | 3B2-64020-0    | 623-626 |
| PAF8-04000004-1  | 3B2-64023-0    | 623     |
| PAF8-04000005    | 3B2-65020-0    | 623     |
| PAF8-04000006    | 3B2-65029-0    | 623     |
| PAF8-04000007    | 3B2-65025-0    | 605-623 |
| PAF8-04000008    | 3B2-65018-0    | 623     |
| PAF8-04000009    | 3B2-65016-0    | 623     |
| PAF8-04000010    | 3B2-65011-0    | 605-623 |
| PAF8-04000012    | 369-64032-0    | 623     |
| PAF8-04000012-1  | 369-64014-0    | 623     |
| PAF8-04000012-2  | 369-64015-0    | 623     |
| PAF8-04000013    | 3B2-65016-0    | 623     |
| PAF8-04000014    | 3B2-64030-0    | 623-626 |
| PAF8-04000015    | 3V1-60042-0    | 623     |
| PAF8-04000016    | 3V1-60041-0    | 623     |
| PAF8-04000019    | 3B2-64230-1    | 623     |
| PAF8-04000021    | 3B2-65022-0    | 623     |
| PAF8-04000101    | 309-60111-0    | 623     |
| PAF8-04000200    | 3B2-65021-1    | 623     |
| PAF8-04000301    | 3V1-64211-0    | 623-626 |
| PAF8-04000302    | 3V1-64221-0    | 623     |
| PAF8-04000303    | 3B2-64215-0    | 623-626 |
| PAF8-04000305    | 369-64223-0    | 623     |
| PAF8-04010000    | 3B2-64010-0    | 623-626 |
| PAF8-04020001L   | 3V1-64307-1    | 623-626 |
| PAF8-04020001S   | 3V1-64306-1    | 623-626 |
| PAF8-04040000    | 3B2S60100-0    | 623     |
| PAF8-04040001    | 3B2S60101-0    | 623     |

| REF              | R.O. / OEM     |         |
|------------------|----------------|---------|
| PAF8-04040002    | 345-65015-0    | 623     |
| PAF8-04040004    | 369-60111-0    | 623     |
| PAF8-04050000    | 3B2W64517-0    | 623     |
| PAF8-05000002    | 3V1-01024-0    | 615     |
| PAF8-05000003    | 172-36008-0    | 616     |
| PAF8-05000004    | 3V1-10045-0    | 589-615 |
| PAF8-05000006    | 3A0-76079-0    | 613     |
| PAF8-05000007    | 3B7-06305-0    | 613     |
| PAF8-05000008    | 3V1-02010-1    | 615     |
| PAF8-05000009    | 3V1-02104-0    | 615     |
| PAF8-05000011    | 3T5-06920-0    | 613     |
| PAF8-05000012    | 3V1-06308-0    | 616     |
| PAF8-05000013    | 3V1-06302-0    | 616     |
| PAF8-05000017    | 98AH10-0120    | 615     |
| PAF8-05000018    | 346-67114-0    | 623     |
| PAF8-05000019    | 3V1-63622-0    | 623     |
| PAF8-05000020    | 3V1-63508-0    | 623     |
| PAF8-05000021    | 3R0-66308-0    | 613     |
| PAF8-05000024    | 369-00132-0    | 613     |
| PAF8-05000024    | 98AB-5-0330    | 615     |
| PAF8-05000025    | 369-84398-0    | 615     |
| PAF8-05000100    | 3V1-02305-0    | 615     |
| PAF8-05000200    | 3V1-06071-0    | 599-613 |
| PAF8-05000300    | 3AA-06021-0    | 598-613 |
| PAF8-05000400    | 3AA-06060-0    | 613     |
| PAF8-05000400    | 3AA-06060-00   | 601     |
| PAF8-05000400    | 3AA060600M     | 601     |
| PAF8-05000500    | 3V1-06040-0    | 599-613 |
| PAF8-05000500    | 3V1060400      | 599     |
| PAF8-05000500    | 3V1060400M     | 599     |
| PAF8-05000600    | 3AA-06091-0    | 613     |
| PAF8-05000800    | 3V1-07410-0    | 615     |
| PAF8-05010000    | 3V1B01100-0    | 615     |
| PAF8-05010002    | 3H8-02093-0    | 615     |
| PAF8-05010004    | 3V1-02305-0    | 615     |
| PAF8-05010005    | 346-01032-0    | 615     |
| PAF8-05010009    | 3V1-07407-0    | 615     |
| PAF8-05010012    | 3V1-00121-0    | 615     |
| PAF8-05010014    | 3V1-10060-0    | 615     |
| PAF8-05010015    | 3V1-10063-0    | 615     |
| PAF8-05010016    | 3V1-10068-0    | 615     |
| PAF8-05020001    | 3V1-00030-1    | 615     |
| PAF8-05020101    | 3V1-00001-0    | 615-620 |
| PAF8-05020105    | 332-00021-0    | 615     |
| PAF8-05020105    | 332-00024-0    | 620     |
| PAF8-05020200    | 3V1-00040-0    | 615-620 |
| PAF8-05030001    | 3V1-07201-0    | 615     |
| PAF8-05030002    | 3V1-07202-0    | 615     |
| PAF8-05030004    | 3V1-07205-0    | 615     |
| PAF8-05030005    | 3AA-07203-0    | 615     |
| PAF8-05030006    | 3V1-07221-0    | 615     |
| PAF8-05030007    | 3H6-07223-0    | 615     |
| PAF8-05030008    | 3V1-07010-0    | 615     |
| PAF8-05030009    | 3AA-07225-0    | 615     |
| PAF8-05030011    | 3H8-07025-0    | 615     |
| PAF8-05030012    | 3V1-07653-0    | 615     |
| PAF8-05030015    | 3R3-07227-0    | 615     |
| PAF8-05030100    | 3V1B01001-0    | 615     |
| PAF8-05030200    | 3V1-07235-0    | 615     |
| PAF8-05030300    | 3V1-07600-0    | 615     |
| PAF8-05030400    | 3H8-10062-2    | 615     |
| PAF8-05040000    | 3V2-03100-2    | 596     |
| PAF8-05050002    | 3V1-05259-0    | 616     |
| PAF8-05050003    | 3R1-05125-0    | 616     |
| PAF8-05050004    | 3AA-05004-0    | 616     |
| PAF8-05050005    | 3V1-05104-1    | 616     |
| PAF8-05050006    | 3R1-05003-1    | 616     |
| PAF8-05050007    | 3R1-05012-0    | 616     |
| PAF8-05050009    | 3R1-05007-0    | 616     |
| PAF8-05050018    | 3AA-05013-0    | 616     |
| PAF8-05090000W   | 3V1-06023-0    | 599     |
| PAGB/T5783-M6X30 | 910184-5620    | 625     |
| PAGB/T5783-M8X30 | 910113-0830    | 625     |
| PAGB/T940.1-M6   | 344-67177-0    | 625     |
| PAGB/T889.1-M8   | 3V1-61324-0    | 625     |
| PAGB/T896-5      | 945303-0500    | 625     |
| PAGB/T97.1-6     | 910184-5620    | 625     |
| PAJASOF40435-022 | 350-62415-0    | 625     |
| PANSKFJ-1516     | 3V1-60211-0    | 623     |
| PAT15-04000011   | 940121-1200    | 613     |
| PAT3.6-04000006  | 309-00131-0    | 615     |
| PH130-0006       | 3C8-76010-1    | 600     |
| PH130-0006       | 3C8760101      | 600     |
| PH130-0006       | 3C8760101M     | 600     |
| PH130-0048       | 353-76010-4    | 600     |
| PH130-0061       | 350-76010-0    | 600     |
| PH130-0061       | 3AA760100      | 600     |
| PH130-0070       | HZY3-31200-003 | 601     |
| PH130-0080       | 346-76010-0M   | 600     |
| PH200-T024       |                | 602     |
| PH200-WH01       |                | 602     |

TOHATSU

RECAMBIOS MARINOS



| REF                       | R.O. / OEM      |             |
|---------------------------|-----------------|-------------|
| <b>RAC23289-10</b>        |                 | 593         |
| <b>RAC23299-10</b>        |                 | 593         |
| <b>RAC320R-RAC-01</b>     |                 | 593         |
| <b>RAC320R-RAC-03</b>     |                 | 593         |
| <b>RAC490R-RAC-01</b>     | 99105-20005-ASY | 593         |
| <b>RACPF5510</b>          |                 | 592         |
| <b>RACRK22628</b>         |                 | 594         |
| <b>RACS3213</b>           |                 | 593         |
| <b>RACS3227</b>           | 99105-20005     | 593         |
| <b>REC06192-ZY3-000</b>   | HZY3-06192-000  | 605         |
| <b>REC06192-ZY6-000</b>   | HZY6-06192-000  | 605         |
| <b>REC09401-11425</b>     |                 | 591         |
| <b>REC09401-11425BULK</b> |                 | 591         |
| <b>REC10W30U3</b>         |                 | 595         |
| <b>REC10W30U6</b>         |                 | 595         |
| <b>REC10W40U3</b>         | 990C0-10W40-GLN | 595         |
| <b>REC10W40U6</b>         | 990C0-10W40-GLN | 595         |
| <b>REC15400-PLM-A01PE</b> | HPLM-15400-PE   | 596         |
| <b>REC16157</b>           | 369-65011-0     | 605         |
| <b>REC16159</b>           | 369-65025-0     | 605         |
| <b>REC16253</b>           | 369-03231-0     | 597         |
| <b>REC162532</b>          | 3C8-03125-0     | 597         |
| <b>REC16275</b>           | 369-03303-0     | 596         |
| <b>REC16325</b>           | 369-03306-0     | 596         |
| <b>REC16911-ZY3-010</b>   | HZY3-16911-010  | 595         |
| <b>REC16911-ZZ5-003</b>   | HZZ5-16911-003  | 595         |
| <b>REC17109-ZY6-000</b>   | HZY6-17109-000  | 621         |
| <b>REC18-6865</b>         |                 | 602         |
| <b>REC19210-ZV5-003</b>   | HZV5-19210-003  | 604         |
| <b>REC19210-ZW1-B02</b>   | HZW1-19210-B04  | 604         |
| <b>REC19210-ZY3-003</b>   | HZY3-19210-003  | 604         |
| <b>REC19300-ZV5-043</b>   | HZV5-19300-043  | 603         |
| <b>REC22-8M0001721</b>    |                 | 591         |
| <b>REC24942</b>           |                 | 592         |
| <b>REC24950</b>           |                 | 593         |
| <b>REC24952</b>           |                 | 593         |
| <b>REC25000</b>           |                 | 592         |
| <b>REC25010</b>           |                 | 592         |
| <b>REC25020</b>           |                 | 592         |
| <b>REC25030</b>           |                 | 592         |
| <b>REC25W40U3</b>         |                 | 595         |
| <b>REC26-16051</b>        | 369-00122-0     | 608         |
| <b>REC26-161301</b>       | 346-60111-0     | 618         |
| <b>REC26-16162</b>        | 369-60223-0     | 618         |
| <b>REC26-161622</b>       | 346-65013-0     | 618         |
| <b>REC26-16703</b>        | 369-01215-0     | 618         |
| <b>REC26-803514</b>       | 101-00121-0     | 609         |
| <b>REC26-803667</b>       | 350-00121-0     | 618         |
| <b>REC26-85370711</b>     | 3B2-00051-0     | 609         |
| <b>REC26-8537072</b>      | 346-01215-0     | 618         |
| <b>REC27-16274</b>        | 369-03302-0     | 596         |
| <b>REC27-16326</b>        | 369-03307-0     | 596         |
| <b>REC27-8555691</b>      | 3C8-04028-0     | 596         |
| <b>REC2TU3</b>            |                 | 595         |
| <b>REC2TU6</b>            |                 | 595         |
| <b>REC30-16049</b>        | 9603-3-6204     | 608-609     |
| <b>REC30-160494</b>       | 96603-3-6305    | 610         |
| <b>REC30-16049T01</b>     | 345-00113-0     | 611         |
| <b>REC30-898101936</b>    | 9643-3-6004     | 619         |
| <b>REC30580-ZV4-013</b>   | HZV4-30580-013  | 599         |
| <b>REC309-01005-2</b>     | 309-01005-2     | 617         |
| <b>REC31-16052</b>        | 350-00042-0     | 608-610-619 |
| <b>REC31-8036752</b>      | 338-00042-0     | 609-619     |
| <b>REC31-813048</b>       | 369-00043-0     | 608         |
| <b>REC31-8130482</b>      | 356-00043-0     | 611         |
| <b>REC31-855553</b>       | 3C8-00113-0     | 612         |
| <b>REC31200-ZY6-003</b>   | HZY6-31200-003  | 601         |
| <b>REC345-00042-0</b>     | 345-00042-0     | 611-612-620 |
| <b>REC345-65021-0</b>     | 345-65021-0     | 604         |
| <b>REC346-01005-0</b>     | 346-01005-0     | 617         |
| <b>REC346-01303-0</b>     | 350-01303-0     | 618         |
| <b>REC35-802893Q</b>      |                 | 592         |
| <b>REC35-802893Q01</b>    | 3Y7-02234-0     | 592         |
| <b>REC35-80365M</b>       | 646-24251-02    | 595         |
| <b>REC350-01005-0</b>     | 350-01005-0     | 617         |
| <b>REC350-01303-0</b>     | 350-01303-0     | 618         |
| <b>REC350-61012-1</b>     | 350-61012-1     | 618         |
| <b>REC351-01005-0</b>     | 351-01005-0     | 617         |
| <b>REC353-06260-0</b>     | 353-06260-0     | 601         |
| <b>REC353-06260-0</b>     | 353-06260-2     | 601         |
| <b>REC35668-ZY6-003</b>   | HZY6-35668-003  | 598         |
| <b>REC369-06021-0</b>     | 369-06021-0     | 598         |
| <b>REC37510-PNB-003</b>   | HPNB-37510-003  | 598         |
| <b>REC39-16054A5</b>      | 346-00011-0     | 611-620     |
| <b>REC39-803678A1</b>     | 350-00011-0     | 610         |

| REF                       | R.O. / OEM   |                     |
|---------------------------|--------------|---------------------|
| <b>REC39-803678A3</b>     | 3B2-00011-0  | 609-619             |
| <b>REC39-8M0055809</b>    | 3V1-00011-0  | 615                 |
| <b>REC3A0-06040-1</b>     | 3A0-06040-1  | 599                 |
| <b>REC3A106-2602M</b>     | 3A106-2402M  | 601                 |
| <b>REC3A106-2602M</b>     | 3A106-2601M  | 601                 |
| <b>REC3A106-2602M</b>     | 3A106-2602M  | 601                 |
| <b>REC3B2-01005-0</b>     | 3B2-01005-0  | 617                 |
| <b>REC3B2-01303-0</b>     | 3B2-01303-0  | 618                 |
| <b>REC3B2-65021-1</b>     | 3B2-65021-1  | 604                 |
| <b>REC3B7-65021-2</b>     | 3B7-65021-2  | 604                 |
| <b>REC3B7-87121-1</b>     | 3B7-87121-7  | 617                 |
| <b>REC3C8-01005-4</b>     | 3C8-01005-4  | 617                 |
| <b>REC3C8-01024-0</b>     | 3C8-01024-0  | 617                 |
| <b>REC3C8-01303-4</b>     | 3C8-01303-4  | 618                 |
| <b>REC3C8-02104-0</b>     | 3C8-02104-0  | 621                 |
| <b>REC3C8-02305-0</b>     | 3C8-02305-0  | 621                 |
| <b>REC3F0-06060-0</b>     | 3F0-06060-0  | 601                 |
| <b>REC3F0-65029-6</b>     | 3F0-65029-6  | 605                 |
| <b>REC3F3-01005-0</b>     | 3F3-01005-0  | 617                 |
| <b>REC3F3-01024-0</b>     | 3F3-01024-0  | 617                 |
| <b>REC3F3-01303-1</b>     | 3F3-01303-1  | 618                 |
| <b>REC3F3-02104-0</b>     | 3F3-02104-0  | 621                 |
| <b>REC3F3-02305-1</b>     | 3F3-02305-1  | 604                 |
| <b>REC3G2-06040-2</b>     | 3G2-06040-2  | 599                 |
| <b>REC3G2-06060-2</b>     | 3G2-06060-2  | 601                 |
| <b>REC3G3-06021-1</b>     | 3G3-06021-1  | 598                 |
| <b>REC3T5-87121-6</b>     | 3T5-87121-6  | 617                 |
| <b>REC3T9-01005-0</b>     | 3T9-01005-0  | 617                 |
| <b>REC3T9-01032-0</b>     | 3T9-01032-0  | 604                 |
| <b>REC3T9-02104-0</b>     | 3T9-02104-0  | 621                 |
| <b>REC40135</b>           |              | 595                 |
| <b>REC40145</b>           |              | 595                 |
| <b>REC40155</b>           |              | 595                 |
| <b>REC40165</b>           |              | 595                 |
| <b>REC41-16056</b>        | 369-00021-0  | 608-619             |
| <b>REC41-16056</b>        | 3C8-00021-0  | 612                 |
| <b>REC41-803680002</b>    | 350-00021-0  | 610-619             |
| <b>REC41-803680003</b>    | 3C8-00021-0  | 611-620             |
| <b>REC41-8036801</b>      | 3B2-00021-0  | 609-619             |
| <b>REC41-825713002</b>    | 332-00021-0  | 610-619             |
| <b>REC43-16138</b>        | 309-64020-0  | 626                 |
| <b>REC43-803739</b>       | 350-06401-0  | 626                 |
| <b>REC43-803739T03</b>    | 3H8-640100   | 626                 |
| <b>REC43-803740</b>       | 350-06401-0  | 626                 |
| <b>REC43-803740T02</b>    | 3H8-64020-0  | 626                 |
| <b>REC43-803741</b>       | 362-64215-0  | 626                 |
| <b>REC43-803741T03</b>    | 3H8-64030-0  | 626                 |
| <b>REC43-812944</b>       | 369-64010-2  | 626                 |
| <b>REC43-8129451</b>      | 369-64030-2  | 626                 |
| <b>REC44-195133</b>       | 369-64211-1  | 626                 |
| <b>REC45-161351</b>       | 369-64301-0  | 626                 |
| <b>REC45-803738</b>       | 350-64301-0  | 626                 |
| <b>REC45-8037381</b>      | 350-64302-0  | 626                 |
| <b>REC53-16057</b>        | 334-00024-1  | 611-612-620         |
| <b>REC53-16057</b>        | 350-00024-1  | 608-609-610-619-620 |
| <b>REC5GH-13440-00</b>    | 3R3R76150M   | 589-596             |
| <b>REC5GH-13440-00</b>    | 3R0-07615-0  | 596                 |
| <b>REC5GH-13440-00</b>    | 5GH-13440-00 | 596                 |
| <b>REC5W40U3</b>          |              | 595                 |
| <b>REC5W40U6</b>          |              | 595                 |
| <b>REC629-803674</b>      | 350-00040-0  | 610-619             |
| <b>REC629-8036741</b>     | 3B2-00040-0  | 609-619             |
| <b>REC629-813047T01</b>   | 336-00040-1  | 611-620             |
| <b>REC650-24351-51</b>    |              | 591                 |
| <b>REC66M-W0093-01</b>    | 3V1-87122-0  | 597                 |
| <b>REC696-W0093-00</b>    | 345-87122-4  | 597                 |
| <b>REC6A1-W0093-01</b>    | 3F0-87122-2  | 597                 |
| <b>REC6E5-24351-51</b>    |              | 591                 |
| <b>REC6G1-W0093-00</b>    | 369-87122-1  | 597                 |
| <b>REC6G1-W0093-00</b>    | 3B2-87122-0  | 597                 |
| <b>REC6H1-W0093-01-00</b> | 346-87122-0  | 597                 |
| <b>REC6H3-W0093-02</b>    | 346-87122-0  | 597                 |
| <b>REC6H4-W0093-03</b>    | 3F3-87122-1  | 597                 |
| <b>REC6L2-W0093-00</b>    | 3G2-87122-2  | 597                 |
| <b>REC6L8-G3118-01</b>    | 332S62102-1  | 625                 |
| <b>REC70720</b>           |              | 594                 |
| <b>REC779-803677</b>      | 350-00001-0  | 619                 |
| <b>REC779-803677</b>      | 350-00001-1  | 610                 |
| <b>REC779-803677T02</b>   | 351-00001-1  | 610-619             |
| <b>REC779-804886</b>      | 3B2-00001-0  | 609-619             |
| <b>REC779-879194T01</b>   | 346-00001-1  | 611-620             |
| <b>REC779-96152</b>       | 3C8-00001-3  | 620                 |
| <b>REC779-9615T</b>       | 369-00001-0  | 608-619             |
| <b>REC779-9615T</b>       | 3C8-00001-3  | 612                 |
| <b>REC803673</b>          | 350-00061-0  | 610                 |

| REF                     | R.O. / OEM      |             |
|-------------------------|-----------------|-------------|
| <b>REC803751</b>        | 350-65011-1     | 605         |
| <b>REC804898</b>        | 3B2-63600-1     | 603         |
| <b>REC80W90U3</b>       | 990A0-01E81-01Q | 595         |
| <b>REC80W90U6</b>       | 990A0-01E81-01Q | 595         |
| <b>REC813046002</b>     | 369-00061-0     | 608         |
| <b>REC8130461</b>       | 334-00061-0     | 611         |
| <b>REC84419M</b>        | 345-87122-0     | 597         |
| <b>REC8537312</b>       | 350-04005-0     | 596         |
| <b>REC855676002</b>     | 3R3-01030-0     | 589-603     |
| <b>REC855686</b>        |                 | 592         |
| <b>REC879147796</b>     | 362-64211-0     | 626         |
| <b>REC8M0065585</b>     | 350-01215-5     | 618         |
| <b>REC8M0076368</b>     | 369-64301-0     | 626         |
| <b>REC8M0080349</b>     | 346-00011-0     | 612-620     |
| <b>REC8M0080357</b>     | 351-00011-0     | 608-610-619 |
| <b>REC90340-08002</b>   | 332-60005-2     | 623         |
| <b>REC90340-08020</b>   | 332-60006-0     | 623         |
| <b>REC90794-46866</b>   |                 | 594         |
| <b>REC90794-46868</b>   |                 | 594         |
| <b>RECOBBRACKET</b>     |                 | 592         |
| <b>RECOBELEMENT</b>     |                 | 593         |
| <b>RECOBFILALU</b>      |                 | 593         |
| <b>RECOBFILTER</b>      |                 | 593         |
| <b>RECYS-225-15</b>     |                 | 594         |
| <b>RM35-802893Q</b>     |                 | 592         |
| <b>RM92-858026QB1U6</b> |                 | 595         |
| <b>RM92-858027QB1U3</b> |                 | 595         |
| <b>RM92-8M0086220U6</b> |                 | 595         |
| <b>RM92-8M0086221U3</b> |                 | 595         |
| <b>S</b>                |                 |             |
| <b>SIE18-8013</b>       |                 | 590         |
| <b>SIE18-8015</b>       |                 | 590         |
| <b>SOL3411-130-19</b>   | 3C7-64554-0     | 628         |
| <b>SOL3411-130-21</b>   |                 | 628         |
| <b>SOL3411-133-17</b>   | 3C7-64541-0     | 628         |
| <b>SOL3411-135-15</b>   | 3C7-64536-0     | 628         |
| <b>SOL3411-138-13</b>   | 3B7-64527-1     | 628         |
| <b>SOL3411-140-11</b>   | 3B7-64523-1     | 628         |
| <b>SOL3413-125-19</b>   | 3C7-64554-0     | 628         |
| <b>SOL3413-125-21</b>   |                 | 628         |
| <b>SOL3413-128-17</b>   | 3C7-64541-0     | 628         |
| <b>SOL3413-130-15</b>   | 3C7-64536-0     | 628         |
| <b>SOL3413-133-13</b>   | 3B7-64527-1     | 628         |
| <b>SOL3431-130-19</b>   | 3C7-64554-0     | 628         |
| <b>SOL3431-130-21</b>   |                 | 628         |
| <b>SOL3431-133-17</b>   | 3C7-64541-0     | 628         |
| <b>SOL3431-135-15</b>   | 3C7-64536-0     | 628         |
| <b>SOL5011-078-07</b>   |                 | 628         |
| <b>SOL5011-078-08</b>   |                 | 628         |
| <b>SOL5011-085-07</b>   | 3B2-64513-0     | 628         |
| <b>SOL5011-085-08</b>   | 3B2-64515-0     | 628         |
| <b>SOL5011-085-09</b>   | 3B2-64517-0     | 628         |
| <b>SOL5111-093-07</b>   | 362-64105-0     | 628         |
| <b>SOL5111-093-08</b>   | 362-64103-0     | 628         |
| <b>SOL5111-093-09</b>   | 362-64101-0     | 628         |
| <b>SOL5111-093-10</b>   | 362-64108-0     | 628         |
| <b>SOL5111-093-11</b>   |                 | 628         |
| <b>SOL5211-099-09</b>   | 346-64101-5     | 628         |
| <b>SOL5211-099-10</b>   | 346-64102-5     | 628         |
| <b>SOL5211-099-11</b>   | 346-64103-5     | 628         |
| <b>SOL5211-099-12</b>   |                 | 628         |
| <b>SOL5211-099-13</b>   | 346-64104-5     | 628         |
| <b>SOL5311-110-15</b>   | 3E3-64536-0     | 628         |
| <b>SOL5311-110-16</b>   |                 | 628         |
| <b>SOL5311-110-17</b>   |                 | 628         |
| <b>SOL5311-111-13</b>   | 3E3-64528-0     | 628         |
| <b>SOL5311-111-14</b>   | 3E3-64536-0     | 628         |
| <b>SOL5311-114-12</b>   | 348-64103-0     | 628         |
| <b>SOL5311-116-11</b>   | 348-64102-0     | 628         |
| <b>SOL5311-121-09</b>   | 361-64114-0     | 628         |
| <b>SOL5311-122-07</b>   |                 | 628         |
| <b>SOL5313-105-13</b>   | 361-64113-0     | 628         |
| <b>SOL5313-105-14</b>   | 3E3-64528-0     | 628         |
| <b>SOL5313-108-12</b>   | 348-64103-0     | 628         |
| <b>SOL5313-111-11</b>   | 348-64102-0     | 628         |
| <b>SOL5313-118-09</b>   | 361-64114-0     | 628         |
| <b>SOL9311-111-13</b>   |                 | 629         |
| <b>SOL9311-114-12</b>   |                 | 629         |
| <b>SOL9411-132-19</b>   |                 | 629         |
| <b>SOL9411-132-21</b>   |                 | 629         |
| <b>SOL9411-133-17</b>   |                 | 629         |
| <b>SOL9411-135-15</b>   |                 | 629         |
| <b>SOL9411-138-13</b>   |                 | 629         |
| <b>SOL9411-140-09</b>   |                 | 629         |
| <b>SOL9411-140-11</b>   |                 | 629         |

| REF            | R.O. / OEM | REF            | R.O. / OEM           |
|----------------|------------|----------------|----------------------|
| SOL9431-130-19 | 629        | SOL9571-148-23 | 629                  |
| SOL9431-130-21 | 629        | SOL9571-150-21 | 629                  |
| SOL9431-133-17 | 629        | SOL9571-153-19 | 629                  |
| SOL9431-135-15 | 629        | SOL9571-155-17 | 629                  |
| SOL9431-138-13 | 629        | SOL9571-158-15 | 629                  |
| SOL9432-130-19 | 629        | SOL9572-148-23 | 629                  |
| SOL9432-133-17 | 629        | SOL9572-150-21 | 629                  |
| SOL9432-135-15 | 629        | SOL9572-153-19 | 629                  |
| SOL9432-138-13 | 629        | SOL9572-155-17 | 629                  |
| SOL9511-143-21 | 629        | SOL9572-158-15 | 629                  |
| SOL9511-145-19 | 629        | SOLRBX-109     | 629                  |
| SOL9511-148-17 | 629        | SOLRBX-112     | 629                  |
| SOL9511-150-15 | 629        | SOLRBX-116     | 629                  |
| SOL9511-153-13 | 629        |                |                      |
| SOL9511-155-11 | 629        | TEN01250       | 338-60218-2 589-607  |
| SOL9511-160-13 | 629        | TEN01251       | 369-60218-1 607      |
| SOL9531-140-19 | 629        | TEN01252       | 348-60217-0 607      |
| SOL9512-143-21 | 629        | TEN01253       | 3C8-60217-1 589-607  |
| SOL9512-145-19 | 629        | TEN01254       | 3C7-60218-2 607      |
| SOL9512-148-17 | 629        | TEN01255       | 3B7-60217-0 607      |
| SOL9512-150-15 | 629        | TEN01256       | 3B7-60218-1 589-607  |
| SOL9531-140-21 | 629        | TEN01257       | 3M2-60218-0 607      |
| SOL9531-140-23 | 629        | TEN01258       | 5338602182A0 589-607 |
| SOL9531-143-17 | 629        | TEN01259       | 3H6-60218-0 589-607  |
| SOL9531-145-15 | 629        | TEN01260       | 3B7-60217-0 589-607  |
| SOL9532-140-19 | 629        | TEN01408       | HZV4-12155-A00 607   |
| SOL9532-140-21 | 629        | TEN01408/1     | HZV5-12155-000 607   |
| SOL9532-140-23 | 629        | TRI305-0386    | 590                  |
| SOL9532-143-17 | 629        | TRI305-0566    | 590                  |
| SOL9532-145-15 | 629        |                |                      |

**RO / OEM --> REF**

| R.O. / OEM  | REF              | R.O. / OEM   | REF                | R.O. / OEM          | REF                      |
|-------------|------------------|--------------|--------------------|---------------------|--------------------------|
| 101-00121-0 | REC26-803514     | 346-64102-5  | SOL5211-099-10     | 351-00011-0         | REC8M0080357 608-610-619 |
| 172-36008-0 | PAF8-05000003    | 346-64103-5  | SOL5211-099-11     | 351-01005-0         | REC351-01005-0 617       |
| 309-00131-0 | PAT3.6-04000006  | 346-64104-5  | SOL5211-099-13     | 353-06260-0         | REC353-06260-0 601       |
| 309-01005-2 | REC309-01005-2   | 346-65013-0  | REC26-161622       | 353-06260-2         | REC353-06260-0 601       |
| 309-60111-0 | PAF8-04000101    | 346-67114-0  | PAF8-05000018      | 353-76010-4         | PH130-0048 600           |
| 309-64020-0 | REC43-16138      | 346-76010-0M | PH130-0080         | 356-00043-0         | REC31-8130482 611        |
| 309-65021-1 | CEF500396        | 346-87122-0  | REC6H1-W0093-01-00 | 361-64113-0         | SOL5311-122-08 628       |
| 332-00021-0 | PAF8-05020105    | 346-87122-0  | REC6H3-W0093-02    | 361-64114-0         | SOL5311-121-09 628       |
| 332-00021-0 | REC41-825713002  | 348-60217-0  | CM348-60217-0M     | 361-64114-0         | SOL5313-118-09 628       |
| 332-00024-0 | PAF8-05020105    | 348-60217-0  | TEN01252           | 362-64101-0         | SOL5111-093-09 628       |
| 332-60005-2 | REC90340-08002   | 348-64102-0  | SOL5311-116-11     | 362-64103-0         | SOL5111-093-08 628       |
| 332-60006-0 | REC90430-08020   | 348-64102-0  | SOL5313-111-11     | 362-64105-0         | SOL5111-093-07 628       |
| 332-62101-0 | PAF4-01010003    | 348-64103-0  | SOL5311-114-12     | 362-64108-0         | SOL5111-093-10 628       |
| 332S62102-1 | REC6L8-G3118-01  | 348-64103-0  | SOL5313-108-12     | 362-64211-0         | REC879147T96 626         |
| 334-00024-1 | REC53-16057      | 350-00001-0  | REC779-803677      | 362-64215-0         | REC43-803741 626         |
| 334-00061-0 | REC8130461       | 350-00001-1  | REC779-803677      | 369-00001-0         | REC779-9615T 608-619     |
| 334-65021-0 | CEF500383        | 350-00011-0  | REC39-803678A1     | 369-00021-0         | REC41-16056 608-619      |
| 336-00040-1 | REC629-813047T01 | 350-00021-0  | REC41-803680002    | 369-00043-0         | REC31-813048 608         |
| 338-00042-0 | REC31-8036752    | 350-00024-1  | PAF15-07020005     | 369-00061-0         | REC813046002 608         |
| 338-60218-2 | CM33860-2181     | 350-00024-1  | REC53-16057        | 608-609-610-619-620 | REC26-16051 608          |
| 338-60218-2 | TEN01250         | 350-00040-0  | REC629-803674      | 369-00132-0         | PAF8-05000024 613        |
| 344-67177-0 | PAGB/T7940.1-M6  | 350-00042-0  | REC31-16052        | 369-01215-0         | REC26-16703 618          |
| 345-00042-0 | REC345-00042-0   | 350-00061-0  | REC803673          | 369-02230-0         | PAF4-05000300 595        |
| 345-00113-0 | REC30-16049T01   | 350-00121-0  | REC26-803667       | 369-03231-0         | REC16253 597             |
| 345-62441-0 | PAF8-01000100    | 350-01005-0  | REC350-01005-0     | 369-03302-0         | REC27-16274 596          |
| 345-65015-0 | PAF8-04040002    | 350-01215-5  | REC8M0065585       | 369-03303-0         | REC16275 596             |
| 345-65021-0 | CEF500382        | 350-01303-0  | REC346-01303-0     | 369-03306-0         | REC16325 596             |
| 345-65021-0 | REC345-65021-0   | 350-01303-0  | REC350-01303-0     | 369-03307-0         | REC27-16326 596          |
| 345-65021-1 | CEF500379        | 350-04005-0  | REC8537312         | 369-06021-0         | REC369-06021-0 598       |
| 345-87122-0 | REC84419M        | 350-06401-0  | REC43-803739       | 369-60111-0         | PAF8-04040004 623        |
| 345-87122-4 | REC696-W0093-00  | 350-06401-0  | REC43-803740       | 369-60218-1         | TEN01251 607             |
| 346-00001-1 | REC779-879194T01 | 350-61012-1  | REC350-61012-1     | 369-60223-0         | REC26-16162 618          |
| 346-00011-0 | REC39-16054A5    | 350-62121-1  | PAF8-01010200      | 369-62122-2         | PAF8-01010200 625        |
| 346-00011-0 | REC8M0080349     | 350-62415-0  | PAJASOF40435-022   | 369-62439-1         | PAF8-01010105 625        |
| 346-01005-0 | REC346-01005-0   | 350-62417-0  | PAF8-01000002      | 369-64010-2         | REC43-812944 626         |
| 346-01032-0 | PAF8-05010005    | 350-62423-0  | PAF8-01000001      | 369-64014-0         | PAF8-04000012-1 623      |
| 346-01215-0 | REC26-8537072    | 350-64301-0  | REC45-803738       | 369-64015-0         | PAF8-04000012-2 623      |
| 346-02230-0 | PAF4-05000300    | 350-64302-0  | REC45-8037381      | 369-64030-2         | REC43-8129451 626        |
| 346-60111-0 | REC26-161301     | 350-65011-1  | REC803751          | 369-64032-0         | PAF8-04000012 623        |
| 346-62421-1 | PAF8-01010102    | 350-76010-0  | PH130-0061         | 369-64121-0         | PAF15-06000016 623       |
| 346-64101-5 | SOL5211-099-09   | 351-00001-1  | REC779-803677T02   | 369-64211-1         | REC44-195133 626         |

| R.O. / OEM   | REF             |         | R.O. / OEM  | REF              |         | R.O. / OEM   | REF              |         |
|--------------|-----------------|---------|-------------|------------------|---------|--------------|------------------|---------|
| 369-64223-0  | PAF8-04000305   | 623     | 3B7-65021-2 | REC3B7-65021-2   | 604     | 3R3R76150M   | REC5GH-13440-00  | 589-596 |
| 369-64301-0  | REC45-161351    | 626     | 3B7-87121-7 | REC3B7-87121-1   | 617     | 3T5-06920-0  | PAF8-05000011    | 613     |
| 369-64301-0  | REC8M0076368    | 626     | 3C7-60218-2 | TEN01254         | 607     | 3T5-10131-0  | PAF4-04000019    | 615     |
| 369-65011-0  | REC16157        | 605     | 3C7-64536-0 | SOL3411-135-15   | 628     | 3T5-87121-6  | REC3T5-87121-6   | 617     |
| 369-65021-1  | CEF500377       | 589-604 | 3C7-64536-0 | SOL3413-130-15   | 628     | 3T9-01005-0  | REC3T9-01005-0   | 617     |
| 369-65025-0  | REC16159        | 605     | 3C7-64536-0 | SOL3431-135-15   | 628     | 3T9-01032-0  | REC3T9-01032-0   | 604     |
| 369-66112-1  | PAF8-01010104   | 625     | 3C7-64541-0 | SOL3411-133-17   | 628     | 3T9-02104-0  | REC3T9-02104-0   | 621     |
| 369-84398-0  | PAF8-05000025   | 615     | 3C7-64541-0 | SOL3413-128-17   | 628     | 3V1-00001-0  | PAF8-05020101    | 615-620 |
| 369-87122-1  | REC6G1-W0093-00 | 597     | 3C7-64541-0 | SOL3431-133-17   | 628     | 3V1-00011-0  | REC39-8M0055809  | 615     |
| 393-62437-0  | PAF8-01010103   | 625     | 3C7-64554-0 | SOL3411-130-19   | 628     | 3V1-00030-1  | PAF8-05020001    | 615     |
| 394-702500M  | GS31015         | 592     | 3C7-64554-0 | SOL3413-125-19   | 628     | 3V1-00040-0  | PAF8-05020200    | 615-620 |
| 398-62103-0  | PAF4-01010002   | 625     | 3C7-64554-0 | SOL3431-130-19   | 628     | 3V1-00121-0  | PAF8-05010012    | 615     |
| 3A0-06040-1  | REC3A0-06040-1  | 599     | 3C7-65021-1 | CEF500388        | 604     | 3V1-01024-0  | PAF8-05000002    | 615     |
| 3A0-76079-0  | PAF8-05000006   | 613     | 3C7760-2181 | CM3C760-2181     | 606     | 3V1-01303-0  | PAF8-00000004    | 615     |
| 3A106-2402M  | REC3A106-2602M  | 601     | 3C7760-2181 | CM3C760-2181A    | 606     | 3V1-02010-1  | PAF8-05000008    | 615     |
| 3A106-2601M  | REC3A106-2602M  | 601     | 3C8-00001-3 | REC779-96152     | 620     | 3V1-02011-0  | PAF15-07000017   | 615     |
| 3A106-2602M  | REC3A106-2602M  | 601     | 3C8-00001-3 | REC779-9615T     | 612     | 3V1-02104-0  | PAF8-05000009    | 615     |
| 3AA-05004-0  | PAF8-05050004   | 616     | 3C8-00021-0 | REC41-16056      | 612     | 3V1-02305-0  | PAF8-05000100    | 615     |
| 3AA-05013-0  | PAF8-05050018   | 616     | 3C8-00021-0 | REC41-803680003  | 611-620 | 3V1-02305-0  | PAF8-05010004    | 615     |
| 3AA-05019-0  | PAF4-04130101   | 616     | 3C8-00113-0 | REC31-855553     | 612     | 3V1-03952-0  | PAF15-07000018   | 615     |
| 3AA-06021-0  | PAF8-05000300   | 598-613 | 3C8-01005-4 | REC3C8-01005-4   | 617     | 3V1-05104-1  | PAF8-05050005    | 616     |
| 3AA-06060-0  | PAF8-05000400   | 613     | 3C8-01024-0 | REC3C8-01024-0   | 617     | 3V1-05259-0  | PAF8-05050002    | 616     |
| 3AA-06060-00 | PAF8-05000400   | 601     | 3C8-01303-4 | REC3C8-01303-4   | 618     | 3V1-06023-0  | PAF8-05090000W   | 599     |
| 3AA060600M   | PAF8-05000400   | 601     | 3C8-02104-0 | REC3C8-02104-0   | 621     | 3V1-06040-0  | PAF8-05000500    | 599-613 |
| 3AA-06091-0  | PAF8-05000600   | 613     | 3C8-02305-0 | REC3C8-02305-0   | 621     | 3V1060400    | PAF8-05000500    | 599     |
| 3AA-07203-0  | PAF8-05030005   | 615     | 3C8-03125-0 | REC162532        | 597     | 3V1060400M   | PAF8-05000500    | 599     |
| 3AA-07225-0  | PAF8-05030009   | 615     | 3C8-04028-0 | REC27-8555691    | 596     | 3V1-06071-0  | PAF8-05000200    | 599-613 |
| 3AA760100    | PH130-0061      | 600     | 3C8-60217-1 | CM3C8-60217-0    | 606     | 3V1-06302-0  | PAF8-05000013    | 616     |
| 3AC-02230-0  | PAF15-07080000  | 594     | 3C8-60217-1 | TEN01253         | 589-607 | 3V1-06308-0  | PAF8-05000012    | 616     |
| 3AD-02230-0  | PAF15-07080000  | 594     | 3C8-62104-1 | PAF4-01010005    | 625     | 3V1-07010-0  | PAF8-05030008    | 615     |
| 3B1-66145-0  | PAF8-03010007   | 623     | 3C8-66116-0 | PAF8-03010006    | 623     | 3V1-07201-0  | PAF8-05030001    | 615     |
| 3B2-00001-0  | REC779-804886   | 609-619 | 3C8-76010-1 | PH130-0006       | 600     | 3V1-07202-0  | PAF8-05030002    | 615     |
| 3B2-00011-0  | REC39-803678A3  | 609-619 | 3C8-76010-1 | PH130-0006       | 600     | 3V1-07205-0  | PAF8-05030004    | 615     |
| 3B2-00021-0  | REC41-8036801   | 609-619 | 3C8760101M  | PH130-0006       | 600     | 3V1-07221-0  | PAF8-05030006    | 615     |
| 3B2-00040-0  | REC629-8036741  | 609-619 | 3E3-64528-0 | SOL5311-111-13   | 628     | 3V1-07235-0  | PAF8-05030200    | 615     |
| 3B2-00051-0  | REC26-85370711  | 609     | 3E3-64528-0 | SOL5313-105-13   | 628     | 3V1-07407-0  | PAF8-05010009    | 615     |
| 3B2-01005-0  | REC3B2-01005-0  | 617     | 3E3-64536-0 | SOL5311-110-15   | 628     | 3V1-07410-0  | PAF8-05000800    | 615     |
| 3B2-01215-0  | PAF8-02000002   | 625     | 3E3-64536-0 | SOL5311-111-14   | 628     | 3V1-07421-0  | PAF8-00000200    | 615     |
| 3B2-01303-0  | REC3B2-01303-0  | 618     | 3E3-64536-0 | SOL5313-105-14   | 628     | 3V1-07440-0  | PAF8-02000003    | 625     |
| 3B2-63600-1  | REC804898       | 603     | 3F0-06060-0 | REC3F0-06060-0   | 601     | 3V1-07600-0  | PAF8-05030300    | 615     |
| 3B2-64010-0  | PAF8-04010000   | 623-626 | 3F0-65029-6 | REC3F0-65029-6   | 605     | 3V1-07653-0  | PAF8-05030012    | 615     |
| 3B2-64020-0  | PAF8-04000003   | 623-626 | 3F0-87122-2 | REC6A1-W0093-01  | 597     | 3V1-10045-0  | PAF8-05000004    | 589-615 |
| 3B2-64023-0  | PAF8-04000004-1 | 623     | 3F3-01005-0 | REC3F3-01005-0   | 617     | 3V1-10060-0  | PAF8-05010014    | 615     |
| 3B2-64030-0  | PAF8-04000014   | 623-626 | 3F3-01024-0 | REC3F3-01024-0   | 617     | 3V1-10063-0  | PAF8-05010015    | 615     |
| 3B2-64215-0  | PAF8-04000303   | 623-626 | 3F3-01303-1 | REC3F3-01303-1   | 618     | 3V1-10068-0  | PAF8-05010016    | 615     |
| 3B2-64230-1  | PAF8-04000019   | 623     | 3F3-02104-0 | REC3F3-02104-0   | 621     | 3V1-60041-0  | PAF8-04000016    | 623     |
| 3B2-64513-0  | SOL5011-085-07  | 628     | 3F3-02305-1 | REC3F3-02305-1   | 604     | 3V1-60042-0  | PAF8-04000015    | 623     |
| 3B2-64515-0  | SOL5011-085-08  | 628     | 3F3-87122-1 | REC6H4-W0093-03  | 597     | 3V1-60211-0  | PANSKFJ-1516     | 623     |
| 3B2-64517-0  | SOL5011-085-09  | 628     | 3G2-06040-2 | REC3G2-06040-2   | 599     | 3V1-61208-0  | PAF8-02000005    | 625     |
| 3B2-65011-0  | PAF8-04000010   | 605-623 | 3G2-06060-2 | REC3G2-06060-2   | 601     | 3V1-61220-0  | PAF8-02000004    | 625     |
| 3B2-65016-0  | PAF8-04000009   | 623     | 3G2-87122-2 | REC6L2-W0093-00  | 597     | 3V1-61301-1  | PAF8-02000100    | 625     |
| 3B2-65016-0  | PAF8-04000013   | 623     | 3G3-06021-1 | REC3G3-06021-1   | 598     | 3V1-61302-0  | PAF8-00000002    | 625     |
| 3B2-65018-0  | PAF8-04000008   | 623     | 3H6-07223-0 | PAF8-05030007    | 615     | 3V1-61313-0  | PAF8-01000003    | 625     |
| 3B2-65020-0  | PAF8-04000005   | 623     | 3H6-07611-0 | PAF15-07010100   | 598-613 | 3V1-61324-0  | PAGB/T889.1-M8   | 625     |
| 3B2-65021-1  | CEF500344       | 589-604 | 3H6-07612-0 | PAF15-07010101   | 613     | 3V1-61333-1  | PAF8-00000100    | 625     |
| 3B2-65021-1  | PAF8-04000200   | 623     | 3H6-60218-0 | CM3H6-60218-000  | 606     | 3V1-63508-0  | PAF8-05000020    | 623     |
| 3B2-65021-1  | REC3B2-65021-1  | 604     | 3H6-60218-0 | CM3H6-60218-000A | 606     | 3V1-63622-0  | PAF8-05000019    | 623     |
| 3B2-65022-0  | PAF8-04000021   | 623     | 3H6-60218-0 | TEN01259         | 589-607 | 3V1-64211-0  | PAF8-04000301    | 623-626 |
| 3B2-65025-0  | PAF8-04000007   | 605-623 | 3H8-02093-0 | PAF8-05010002    | 615     | 3V1-64221-0  | PAF8-04000302    | 623     |
| 3B2-65029-0  | PAF8-04000006   | 623     | 3H8-07025-0 | PAF8-05030011    | 615     | 3V1-64306-1  | PAF8-04020001S   | 623-626 |
| 3B2-66113-0  | PAF8-03010005   | 623     | 3H8-07226-0 | PAF8-005030010   | 615     | 3V1-64307-1  | PAF8-04020001L   | 623-626 |
| 3B2-66315-0  | PAF8-01010109   | 625     | 3H8-07237-0 | PAF15-07040304   | 615     | 3V1-65100-0  | PAF8-02000006(S) | 625     |
| 3B2-66321-1  | PAF8-01010108   | 625     | 3H8-10062-2 | PAF8-05030400    | 615     | 3V1-65110-0  | PAF8-02000006(L) | 625     |
| 3B2-702501M  | GS31088         | 591     | 3H8-640100  | REC43-803739T03  | 626     | 3V1-65203-0  | PAF8-02000009    | 625     |
| 3B2-702601M  | GS31018         | 592     | 3H8-64020-0 | REC43-803740T02  | 626     | 3V1-65206-0  | PAF8-02000007    | 625     |
| 3B2-702801M  | GS31016         | 592     | 3H8-64030-0 | REC43-803741T03  | 626     | 3V1-66187-0  | PAF8-030010001   | 623     |
| 3B2-87122-0  | REC6G1-W0093-00 | 597     | 3K9-05223-0 | PAF8-01010112    | 625     | 3V1-66211-0  | PAF8-03000010    | 623     |
| 3B2S60100-0  | PAF8-04040000   | 623     | 3M2-60218-0 | CM3M2-60218-1    | 606     | 3V1-66225-0  | PAF8-03010003    | 623     |
| 3B2S60101-0  | PAF8-04040001   | 623     | 3M2-60218-0 | TEN01257         | 607     | 3V1-66302-0  | PAF8-03000011    | 623     |
| 3B2W64517-0  | PAF8-04050000   | 623     | 3R0-07238-0 | PAF15-07040303   | 615     | 3V1-66313-0  | PAF8-01010106    | 625     |
| 3B7-02230-0  | PAF15-07080000  | 594     | 3R0-66308-0 | PAF8-05000021    | 613     | 3V1-87122-0  | REC66M-W0093-01  | 597     |
| 3B7-06305-0  | PAF8-05000007   | 613     | 3R1-05003-1 | PAF8-05050006    | 616     | 3V1602170    | CM3V1-60217-0A   | 606     |
| 3B7-60217-0  | CM3B7-602170    | 606     | 3R1-05007-0 | PAF8-05050009    | 616     | 3V1602170    | CM3V1-60217-0A   | 606     |
| 3B7-60217-0  | TEN01255        | 607     | 3R1-05012-0 | PAF8-05050007    | 616     | 3V1B01001-0  | PAF8-05030100    | 615     |
| 3B7-60217-0  | TEN01260        | 589-607 | 3R1-05125-0 | PAF8-05050003    | 616     | 3V1B01100-0  | PAF8-05010000    | 615     |
| 3B7-60218-1  | CM3B7-60218-0   | 606     | 3R1-05131-0 | PAF4-04130102    | 616     | 3V2-03100-2  | PAF8-05040000    | 596     |
| 3B7-60218-1  | TEN01256        | 589-607 | 3R3-01030-0 | REC855676002     | 589-603 | 3Y7-02234-0  | REC35-802893Q01  | 592     |
| 3B7-64523-1  | SOL3411-140-11  | 628     | 3R3-07227-0 | PAF8-05030015    | 615     | 5GH-13440-00 | REC5GH-13440-00  | 596     |
| 3B7-64527-1  | SOL3411-138-13  | 628     | 3R3-07405-1 | PAF15-04000002   | 625     | 5338602182A0 | CM5338602182A0   | 606     |
| 3B7-64527-1  | SOL3413-133-13  | 628     | 3R3-07406-0 | PAF15-04000003   | 625     | 5338602182A0 | CM5338602182A0A  | 606     |
| 3B7-65021-2  | CEF500388       | 604     | 3R3-61017-0 | PAF8-00000003    | 615     | 5338602182A0 | TEN01258         | 589-607 |



| R.O. / OEM      | REF                |         |
|-----------------|--------------------|---------|
| 646-24251-02    | REC35-80365M       | 595     |
| 910113-0830     | PAGB/T5783-M8X30   | 625     |
| 910184-5620     | PAGB/T5783-M6X20   | 625     |
| 910184-5620     | PAGB/T97.1-6       | 625     |
| 940113-0800     | PAF8-02000100      | 625     |
| 940121-1200     | PAT15-04000011     | 613     |
| 945303-0500     | PAGB/T896-5        | 625     |
| 9603-3-6204     | REC30-16049        | 608-609 |
| 9643-3-6004     | REC30-898101936    | 619     |
| 96603-3-6305    | REC30-160494       | 610     |
| 9701-1-1005     | NGKB7HS-10         | 600     |
| 9701-1-1006     | NGKB8HS-10         | 600     |
| 9701-1-1010     | NGKBP7HS-10        | 600     |
| 9701-1-1013     | NGKBPR6HS-10       | 600     |
| 9701-1-1014     | NGKBPR7HS-10       | 600     |
| 9701-1-1015     | NGKBR7HS-10        | 600     |
| 9701-1-1103     | NGKDCPR6E          | 589-600 |
| 9701-1-1110     | NGKBR8HS-10        | 600     |
| 9701-1-1111     | NGKIZFR6           | 600     |
| 9701-1-1121     | NGKIKR6G8          | 600     |
| 9791-1-1109     | NGKIZFR5J          | 600     |
| 98AB-5-0330     | PAF8-05000024      | 615     |
| 98AH10-0120     | PAF8-05000017      | 615     |
| 990A0-01E81-01Q | REC80W90U3         | 595     |
| 990A0-01E81-01Q | REC80W90U6         | 595     |
| 990C0-10W40-GLN | REC10W40U3         | 595     |
| 990C0-10W40-GLN | REC10W40U6         | 595     |
| 99998-OMA2      | GS31019            | 591     |
| HPLM-15400-PE   | REC15400-PLM-A01PE | 596     |
| HPNB-37510-003  | REC37510-PNB-003   | 598     |
| HZV4-12155-A00  | TEN01408           | 607     |
| HZV4-30580-013  | REC30580-ZV4-013   | 599     |
| HZV5-12155-000  | TEN01408/1         | 607     |
| HZV5-19210-003  | CEF500338          | 604     |
| HZV5-19210-003  | REC19210-ZV5-003   | 604     |
| HZV5-19300-043  | REC19300-ZV5-043   | 603     |
| HZW1-19210-B04  | CEF500337          | 604     |
| HZW1-19210-B04  | REC19210-ZW1-B02   | 604     |
| HZW9-19300-003  | PAF15-07000031     | 603     |
| HZY3-06192-000  | REC06192-ZY3-000   | 605     |
| HZY3-16911-010  | REC16911-ZY3-010   | 595     |
| HZY3-19210-003  | CEF500391          | 604     |
| HZY3-19210-003  | REC19210-ZY3-003   | 604     |
| HZY3-31200-003  | PH130-0070         | 601     |
| HZY6-06192-000  | REC06192-ZY6-000   | 605     |
| HZY6-17109-000  | REC17109-ZY6-000   | 621     |
| HZY6-31200-003  | REC31200-ZY6-003   | 601     |
| HZY6-35668-003  | REC35668-ZY6-003   | 598     |
| HZZ3-31909-003  | NGKLMAR6C-9        | 600     |
| HZZ5-16911-003  | REC16911-ZZ5-003   | 595     |